

# Seating

Revised February 2021



# PRICE LIST seating



# think global

## THE GLOBAL EDGE

### ERGONOMICS IN THE TOTAL OFFICE

- One stop shopping for a full range of office furniture.
- Seating, desks, tables, files, modular furniture, panels and accessories.
- Ergonomics, competitive pricing and built-in value.

### STRENGTH AND STABILITY

- Established in 1966.
- One of North America's largest office furniture manufacturers.
- Manufacturing and showrooms worldwide.

### QUICK SHIP - INSTOCK

- Thousands of products available in a 2 day quickship program.
- Hundreds of products in stock for immediate delivery.

### STRONG LOCAL REPRESENTATION

- Service and expert advice where you are, when you need it!

### MANUFACTURING CAPABILITY

- Vertical integration ensures "start to finish" control.
- Ongoing research and investment in new, innovative production technology.

### QUALITY ASSURANCE

- Quality Assurance Program is qualified by C.G.S.B. ISO9001 standards.
- On-site furniture testing facility.
- Product and components are tested to meet or exceed ANSI/BIFMA standards.

### ENVIRONMENTAL COMMITMENT

- Continuous development of "earth friendly" programs.
- One of the first molded foam manufacturers to create ozone friendly, CFC and HFC-free process.
- Seat and back pans are made from recyclable plastics and wood waste, enabling little waste and cost effective products.

## SYMBOL IDENTIFICATION

Each seating product with an RTA code identifies the assembly requirements.

**RTA 00** FULLY ASSEMBLED

**RTA 1** SIMPLE ASSEMBLY (No Tools Required)

Parts to Install:

- Casters
- Base
- Pneumatic Cylinder/Cover can

**RTA 2** MODEST ASSEMBLY (Tools Supplied, if necessary)

Parts to Install:

- Casters
- Base
- Pneumatic Cylinder/Cover can
- Back

**RTA 4** MODERATE ASSEMBLY (Tools Supplied)

Parts to Install:

- Casters
- Base
- Pneumatic Cylinder/Cover can
- Back
- Armrest

**RTA 8** FULL ASSEMBLY (Tools Supplied)

Parts to Install:

- Casters
- Base
- Pneumatic Cylinder/Cover can
- Back
- Armrest
- Mechanism



Global's Certified Products are in compliance with the stringent emission guidelines set by the GREENGUARD Environmental Institute and include all Upholstered Seating. To obtain a GREENGUARD or GREENGUARD Gold Certificate for any product, please go to the Environmental Commitment section on our website [www.globalfurnituregroup.com](http://www.globalfurnituregroup.com) and click on "GREENGUARD".



level™ certification, based on the ANSI/BIFMA e3-2012 furniture sustainability standard, sets furniture manufacturers on a path toward greater sustainability over time. Based on environmental and social criteria set forth in the standard, a product's entire supply chain is assessed.

Certification assessment includes an evaluation of specific corporate policies and guidelines and an assessment of associated company manufacturing facilities. Products must meet quantifiable milestones of environmental and social performance at every step of development.

The quantitative assessment addresses four categories: material use, energy and atmosphere impacts, human and ecosystem health and social responsibility.

Manufacturers earn points in each of the four categories. The level™ brand and its numeric rating of 1, 2 or 3 indicate what threshold of certification a product has achieved. level™ 3 is the highest rating.



All products with this designation are suitable for UPS shipment throughout the United States.



# TABLE OF CONTENTS

## A

Academic Task .....	379
Alero .....	22
Arno .....	27
Arturo .....	28
Aspen .....	29
Auburn .....	31

## B

Bakhita .....	134
Ballara .....	240
Beach .....	137
Beam Seating .....	138
Braden Braden .....	285
Bridges II Collaborative Seating .....	254

## C

Camino .....	261
Caprice .....	148
Chap .....	150
Citi .....	266
Citi Square .....	271
Comet .....	152
Concorde .....	32

## D

Dawson .....	280
Diplomat .....	34
Drift .....	281
Duet .....	156
Duet tables .....	173

## E

Enterprise .....	35
------------------	----

## F

Factor .....	39
File Buddy .....	172

## G

G1 .....	41
G20 .....	43
Global Accord .....	44
Goal .....	47
Graham .....	49
Granada .....	50
Granada Deluxe TS .....	359
Granada Deluxe .....	55
Granada Deluxe TS .....	359
Graphic .....	59

## I

Industrial Seating .....	381
Industrial ESD .....	386
Industrial Clean Room .....	390
Industrial Anti-Microbial .....	395
Industrial Wipe Down .....	398
Islands .....	176

## J

Jeo .....	240
-----------	-----

## K

Kate .....	288
------------	-----

## L

Layne .....	177
Lite .....	179
Loover .....	62
Luray .....	66
Lux .....	289

## M

Malaga .....	68
Malaga TS .....	359
Marche .....	183
Max .....	69
Mayne .....	185
Mirage .....	70
ML .....	291
ML Park .....	293
Moda Four-Legged .....	186
Moda Stacking .....	187

## N

Novello .....	71
---------------	----

## O

ObusForme Comfort + XL .....	74
Orion .....	294

## P

Popcorn .....	189
Prairie .....	295
Prefer .....	80
Priority .....	82

## R

River .....	296
River+ .....	324
Roma .....	84
Roma Nester .....	194

## S

Sas .....	196
Sidero .....	198
Sirena .....	344
Softcurve .....	88
Solar .....	92
Solo .....	94
Sonic .....	202
Sora .....	96
Spritz .....	98
Spyker .....	219
Spritz multi-purpose .....	216
Stream .....	220
Supra .....	100
Supra X .....	102
Synopsis .....	105

## T

Tamiri .....	108
Traditional .....	111
Triumph .....	115
Truform .....	116
Twilight .....	228
Tye .....	119

## V

Vion .....	122
Vion guest .....	231
Vitrola .....	348

## W

Weev .....	129
Wind .....	350
Wind Linear .....	352

## Z

Zoma .....	237
Zoocy .....	238

## REFERENCES/PROGRAMS















Seating by Category Types .....	4-11
Suggested Applications by Series .....	12-13
Ergonomic Features and Benefits .....	14
Mechanism Adjustments .....	15
How to Order Seating .....	16
Act Performance Symbols .....	17
2 Day Lightning .....	14
How to select armrests .....	370
Arm selections .....	371
Caster selections .....	374
Cylinder chart .....	376
Duet + Popcorn glide selections .....	377
COM Authorization Form .....	409
Think Global - Think Green .....	409
Specialty Seating .....	360
Textiles + Finishes .....	404
Terms/Conditions/Warranty .....	410



# SEATING BY CATEGORY TYPE



## Task

 Alero .....22	 Luray .....66	 Supra .....100
 Aspen .....29	 Malaga .....68	 Supra X .....102
 Enterprise .....35	 Novello .....71	 Synopsis .....105
 Factor .....39	 ObusForme Comfort + XL .....74	 Tamiri .....108
 G1 .....41	 Prefer .....80	 Traditional .....111
 G20 .....43	 Priority .....82	 Triumph .....115
 Goal .....47	 Roma .....84	 Truform .....116
 Graham .....49	 Softcurve .....88	 Tye .....119
 Granada .....50	 Solar .....92	 Vion .....122
 Granada Deluxe .....55	 Solo .....94	 Weev .....129
 Graphic .....59	 Sora .....96	
 Loover .....62	 Spritz .....98	

Conference/Management



Arno .....27



Arturo .....28



Diplomat .....34



Enterprise .....35



Global Accord .....44



Graphic .....59



Jeo .....240



Kate .....288



Luray .....66



Max .....69



Mirage .....70



Priority .....82



Roma .....84



Softcurve .....88



Solar .....92



Solo .....94



Supra .....100



Synopsis .....105



Tamiri .....108













Traditional .....111





















# SEATING BY CATEGORY TYPE

## Executive

 Arno .....27	 Global Accord .....44	 Softcurve .....88
 Arturo .....28	 Luray .....66	 Tamiri .....108
 Auburn .....31	 Mirage .....70	 Traditional .....111
 Concorde .....32	 Priority .....82	











## Drafting Stools

 Aspen .....29	 Loover .....62	 Spritz .....98
 Global Accord .....44	 Malaga .....68	 Synopsis .....105
 Goal .....47	 Novello .....71	 Truform .....116
 Granada .....50	 ObusForme Comfort + XL .....74	 Tye .....119
 Granada Deluxe .....55	 Prefer .....80	 Vion .....122
 Graphic .....59	 Roma .....84	 Weev .....129
	 Solar .....92	















**MULTI-PURPOSE SEATING**

**Stacking**

 Bakhita .....134	 Popcorn .....189	 Stream .....220
 Comet .....152	 Sas .....196	 Vion guest .....231
 Duet .....156	 Sidero .....198	 Zoma .....237
	 Sonic .....202	
	 Spyker .....219	





**Guest (Metal)**

 Caprice .....148	 Marche .....183	 Stream .....220
 Comet .....152	 Popcorn .....189	 Twilight .....228
 Diplomat .....155	 Sidero .....198	 Vion guest .....231
 Lite .....179	 Sonic .....202	 Zooney .....238



# SEATING BY CATEGORY TYPE





## Guest (Wood)

 Beach .....137	 Islands .....176	 Mayne .....185
 Chap .....150	 Layne .....177	













## Nesting

 Roma Nester .....194	 Spritz Nester .....216
--	--

## Tandem/Beam

 Duet (Beam) .....143	 Sidero (Beam) .....145	 Vion (Beam) .....146
 Popcorn (Beam) .....144	 Sonic (Beam) .....145	Beam Seating .....138











## Stools

 Diplomat .....155	 ML .....291	 Sonic .....202
 Duet .....156	 Popcorn .....189	 Stream .....220
 File Buddy .....172	 Sas .....196	 Twilight .....228
 Marche .....183	 Sidero .....198	 Vion guest .....231





**EDUCATION**

**Classroom**

Academic Task .....379	 Novello .....71	 Sonic .....202
 Duet .....156	 Popcorn .....189	 Spritz Nester .....216
Duet tables .....173	 Roma Nester .....194	 Supra X .....102
 Graphic .....59	 Sidero .....198	 Vion .....122

**Work + Task**

 G1 .....41	 Novello .....71	 Spritz .....98
 Granada .....50	 ObusForme Comfort + XL .....74	 Supra X .....102
 Graphic .....59	 Prefer .....80	 Truform .....116
 Loover .....62	 Roma .....84	 Vion .....122
	 Sora .....96	





**Guest**

 Caprice .....148	 Islands .....176	 Sonic .....202
 Duet .....156	 Roma Nester .....194	 Vion guest .....231
 Graphic .....59	 Sidero .....198	 Zoma .....237



# SEATING BY CATEGORY TYPE

## Lecture Hall

 Duet (Beam) .....143	 Sidero (Beam) .....145	 Vion (Beam) .....146
 Popcorn (Beam) .....144	 Sonic (Beam) .....145	









## Lab Seating + Stools

 Caprice .....148	 Novello .....71	 Spritz .....98
 Duet .....156	 Sidero .....198	 Supra X .....102
 Graphic .....59	 Sonic .....202	 Vion .....122











## Cafeteria

 Bakhita .....134	 Sas .....196	 Sonic .....202
 Duet .....156	 Popcorn .....189	 Spyker .....219

## Lounge



















 BallaraSirena .....344	 Citi Square .....271	 River+ .....324
 Citi .....266	 Orion .....294	 SirenaBallara .....240
 Drift .....281	 River .....296	 Wind Linear .....352

## Stacking & Nesting

 Bakhita .....134	 Sas .....196	 Spyker .....219
 Duet .....156	 Sidero .....198	 Stream .....220
 Popcorn .....189	 Sonic .....202	 Zoma .....237
 Roma Nester .....194	 Spritz Nester .....216	



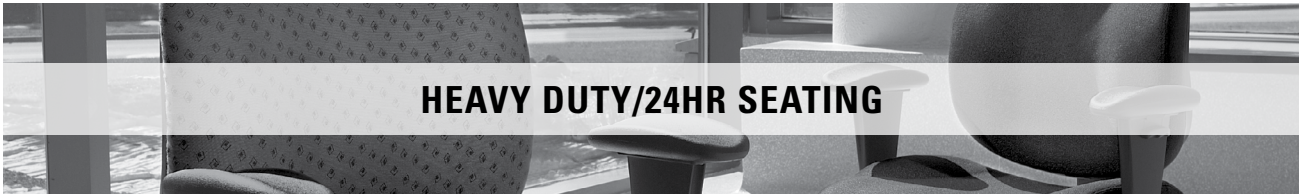

**LOUNGE SEATING**

 Ballara .....240	 Jeo .....240	 Prairie .....295
 Braden .....285	 Kate .....288	 River .....296
 Bridges II Collaborative Seating ..254	 Lux .....289	 River+ .....324
 Camino .....261	 ML .....291	 Sirena .....344
 Citi .....266	 ML Park .....293	 Vitrola .....348
 Drift .....281	 Orion .....294	 Wind .....350



**HEAVY DUTY/24HR SEATING**

 Concorde Executive 24HR .....362	 Granada Deluxe TS .....359	 Saxon .....367
 Dexter + Dexter Plus .....363	 Malaga TS .....359	 Truform TS .....361
 G1 Ergo Select TS .....364	 ObusForme Comfort TS .....360	 Vion TS .....368
 Granada TS .....358	 Robust .....366	

# SUGGESTED APPLICATIONS BY SERIES

SERIES	SUGGESTED APPLICATION	ACADEMIC SEATING	CAFETERIA SEATING	CONFERENCE ROOM SEATING	ERGONOMIC AND TASK	EXECUTIVE TASK SEATING	HEAVY DUTY SEATING	HOSPITALITY SEATING	GUEST SEATING	LOUNGE/RECEPTION SEATING	MANAGEMENT SEATING	MEETING ROOM SEATING	MULTI PURPOSE SEATING	PUBLIC SEATING	STACKING SEATING	STOODLS	TABLET SEATING	TECHNICAL SEATING	WOOD GUEST SEATING
ALERO				•	•														
ARNO			•					•		•									
ARTURO			•					•		•									
ASPEN				•	•											•			
AUBURN			•							•									
BAKHITA	•	•								•			•		•				
BALLARA										•						•			
BEACH								•	•				•						•
BEAM SEATING	•	•					•	•											
BRADEN										•									
BRIDGES II COLLAB. SEATING							•	•	•				•						
CAMINO							•	•	•										
CAPRICE								•					•				•		
CITI & CITI SQUARE								•	•				•				•		
COMET		•						•	•		•	•							
CONCORDE					•	•													
DEXTER & DEXTER PLUS						•				•									
DIPLOMAT								•		•							•		•
DUET	•	•								•			•		•	•	•		
ENTERPRISE			•	•				•		•									
FILE BUDDY													•			•			
G20				•	•					•	•								
GLOBAL ACCORD			•							•							•		
GOAL	•			•													•		
GRAHAM				•															
GRANADA & GRANADA DELUXE	•			•		•		•								•		•	
GRAPHIC			•								•					•			
ISLANDS							•	•											•
JEO								•	•				•						
KATE			•					•											
LAYNE							•	•											•
LITE	•	•					•	•	•				•						
LOOVER			•	•				•		•									
LURAY			•	•						•									
LUX							•	•											
MALAGA	•			•		•		•								•			
MARCHE							•	•			•					•			

# SUGGESTED APPLICATIONS BY SERIES

SERIES	SUGGESTED APPLICATION	ACADEMIC SEATING	CAFETERIA SEATING	CONFERENCE ROOM SEATING	ERGONOMIC AND TASK	EXECUTIVE TASK SEATING	HEAVY DUTY SEATING	HOSPITALITY SEATING	GUEST SEATING	LOUNGE/RECEPTION SEATING	MANAGEMENT SEATING	MEETING ROOM SEATING	MULTI PURPOSE SEATING	PUBLIC SEATING	STACKING SEATING	STOODS	TABLET SEATING	TECHNICAL SEATING	WOOD GUEST SEATING
MAX			•					•		•									
MAYNE							•	•											•
MIRAGE																			
ML		•					•	•	•							•			
ML PARK		•					•	•	•							•			
NOVELLO			•	•			•												
OBUSFORME COMFORT				•	•					•									
ORION				•	•	•		•	•										
POPCORN		•						•	•		•	•	•	•					
PRAIRIE									•										
PRIORITY			•					•		•									
RIVER							•	•	•				•						
ROBUST						•				•									
ROMA		•	•	•							•	•		•	•				
ROMA NESTER												•	•						
SAXON						•													
SIDERO		•					•	•				•		•	•				
SIRENA								•	•								•		
SOFTCURVE			•		•			•		•									
SOLAR			•	•			•												
SOLO			•					•		•									
SONIC		•						•	•		•	•	•		•	•			
SUPRA			•					•		•									
SUPRA X	•			•												•			
SYNOPSIS			•	•				•		•						•			
TAMIRI				•				•		•									
TRADITIONAL								•	•	•									
TRIUMPH					•					•									
TRUFORM				•		•				•						•			
TWILIGHT		•						•			•	•				•			
TYE			•	•				•		•						•			
VION			•	•	•	•		•		•					•	•			
WEEV			•	•						•						•			
WIND & WIND LINEAR									•										
ZOMA		•					•	•		•	•	•		•					
ZOOEY							•	•		•	•	•							

# ERGONOMIC FEATURES & BENEFITS

EACH GLOBAL CHAIR IS BUILT WITH FEATURES THAT ARE ERGONOMICALLY DESIGNED TO PROMOTE GOOD POSTURE AND PROVIDE MAXIMUM COMFORT. WHILE FULLY SUPPORTING YOUR BODY, THESE FEATURES SHOULD ALSO ALLOW YOU TO ADJUST YOUR CHAIR TO FIT YOU.



## A TENSION ADJUSTMENT

Increase or decrease to match body weight. Allows you to rock comfortably, without heavy pushing, reducing muscle fatigue.



## B CHAIR TILT LOCK

Lock the tilt movement in position(s) to accommodate your working posture. Allows you to lock your chair in a comfortable and supportive position. (Can be either single position or infinite style).



## C SEAT HEIGHT

Raise or lower to allow your feet to rest flat on the floor. Avoids pressure under your thighs, easing blood flow.



## D BACK HEIGHT

Raise or lower to position lumbar support in your lumbar area. Reduces likelihood of back pain.



## E SEAT DEPTH

Change the depth of the seat to accommodate the length of your thighs. Keeps your back in contact with the backrest while avoiding pressure behind your knees.



## F FORWARD SEAT ANGLE

Allows chair to tilt forward changing the angle of your thighs in relation to the floor. Helps reduce disc pressure during forward leaning tasks.



## G BACK ANGLE

Adjust to change the angle of your torso in relation to your thighs. Helps reduce disc pressure and relaxes your back muscles.



## H ARM HEIGHT

Raise or lower to support your forearms. Reduces muscular effort in neck and shoulders, minimizing risk of pain.



## J KNEE-TILT MOVEMENT

Chair tilt pivot point is toward the front of the seat. Stability is maintained as the user reclines, keeping their feet on the floor and maintaining the same torso to thigh angle.



## L SYNCHRO-TILT MOVEMENT

The seat pivots at the center point, while the backrest reclines at a faster rate than the seat, increasing the angle between the user's torso and thighs. Enhances comfort and encourages dynamic body movement.



## M WATERFALL SEAT EDGE

Reduces pressure at the back of the knee, contributing to good blood flow.



## N CONTOURED CUSHION

Supports the body effectively, allowing you to sit longer without discomfort.



## P VIBRATING SEAT & BACK

Soothing effect contributes to your relaxation during work breaks.



## Q WIDTH ADJUSTABLE ARMS

Allows outward movement of armrests to match shoulder breadth. Ensures armrests properly support forearms, reducing muscular efforts in neck and shoulders.



## R ARM ROTATION

Rotate armcaps to support your forearms in various positions. Reduces muscular effort in neck and shoulders minimizing risk of pain.



## S CENTER TILT

Chair tilts at the center point of the seat allowing you to recline while maintaining the same torso to thigh angle. When your feet are well supported, blood flow is enhanced.



## U SOFT DESCENT PNEUMATIC LIFT

Gently and gradually lowering the seat helps you easily select proper seat height without causing a jerking motion.



## V LUMBAR DEPTH ADJUSTMENT

Increase or decrease curvature of the back to match the profile of your lower back. Enhances comfort and support in the lower lumbar area.

## MAXIMIZING YOUR ERGONOMIC SEATING

- Always select a chair that is designed for the type of work you perform and make certain the chair is comfortable for the length of time spent using it.
- Ensure that the seat and back cushions are contoured to fit your body, which will help eliminate pressure points.
- An ergonomically designed chair should allow changing positions easily.
- As you work, reposition yourself throughout the day to reduce strain and stress on specific muscle groups. If you change job functions, adjust your chair to fit the new task.
- Proper ergonomic seating should help eliminate many of the work related injuries that result from poor posture and poorly designed chairs.

**TASK (-6)**



**ADJUSTMENTS**

- (2) Pneumatic seat height
- (8) Manual seat depth
- Back height \*\*
- Swivel

**POSTURE TASK (-7)**



**ADJUSTMENTS**

- (2) Pneumatic seat height
- (3) Back angle
- (6) Back height \*\*
- Seat depth \*
- Swivel

**TILTER (-4)**

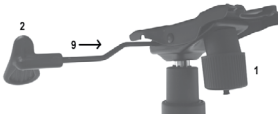

**ADJUSTMENTS**

- (2) Pneumatic seat height
- (9) Chair tilt lock \*
- Center-tilt action
- Swivel

**KNEE-TILTER (-2)**



**ADJUSTMENTS**

- (1) Tilt tension
- (2) Pneumatic seat height
- (9) Chair tilt-lock \*
- Back height \*\*
- Knee-tilt action
- Swivel
- Optional sliding seat depth adjustment (MD)

**MULTI-TILTER (-3)**



**ADJUSTMENTS**

- (1) Tilt tension
- (2) Pneumatic seat height
- (3) Back angle adjustment
- (9) Infinite position seat tilt lock
- (7) Forward tilt lock \*
- (8) Sliding seat depth adjustment (MD)
- Back height \*\*
- Center-tilt action
- Swivel

**SYNCHRO-TILTER (-0, -1, -8)**



**ADJUSTMENTS**

- (1) Tilt tension
- (2) Pneumatic seat height
- (3) Back angle adjustment
- (8) Sliding seat depth adjustment (MD)
- (9) Chair tilt lock Synchro-tilt action
- Anti-kickback \*
- Back height \*\*
- Swivel

**POSTURE-TILTER \***



**ADJUSTMENTS**

- (1) Tilt tension
- (2) Pneumatic seat height
- (8) Sliding seat depth adjustment (MD)
- (9) Infinite position seat tilt lock
- Back height \*\*
- Swivel

**OPERATOR (-5)**



**ADJUSTMENTS**

- (2) Pneumatic seat height
- (3) Back angle \*(Free Float/lock)
- (4) Seat angle \*(Free Float/lock)
- (4) Seat angle / Back angle
- Back height \*\*
- Free floating seat and back \*
- With single lever operator mechanism, seat and back angle are controlled using lever 4 \*
- Swivel

**NOTES**

- \* Selected models only.
- \*\* RATCHET back height adjustment on selected models.
- \*\*\* Mechanisms shown are generic depictions and may differ from one chair to another.

# HOW TO ORDER SEATING



**5451-3**

MODEL NUMBER

+



**MD**

MECHANISM OPTION

+



**BK**

FRAME FINISH

+



**AX27**

FABRIC CODE

## FABRIC CHAIR EXAMPLE

If there are any options for the chair they would be inserted between the Model Number with Arm Style and Frame Finish. For example (see above):

### 5451-3 BK AX27

This would be the **Tuform Medium Back Multi-Tilter** with standard Height Adjustable Arms and Multi-Tilter. Black Frame **BK** and Oxygen fabric in Axis, Noir **AX27**, complete the chair.

## LEATHER CHAIR EXAMPLE

If there are any options for the chair they would be inserted between the Model Number and Frame Finish. When ordering Leather Chairs you **MUST** include the Mock Leather color (for Grade 7). For example:

### 3966 BK 450/550

This would be the Troy High Back Tilter (with upholstered open arms) **3966** with, Black Frame **BK** and **450** Black Leather & **550** Black Mock Leather combination.

## CHAIR SAFETY TIPS

**Common sense guidelines to ensure that your Global chair will provide many years of comfort and service in a safe and productive environment:**

- Always read and follow assembly instructions. Make sure that all of the pieces of your Global chair are installed in the proper order to ensure structural integrity.
- Ensure that chair casters are fully inserted into the base of the unit.
- Inspect your chair for loose or worn parts at least once a year.
- Always keep the base of your chair completely on the floor.
- Most Global chairs are equipped with casters for use on carpeted surfaces. Other flooring surfaces may require different casters.
- Speak to your Global Sales Representative or refer to the Casters Section of this Price Book for appropriate custom selections.
- Many Global office chairs are equipped with tilt tension controls on the seating mechanism. The tension control compensates for different body weights and postures. Always ensure that the control is properly adjusted for a smooth and controlled tilt motion. Your Global Sales Representative can demonstrate the proper use of all the adjustments on your office chair.
- Do not stand on your Global chair or sit on the arms of your chair.
- Do not put electrical appliances on chairs. Even fire retardant fabrics can be damaged when exposed to direct heat or flame.
- Choose the right chair for your work environment. Global offers a full line of Intensive Use, Multi-Shift and Specialized chairs for environments with demanding health or safety requirements. Your Global Sales Representative is trained to help you make the right choice for your workplace.



THE ASSOCIATION FOR CONTRACT TEXTILES (ACT) HAS DEVELOPED THE FOLLOWING PERFORMANCE GUIDELINES TO MAKE FABRIC SPECIFICATION EASIER. THE FIVE SYMBOLS GIVE ARCHITECTS, DESIGNERS AND END USERS A VAST AMOUNT OF PERFORMANCE INFORMATION IN A SUCCINCT, VISUAL WAY. THIS CHART LISTS THE REQUIRED TESTS THAT CORRESPOND TO SPECIFIC END USES. AN EXPLANATION OF THE SYMBOL ALSO APPEARS.

## FIRE RETARDANCY



Flammability testing determines a fabric's performance and resistance to burning.

### APPLICATION

Upholstery  
Panels and upholstered walls

### PASSES

California bulletin 117, section E.  
ASTM E 84-03 Class A or Class 1 (unadhered method).

## COLOR FASTNESS TO WET & DRY CROCKING



Color fastness to wet & dry crocking refers to the rubbing off of color from the fabric onto clothing, hands or other materials and can occur under wet or dry conditions.

### APPLICATION

Upholstery  
Panels and upholstered walls

### PASSES

AATCC 8-2001 Dry crocking. Class 4 minimum.  
Wet crocking, Class 3 minimum.  
AATCC 8-2001 E 84 (unadhered method).

## COLOR FASTNESS TO LIGHT



Color fastness to light is the degree to which fabric will retain its color when exposed to light.

### APPLICATION

Upholstery  
Panels and upholstered walls

### PASSES

AATCC option 2-2003 or AATCC - option 3-2003.  
Class 4 minimum of 40 hours.  
AATCC option 2-2003 or AATCC - option 3-2003.  
Class 4 minimum of 40 hours.

## PHYSICAL PROPERTIES



Three physical property tests include: 1 - Brush pill test to determine a fabric's pilling (the formation of fuzzy galls of fiber on the surface of a fabric). 2 - Breaking/tensile strength is the ability of a fabric to withstand tension without breaking or tearing. 3 - Seam slippage is the pulling apart of fabrics at the seams.

### APPLICATION

Upholstery  
Panels and upholstered walls

### PASSES

Brush pill ASTM D3511-02, 3 minimum.  
Breaking strength ASTM D5034-95 (2001) 50 lbs. minimum in warp & weft.  
Seam slippage ASTM D4034 25 lbs. minimum in warp & weft.  
Breaking strength ASTM D5034-95 (2001) (grab test).  
35 lbs. minimum in warp & weft.

## ABRASION



Abrasion is the ability of a fabric to withstand damage from wear and rubbing. There is a general contract specification as well as a heavy duty specification.

### APPLICATION

General contract upholstery  
Heavy duty upholstery

### PASSES

ASTM D4157-02 (#10 cotton duck) 15,000 double rubs, Wyzenbeek method.  
ASTM D4966-98 (12 KPA pressure) 20,000 double rubs, Martindale method.  
ASTM D4157-02 (#10 cotton duck) 30,000 double rubs, Wyzenbeek method.  
ASTM D4966-98 (12 KPA pressure) 40,000 double rubs, Martindale method.

# 2 DAY LIGHTNING QUICKSHIP PROGRAM

2 DAY  
Lightning



Global's new 2 DAY LIGHTNING has been re-defined with many of our best selling models upholstered in your choice of our most popular textiles.

The 2 DAY LIGHTNING program features easy customization with extensive upholstery choices.

- 24 Series, 170+ Models, 300+ Textiles to Customize your order
- No Special Order Forms Required
- Everything is UPSable

**Need quick, simple and custom seating? Think Global!**

### Color it your way

#### GRADE 1

Carrera  
Fusion  
Illusion  
Jenny  
Quilt

Terrace  
Urban  
Waterfall  
Wavelength

#### GRADE 2

Allante FFree  
Couture  
Elevate  
Etch  
GC Linen Vinyl

Imprint  
Match  
Release Vinyl  
Replay  
Silhouette

#### GRADE 5

Genuine Leather/Mock Leather  
(for Accord, Synopsis, Triumph only)

#### GRADE 8

Genuine Leather  
(for Accord, Supra, Synopsis, Triumph only)

Textiles are subject to change, please confirm current selection.





















### TERMS AND CONDITIONS

- All product series have MAXIMUM order quantities which can be fulfilled within the 2 Day Lightning program. These are noted next to each series. For greater quantities, please contact CustomerCare for lead times and terms.
- Orders must clearly state, "2 Day Lightning" at the time of submittal
- Finished products will ship from our factories in as little as two business days
- Program is limited to exact models within series listed above
- Program is limited to exact textile patterns listed and exact colorways carded
- Orders cannot be changed or cancelled after order acknowledgment

- Current Global list pricing applies at the time of order
- All eligible models are UPSable; Global reserves the right to ship "best way"
- Bakhita, Popcorn, Duet and Sonic models may be multiple packaged and shipped "best way"
- Orders must be clean with correct model numbers, options, textiles, correct pricing, etc., to apply
- Dealer must be in good standing and within terms for order to be processed without delay
- Program available in the 48 contiguous United States
- Orders to ship outside Global's distribution model; order shipment



























- address can be to the dealer or end-user directly
- Standard model options listed under Optional Features section in the price list are available. Standard model options include aluminum bases, painted frame finishes, ballistic nylon backs, glide options and hard surface casters. Memory Foam as a standard option is not available (standard lead-times apply).

# 2 DAY LIGHTNING QUICKSHIP PROGRAM

Series	Model Numbers	Series	Model Numbers	Series	Model Numbers	Series	Model Numbers
<b>Duet</b> <i>(maximum 100)</i>	6620 6620-1 6621 6621-1 6621-2 6624	<b>Graphic</b> <i>(maximum 50)</i>	2736MB 2737 2738 2738MB 2739	<b>Sonic</b> <i>(maximum 100)</i>	6508 6508-1 6508MB 6508MB-1 6509 6509-1 6509MB 6509MB-1 6511 6511-1 6513 6513-1 6513MB 6513MB-1 6514 6514-1 6514MB 6514MB-1 6515 6515-1 6517WS	<b>Vion (Black Frame)</b> <i>(maximum 50)</i>	6321-0 6321-3 6321-4 6321-8 6322-0 6322-3 6322-4 6322-8 6324 6325 6324C 6325C 6327-6 6328-6 6331-0 6331-3 6331-4 6331-8 6332-0 6332-3 6332-4 6332-4 6335 TS6321-3
	5 Plastic Colors: Cloud (IVC) Latte (LAB) Night (BLK) Scarlet (SAR) Shadow (SHW)		Black Mesh only				
<b>Factor</b> <i>(maximum 50)</i>	5540-8 5541-8	<b>Loover</b> <i>(maximum 50)</i>	2661-0 2661-3 2661-4 2661-8 2662-0 2662-3 2662-4 2662-8	<b>Spritz Nester</b> <i>(maximum 50)</i>	6764C 6765C	<b>Vion (Fog Frame)</b> <i>(maximum 50)</i>	6321-0FG 6321-3FG 6321-4FG 6321-8FG 6322-0FG 6322-3FG 6322-4FG 6322-8FG 6324FG 6325FG 6324CFG 6325CFG 6327-6FG 6328-6FG 6331-0FG 6331-3FG 6331-4FG 6331-8FG 6332-0FG 6332-3FG 6332-4FG 6332-4FG 6335FG S6321-3FG
	1 Frame Finish: Black (BK)		5 Vue Mesh colors: Coal Black (VU19) Desert Sand (VU11) Quarry Grey (VU15) Sandy Beach (VU10) Tidal Wave (VU16)		Black Mesh only		5 Vion Mesh colors: Black (MS69) Blue (MS72) Natural (MS74) Stone (MS71) Rope (MS73)
<b>Global Accord</b> <i>(maximum 50)</i>	2670-2 2670LM-2 2670-4 2670LM-4 2671-2 2671LM-2 2671-4 2671LM-4 2672-6 2672LM-6	<b>Novello</b> <i>(maximum 50)</i>	6400 6401 6410 6411	<b>Supra</b> <i>(maximum 50)</i>	5330-4 5 5330L-4 5 5331-4 5 5331L-4 5		
			Black Shell / Arm/ Armcap only		Black Mesh only		
<b>Global Accord Mesh</b> <i>(maximum 50)</i>	2676-2 2676LM-2 2676-4 2676LM-4 2677-2 2677LM-2 2677-4 2677LM-4 2678-6 2678LM-6	<b>Popcorn</b> <i>(maximum 100)</i>	6710 6710-1 6710-2 6711 6711-1 6711-2 6715 6716 Clear Glides (set of 2)	<b>Supra X</b> <i>(maximum 50)</i>	5333-3 5336-1 5336-3 5337-6 5338-6 5339-6		
	5 Vue Mesh colors: Coal Black (VU19) Desert Sand (VU11) Quarry Grey (VU15) Sandy Beach (VU10) Tidal Wave (VU16)		5 Plastic Colors: Cloud (IVC) Latte (LAB) Night (BLK) Scarlet (SAR) Shadow (SHW)				
<b>Goal</b> <i>(maximum 50)</i>	2235-6 2236-6 2237-3 2237-5 2237-6 2239-6	<b>Roma</b> <i>(maximum 50)</i>	1901 1906 1906RA	<b>Synopsis</b> <i>(maximum 50)</i>	5080-0 5080-3 5081-0 5081-3 5090-4 5091-4		
			Black Mesh only				
<b>Graham</b> <i>(maximum 50)</i>	3144	<b>Roma Nester</b> <i>(maximum 50)</i>	1890 1899	<b>Triumph</b> <i>(maximum 50)</i>	3650-3 3650-8 3651-3 3651-8		
			Black Mesh only				
<b>Granada Deluxe</b> <i>(maximum 50)</i>	1170-3 1171-3 TS1170-3 TS1171-3	<b>Sidero</b> <i>(maximum 50)</i>	2125WS (chair dolly) 6900 6900C 6901 6901C	<b>Truform</b> <i>(maximum 50)</i>	5450-0 5450-3 5450-4 5450-8 5451-0 5451-3 5451-4 5451-8 5457-6 5458-6 S5457-6 S5458-6 TS5450-3 TS5451-3		
							
						<b>Weev</b> <i>(maximum 50)</i>	2220-3 2220-4 2220-8 2221-3 2221-4 2221-8
							Black Mesh only

• All product series have MAXIMUM order quantities which can be fulfilled within the 2 Day Lightning program. These are noted next to each series. For greater quantities, please contact CustomerCare for lead times and terms.

















# work + task

 Alero .....22	 G1 Ergo Select .....41	 Luray .....66
 Arno .....27	 G20 .....43	 Malaga .....68
 Arturo .....28	 Global Accord .....44	 Max .....69
 Aspen .....29	 Goal .....47	 Mirage .....70
 Auburn .....31	 Graham .....49	 Moda Task .....73
 Concorde .....32	 Granada .....50	 Novello .....71
 Diplomat .....34	 Granada Deluxe .....55	 ObusForme Comfort + XL .....74
 Enterprise .....35	 Graphic .....59	 Prefer .....80
 Factor .....39	 Loover .....62	 Priority .....82





# work + task

 Roma .....84	 Synopsis .....105
 Softcurve .....88	 Tamiri .....108
 Solar .....92	 Traditional .....111
 Solo .....94	 Triumph .....115
 Sora .....96	 Truform .....116
 Spritz .....98	 Tye .....119
 Supra .....100	 VionVion .....122
 Supra X .....102	 Weev .....129

ALERO™



model 1966-4



model 1960-3



**Headrest**  
Height/angle adjustable for user's individual needs. Increase back height up to 3". Standard on Extended back models Only.



model 1961-4



model 1962

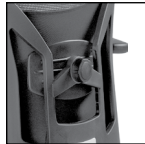

**Lumbar Support**  
Ability to be moved up and down to fit the lumbar region. Adjust in and out by turning the knob located on the back.

STANDARD FEATURES

- A skeletal style chair offers a unique look for today's office environment.
- Durable frame is constructed of fiberglass nylon.
- Standard adjustable height, forward swept arms with "sliding armcaps" (GL), (except model 1962 which has a fixed height arm same style).
- Height and depth adjustable lumbar support.
- Vari Width Adapter Plate (WA) Available when chair is ordered with adjustable height arms. Allows each arm to move outward an additional 2" (for a total of 4" extra seat width) and locks with the use of an easy to maneuver lever. Add \$62
- \*High back models ONLY. Back height can be adjusted by moving the headrest up and down.
- The seat and headrest can be upholstered in fabric, vinyl, leather or leather/ mock leather combination. Not available in Crescent fabric.
- Mesh back is available in Black only.
- All models are standard with a Black, urethane arched base. Base and frame are standard in Black (BK) with C1 casters.

OPTIONAL FEATURES

- Models 1962 and 1963 can be ordered without lumbar support if preferred Specify **BNL**. List price will remain as shown.
- New models featuring an upholstered back cushion are available.
- Available in fabric and leather/mock leather with the EXCEPTION of Jenny and textiles.
- For availability of chair series in Vinyl, please contact a Global Sales Representative.
- Optional Arched aluminum base available. Specify "**B5**". Add \$121.
- Please refer to "Arms Selection" section of the price book for arm options
- Please refer to the "Casters Selection" section of the price book for caster options. Optional casters may be priced higher than the standard casters for your chair and the difference will be charged. Lower priced optional casters will not be credited.
- For hard surface flooring casters, please specify **C9R**. Add \$49.
- For fully assembled in box, please specify **SU**. Add \$55.

DESCRIPTION FEATURES MODEL# STANDARD TEXTILE GRADES



**HB Knee - Tilter w/ Adjustable Headrest**  
COM Yardage: 1  
Freight Class: 150  
Product Weight (lbs.): 48  
Cubic Feet Per Carton: 9.75

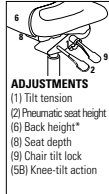

Ergonomic Features:  
A, B, C, D, E, H, J, M, N, V,

MODEL#	1	2	3	4	5	6	7	8	9	10	11	12
1960-2	943	970	988	1018	1059	1083	1122	1179	1232	1279	1397	1516

OVERALL DIMENSIONS			SEAT DIMENSIONS			BACK DIMENSIONS	
W	D	H	W	D	H	W	H
25	24.5	48	19.5	18-19.5	16-21	18	29.5



**HB Multi - Tilter w/ Adjustable Headrest**  
COM Yardage: 1  
Freight Class: 150  
Product Weight (lbs.): 46  
Cubic Feet Per Carton: 9.75

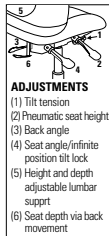

Ergonomic Features:  
A, B, C, D, E, G, H, M, N, S, V

MODEL#	1	2	3	4	5	6	7	8	9	10	11	12
1960-3	829	853	876	904	946	971	1007	1064	1119	1164	1282	1400

OVERALL DIMENSIONS			SEAT DIMENSIONS			BACK DIMENSIONS	
W	D	H	W	D	H	W	H
25	24.5	48.5	19.5	18-19.5	16.5-20.5	18	29.5



**HB Tilter w/ Adjustable Headrest**  
COM Yardage: 1  
Freight Class: 150  
Product Weight (lbs.): 44  
Cubic Feet Per Carton: 9.75

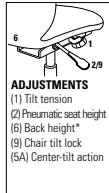

Ergonomic Features:  
A, B, C, D, E, H, M, N, S, V

MODEL#	1	2	3	4	5	6	7	8	9	10	11	12
1960-4	748	774	795	823	865	890	927	986	1037	1083	1201	1319

OVERALL DIMENSIONS			SEAT DIMENSIONS			BACK DIMENSIONS	
W	D	H	W	D	H	W	H
25	24.5	48.5	19.5	18-19.5	16.5-20.5	18	29.5



**DESCRIPTION**                      **FEATURES**                      **MODEL#**                      **STANDARD TEXTILE GRADES**



**MB Knee - Tilter**  
COM Yardage: 1  
Freight Class: 150  
Product Weight (lbs.): 44  
Cubic Feet Per Carton: 9.75

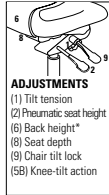

Ergonomic Features:  
A, B, C, D, E, H, J, M, N, V

MODEL#	1	2	3	4	5	6	7	8	9	10	11	12
1961-2	899	923	943	973	1016	1038	1078	1135	1188	1232	1352	1469

OVERALL DIMENSIONS			SEAT DIMENSIONS			BACK DIMENSIONS	
W	D	H	W	D	H	W	H
25	24.5	40	19.5	18-19.5	16-20	18	22.5



**MB Multi - Tilter**  
COM Yardage: 1  
Freight Class: 150  
Product Weight (lbs.): 44  
Cubic Feet Per Carton: 9.75

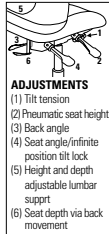

Ergonomic Features:  
A, B, C, D, E, G, H, M, N, S, V

MODEL#	1	2	3	4	5	6	7	8	9	10	11	12
1961-3	784	807	829	857	900	923	963	1019	1073	1119	1234	1354

OVERALL DIMENSIONS			SEAT DIMENSIONS			BACK DIMENSIONS	
W	D	H	W	D	H	W	H
25	24.5	40.5	19.5	18-19.5	16.5-20.5	18	22.5



**MB Tilter**  
COM Yardage: 1  
Freight Class: 150  
Product Weight (lbs.): 42  
Cubic Feet Per Carton: 9.75

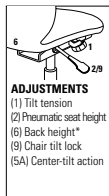

Ergonomic Features:  
A, B, C, D, E, H, M, N, S, V

MODEL#	1	2	3	4	5	6	7	8	9	10	11	12
1961-4	702	728	746	776	819	845	881	939	992	1037	1155	1276

OVERALL DIMENSIONS			SEAT DIMENSIONS			BACK DIMENSIONS	
W	D	H	W	D	H	W	H
25	24.5	40.5	19.5	18-19.5	16.5-20.5	18	22.5



**MB Operator w/ Arms**  
COM Yardage: 1  
Freight Class: 150  
Product Weight (lbs.): 40  
Cubic Feet Per Carton: 7.50

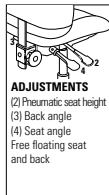

Ergonomic Features:  
C, D, E, F, G, H, M, N, S, V

MODEL#	1	2	3	4	5	6	7	8	9	10	11	12
1961-5	769	795	815	845	884	909	949	1004	1058	1104	1223	1339

OVERALL DIMENSIONS			SEAT DIMENSIONS			BACK DIMENSIONS	
W	D	H	W	D	H	W	H
25	24.5	40.5	19.5	18-19.5	16.5-20.5	18	22.5



**MB Task w/ Arms**  
COM Yardage: 1  
Freight Class: 150  
Product Weight (lbs.): 40  
Cubic Feet Per Carton: 7.50

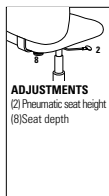



Ergonomic Features:  
C, D, E, H, M, N, V



MODEL#	1	2	3	4	5	6	7	8	9	10	11	12
1961-6	684	710	731	760	801	826	865	921	974	1021	1139	1256

OVERALL DIMENSIONS			SEAT DIMENSIONS			BACK DIMENSIONS	
W	D	H	W	D	H	W	H
25	24.5	41	19.5	18-19.5	17-22	18	22.5

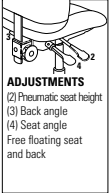



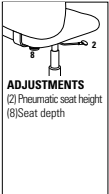









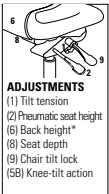

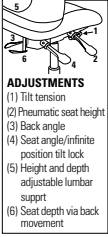

DESCRIPTION	FEATURES	MODEL#	STANDARD TEXTILE GRADES											
			1	2	3	4	5	6	7	8	9	10	11	12
 <p><b>MB Operator</b> Armless COM Yardage: 1 Freight Class: 150 Product Weight (lbs.): 32 Cubic Feet Per Carton: 7.50</p>	 <p><b>ADJUSTMENTS</b> (2) Pneumatic seat height (3) Back angle (4) Seat angle Free floating seat and back.</p>	1964-5	662	685	706	736	777	801	841	897	951	997	1114	1231
			<b>OVERALL DIMENSIONS</b>			<b>SEAT DIMENSIONS</b>			<b>BACK DIMENSIONS</b>					
			<b>W</b>	<b>D</b>	<b>H</b>	<b>W</b>	<b>D</b>	<b>H</b>	<b>W</b>		<b>H</b>			
			19.5	24.5	40.5	19.5	18-19.5	16.5-20.5	18		22.5			
			Ergonomic Features: C, D, E, F, G, M, N, V											
			<div style="display: flex; align-items: center; gap: 10px;"> <span style="border: 1px solid black; padding: 2px;">RTA 2</span>  </div>											

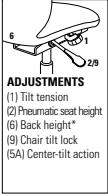

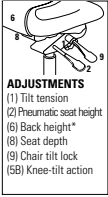

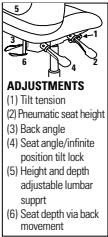

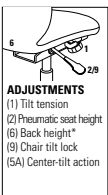

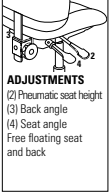

DESCRIPTION	FEATURES	MODEL#	STANDARD TEXTILE GRADES											
			1	2	3	4	5	6	7	8	9	10	11	12
 <p><b>MB Task</b> Armless COM Yardage: 1 Freight Class: 150 Product Weight (lbs.): 32 Cubic Feet Per Carton: 7.50</p>	 <p><b>ADJUSTMENTS</b> (2) Pneumatic seat height (8) Seat depth</p>	1964-6	574	600	621	650	692	716	755	812	865	910	1028	1147
			<b>OVERALL DIMENSIONS</b>			<b>SEAT DIMENSIONS</b>			<b>BACK DIMENSIONS</b>					
			<b>W</b>	<b>D</b>	<b>H</b>	<b>W</b>	<b>D</b>	<b>H</b>	<b>W</b>		<b>H</b>			
			19.5	24.5	41	19.5	18-19.5	17-22	18		22.5			
			Ergonomic Features: C, D, E, M, N, V											
			<div style="display: flex; align-items: center; gap: 10px;"> <span style="border: 1px solid black; padding: 2px;">RTA 2</span>  </div>											

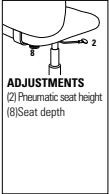

DESCRIPTION	FEATURES	MODEL#	STANDARD TEXTILE GRADES											
			1	2	3	4	5	6	7	8	9	10	11	12
 <p><b>Armchair w/ Arms</b> COM Yardage: 1 Freight Class: 250 Product Weight (lbs.): 40 Cubic Feet Per Carton: 13</p>	<p>Ergonomic Features: M, N, V</p>	1962	605	631	651	680	723	746	786	844	897	942	1059	1178
			<b>OVERALL DIMENSIONS</b>			<b>SEAT DIMENSIONS</b>			<b>BACK DIMENSIONS</b>					
			<b>W</b>	<b>D</b>	<b>H</b>	<b>W</b>	<b>D</b>	<b>H</b>	<b>W</b>		<b>H</b>			
			25	24.5	40	19.5	19	17.5	18		22.5			
			<div style="display: flex; align-items: center; gap: 10px;"> <span style="border: 1px solid black; padding: 2px;">RTA 2</span> </div>											

DESCRIPTION	FEATURES	MODEL#	STANDARD TEXTILE GRADES											
			1	2	3	4	5	6	7	8	9	10	11	12
 <p><b>MB Side Chair</b> Armless COM Yardage: 1 Freight Class: 150 Product Weight (lbs.): 33 Cubic Feet Per Carton: 8.25</p>	<p>Ergonomic Features: M, N, V</p>	1963	511	536	556	587	625	650	689	744	799	846	963	1080
			<b>OVERALL DIMENSIONS</b>			<b>SEAT DIMENSIONS</b>			<b>BACK DIMENSIONS</b>					
			<b>W</b>	<b>D</b>	<b>H</b>	<b>W</b>	<b>D</b>	<b>H</b>	<b>W</b>		<b>H</b>			
			19.5	24.5	40	19.5	19	17.5	18		22.5			
			<div style="display: flex; align-items: center; gap: 10px;"> <span style="border: 1px solid black; padding: 2px;">RTA 2</span>  </div>											

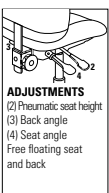
DESCRIPTION	FEATURES	MODEL#	STANDARD TEXTILE GRADES											
			1	2	3	4	5	6	7	8	9	10	11	12
 <p><b>HB Knee-Tilter</b> Upholstered Back w/ Adjustable Headrest COM Yardage: 2 Freight Class: 150 Product Weight (lbs.): 48 Cubic Feet Per Carton: 9.75</p>	 <p><b>ADJUSTMENTS</b> (1) Tilt tension (2) Pneumatic seat height (6) Back height* (8) Seat depth (9) Chair tilt lock (5B) Knee-tilt action</p>	1966-2	1118	1172	1214	1279	1369	1401	1482	1634	1707	1849	2041	2280
			<b>OVERALL DIMENSIONS</b>			<b>SEAT DIMENSIONS</b>			<b>BACK DIMENSIONS</b>					
			<b>W</b>	<b>D</b>	<b>H</b>	<b>W</b>	<b>D</b>	<b>H</b>	<b>W</b>		<b>H</b>			
			25	24.5	48	19.5	18-19.5	16-20	18		29.5			
			Ergonomic Features: A, B, C, D, E, H, J, M, N, V											
			<div style="display: flex; align-items: center; gap: 10px;"> <span style="border: 1px solid black; padding: 2px;">RTA 2</span>  </div>											

DESCRIPTION	FEATURES	MODEL#	STANDARD TEXTILE GRADES											
 <p><b>HB Multi - Tilter</b> Upholsterd Back w/ Adjustable Headrest COM Yardage: 2 Freight Class: 150 Product Weight (lbs.): 46 Cubic Feet Per Carton: 9.75</p>	 <p><b>ADJUSTMENTS</b> (1) Tilt tension (2) Pneumatic seat height (3) Back angle (4) Seat angle/infinite position tilt lock (5) Height and depth adjustable lumbar support (6) Seat depth via back movement</p>	<b>1966-3</b>	952	1006	1049	1114	1205	1236	1317	1469	1543	1685	1876	2115
		<b>OVERALL DIMENSIONS</b>			<b>SEAT DIMENSIONS</b>			<b>BACK DIMENSIONS</b>						
		<b>W</b>	<b>D</b>	<b>H</b>	<b>W</b>	<b>D</b>	<b>H</b>	<b>W</b>	<b>H</b>					
	25	24.5	48.5	19.5	18-19.5	16.5-20.5	18	29.5						
				<b>RTA 2</b>										
 <p><b>HB Tilter</b> Upholsterd Back w/ Adjustable Headrest COM Yardage: 2 Freight Class: 150 Product Weight (lbs.): 44 Cubic Feet Per Carton: 9.75</p>	 <p><b>ADJUSTMENTS</b> (1) Tilt tension (2) Pneumatic seat height (6) Back height* (9) Chair tilt lock (5A) Center-tilt action</p>	<b>1966-4</b>	873	926	971	1034	1124	1157	1236	1389	1463	1605	1796	2035
		<b>OVERALL DIMENSIONS</b>			<b>SEAT DIMENSIONS</b>			<b>BACK DIMENSIONS</b>						
		<b>W</b>	<b>D</b>	<b>H</b>	<b>W</b>	<b>D</b>	<b>H</b>	<b>W</b>	<b>H</b>					
	25	24.5	48.5	19.5	18-19.5	16.5-20.5	18	29.5						
				<b>RTA 2</b>										
 <p><b>MB Knee - Tilter</b> Upholsterd Back COM Yardage: 9.75 Freight Class: 150 Product Weight (lbs.): 44 Cubic Feet Per Carton: 9.75</p>	 <p><b>ADJUSTMENTS</b> (1) Tilt tension (2) Pneumatic seat height (6) Back height* (8) Seat depth (9) Chair tilt lock (5B) Knee-tilt action</p>	<b>1967-2</b>	1069	1123	1166	1230	1322	1354	1432	1586	1660	1800	1994	2231
		<b>OVERALL DIMENSIONS</b>			<b>SEAT DIMENSIONS</b>			<b>BACK DIMENSIONS</b>						
		<b>W</b>	<b>D</b>	<b>H</b>	<b>W</b>	<b>D</b>	<b>H</b>	<b>W</b>	<b>H</b>					
	25	24.5	40	19.5	18-19.5	16-20	18	22.5						
				<b>RTA 2</b>										
 <p><b>MB Multi - Tilter</b> Upholsterd Back COM Yardage: 2 Freight Class: 150 Product Weight (lbs.): 44 Cubic Feet Per Carton: 13</p>	 <p><b>ADJUSTMENTS</b> (1) Tilt tension (2) Pneumatic seat height (3) Back angle (4) Seat angle/infinite position tilt lock (5) Height and depth adjustable lumbar support (6) Seat depth via back movement</p>	<b>1967-3</b>	904	957	1001	1066	1156	1189	1268	1423	1495	1636	1829	2068
		<b>OVERALL DIMENSIONS</b>			<b>SEAT DIMENSIONS</b>			<b>BACK DIMENSIONS</b>						
		<b>W</b>	<b>D</b>	<b>H</b>	<b>W</b>	<b>D</b>	<b>H</b>	<b>W</b>	<b>H</b>					
	25	24.5	40.5	19.5	18-19.5	16.5-20.5	18	22.5						
				<b>RTA 2</b>										
 <p><b>MB Tilter</b> Upholsterd Back COM Yardage: 2 Freight Class: 150 Product Weight (lbs.): 42 Cubic Feet Per Carton: 9.75</p>	 <p><b>ADJUSTMENTS</b> (1) Tilt tension (2) Pneumatic seat height (6) Back height* (9) Chair tilt lock (5A) Center-tilt action</p>	<b>1967-4</b>	857	912	954	1019	1109	1142	1223	1375	1449	1591	1781	2020
		<b>OVERALL DIMENSIONS</b>			<b>SEAT DIMENSIONS</b>			<b>BACK DIMENSIONS</b>						
		<b>W</b>	<b>D</b>	<b>H</b>	<b>W</b>	<b>D</b>	<b>H</b>	<b>W</b>	<b>H</b>					
	25	24.5	40.5	19.5	18-19.5	16.5-20.5	18	22.5						
				<b>RTA 2</b>										

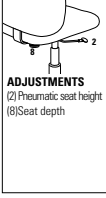
DESCRIPTION	FEATURES	MODEL#	STANDARD TEXTILE GRADES																																				
			1	2	3	4	5	6	7	8	9	10	11	12																									
 <p><b>MB Operator</b> Upholstered Back w/ Arms COM Yardage: 2 Freight Class: 150 Product Weight (lbs.): 40 Cubic Feet Per Carton: 9.75</p>	 <p><b>ADJUSTMENTS</b> (2) Pneumatic seat height (3) Back angle (4) Seat angle Free floating seat and back</p>	<p>Ergonomic Features: C, D, E, F, G, H, M, N, V</p>	<table border="1"> <tr> <th colspan="3">OVERALL DIMENSIONS</th> <th colspan="3">SEAT DIMENSIONS</th> <th colspan="3">BACK DIMENSIONS</th> </tr> <tr> <th>W</th> <th>D</th> <th>H</th> <th>W</th> <th>D</th> <th>H</th> <th>W</th> <th>H</th> </tr> <tr> <td>25</td> <td>24.5</td> <td>40.5</td> <td>19.5</td> <td>18-19.5</td> <td>16.5-20.5</td> <td>18</td> <td>22.5</td> </tr> </table>												OVERALL DIMENSIONS			SEAT DIMENSIONS			BACK DIMENSIONS			W	D	H	W	D	H	W	H	25	24.5	40.5	19.5	18-19.5	16.5-20.5	18	22.5
			OVERALL DIMENSIONS			SEAT DIMENSIONS			BACK DIMENSIONS																														
			W	D	H	W	D	H	W	H																													
			25	24.5	40.5	19.5	18-19.5	16.5-20.5	18	22.5																													
<p>RTA 2 </p>																																							
 <p><b>MB Task</b> Upholstered Back w/ Arms COM Yardage: 2 Freight Class: 150 Product Weight (lbs.): 40 Cubic Feet Per Carton: 7.50</p>	 <p><b>ADJUSTMENTS</b> (2) Pneumatic seat height (8) Seat depth</p>	<p>Ergonomic Features: C, D, E, F, G, H, M, N, V</p>	<table border="1"> <tr> <th colspan="3">OVERALL DIMENSIONS</th> <th colspan="3">SEAT DIMENSIONS</th> <th colspan="3">BACK DIMENSIONS</th> </tr> <tr> <th>W</th> <th>D</th> <th>H</th> <th>W</th> <th>D</th> <th>H</th> <th>W</th> <th>H</th> </tr> <tr> <td>25</td> <td>24.5</td> <td>41</td> <td>21</td> <td>18</td> <td>17.5-21.5</td> <td>21</td> <td>31</td> </tr> </table>												OVERALL DIMENSIONS			SEAT DIMENSIONS			BACK DIMENSIONS			W	D	H	W	D	H	W	H	25	24.5	41	21	18	17.5-21.5	21	31
			OVERALL DIMENSIONS			SEAT DIMENSIONS			BACK DIMENSIONS																														
			W	D	H	W	D	H	W	H																													
			25	24.5	41	21	18	17.5-21.5	21	31																													
<p>RTA 2 </p>																																							
 <p><b>MB Armchair</b> Upholstered Back w/ Arms COM Yardage: 2 Freight Class: 250 Product Weight (lbs.): 40 Cubic Feet Per Carton: 13</p>	<p>Ergonomic Features: M, N, V</p>	<table border="1"> <tr> <th colspan="3">OVERALL DIMENSIONS</th> <th colspan="3">SEAT DIMENSIONS</th> <th colspan="3">BACK DIMENSIONS</th> </tr> <tr> <th>W</th> <th>D</th> <th>H</th> <th>W</th> <th>D</th> <th>H</th> <th>W</th> <th>H</th> </tr> <tr> <td>25</td> <td>24.5</td> <td>40</td> <td>19.5</td> <td>18-19.5</td> <td>17.5</td> <td>18</td> <td>22.5</td> </tr> </table>												OVERALL DIMENSIONS			SEAT DIMENSIONS			BACK DIMENSIONS			W	D	H	W	D	H	W	H	25	24.5	40	19.5	18-19.5	17.5	18	22.5	
		OVERALL DIMENSIONS			SEAT DIMENSIONS			BACK DIMENSIONS																															
		W	D	H	W	D	H	W	H																														
		25	24.5	40	19.5	18-19.5	17.5	18	22.5																														
<p>RTA 2</p>																																							
 <p><b>MB Chair</b> Upholstered Back Armless COM Yardage: 2 Freight Class: 150 Product Weight (lbs.): 33 Cubic Feet Per Carton: 8.25</p>	<p>Ergonomic Features: M, N, V</p>	<table border="1"> <tr> <th colspan="3">OVERALL DIMENSIONS</th> <th colspan="3">SEAT DIMENSIONS</th> <th colspan="3">BACK DIMENSIONS</th> </tr> <tr> <th>W</th> <th>D</th> <th>H</th> <th>W</th> <th>D</th> <th>H</th> <th>W</th> <th>H</th> </tr> <tr> <td>19.5</td> <td>24.5</td> <td>40</td> <td>19.5</td> <td>18-19.5</td> <td>17.5</td> <td>18</td> <td>22.5</td> </tr> </table>												OVERALL DIMENSIONS			SEAT DIMENSIONS			BACK DIMENSIONS			W	D	H	W	D	H	W	H	19.5	24.5	40	19.5	18-19.5	17.5	18	22.5	
		OVERALL DIMENSIONS			SEAT DIMENSIONS			BACK DIMENSIONS																															
		W	D	H	W	D	H	W	H																														
		19.5	24.5	40	19.5	18-19.5	17.5	18	22.5																														
<p>RTA 2 </p>																																							
 <p><b>MB Operator</b> Upholstered Back Armless COM Yardage: 2 Freight Class: 150 Product Weight (lbs.): 32 Cubic Feet Per Carton: 7.50</p>	 <p><b>ADJUSTMENTS</b> (2) Pneumatic seat height (3) Back angle (4) Seat angle Free floating seat and back</p>	<p>Ergonomic Features: C, D, E, F, G, M, N, V</p>	<table border="1"> <tr> <th colspan="3">OVERALL DIMENSIONS</th> <th colspan="3">SEAT DIMENSIONS</th> <th colspan="3">BACK DIMENSIONS</th> </tr> <tr> <th>W</th> <th>D</th> <th>H</th> <th>W</th> <th>D</th> <th>H</th> <th>W</th> <th>H</th> </tr> <tr> <td>19.5</td> <td>24.5</td> <td>40.5</td> <td>19.5</td> <td>18-19.5</td> <td>16.5-20.5</td> <td>18</td> <td>22.5</td> </tr> </table>												OVERALL DIMENSIONS			SEAT DIMENSIONS			BACK DIMENSIONS			W	D	H	W	D	H	W	H	19.5	24.5	40.5	19.5	18-19.5	16.5-20.5	18	22.5
			OVERALL DIMENSIONS			SEAT DIMENSIONS			BACK DIMENSIONS																														
			W	D	H	W	D	H	W	H																													
			19.5	24.5	40.5	19.5	18-19.5	16.5-20.5	18	22.5																													
<p>RTA 2 </p>																																							

DESCRIPTION	FEATURES	MODEL#	STANDARD TEXTILE GRADES											
			1	2	3	4	5	6	7	8	9	10	11	12
 <p><b>MB Task</b> Upholstered Back Armless COM Yardage: 2 Freight Class: 150 Product Weight (lbs.): 32 Cubic Feet Per Carton: 7.50</p>	 <p><b>ADJUSTMENTS</b> (2) Pneumatic seat height (8) Seat depth</p>	<p><b>1969-6</b></p>	695	749	792	854	946	979	1059	1212	1285	1427	1619	1857
			<p><b>OVERALL DIMENSIONS SEAT DIMENSIONS BACK DIMENSIONS</b></p>			W	D	H	W	D	H	W	H	
			19.5	24.5	41	19.5	18-19.5	17-22	18					
	<p>Ergonomic Features: C, D, E, M, N, V</p>	<p><b>RTA 2</b></p> 												

DESCRIPTION	FEATURES	MODEL#	STANDARD TEXTILE GRADES											
			1	2	3	4	5	6	7	8	9	10	11	12
 <p><b>model 4003</b></p>	<p><b>ADJUSTMENTS</b> (1) Tilt tension (2) Pneumatic seat height (8) Chair tilt lock (5A) Center-tilt action</p>	<p><b>4003</b></p>	-	-	-	-	396	-	-	723	823	987	1231	1525
			<p><b>OVERALL DIMENSIONS SEAT DIMENSIONS BACK DIMENSIONS</b></p>			W	D	H	W	D	H	W	H	
			25	29	42	20.5	19	16-20	21	24				
	<p>Ergonomic Features: A, B, C, N, S</p>	<p><b>RTA 1</b></p>	<p><b>STANDARD FEATURES</b></p> <ul style="list-style-type: none"> <li>Perforated leather inserts in the seat and back surfaces.</li> <li>Standard Black (BK) molded flared loop arms and a five-legged injection molded base with C65 casters.</li> <li>Model 4003-SC features a self centering cylinder which swivels and automatically returns to the starting seat location. Standard with a flat 5 star base in Black (BK) with C7 glides.</li> <li>Standard in Leather/Mock Leather combination (Grade 5). Not available in Fabric.</li> </ul> <p><b>OPTIONAL FEATURES</b></p> <ul style="list-style-type: none"> <li>Please refer to the "Casters Selection" section of the price book for caster options. Optional casters may be priced higher than the standard casters for your chair and the difference will be charged. Lower priced optional casters will not be credited.</li> <li>Optional ballistic nylon outer back fabric available. Resistant to impact damage, only in Black (BKB). Add \$14.</li> <li>For hard surface flooring casters, please specify C10R. Add \$85.</li> <li>For fully assembled in box, please specify SU. Add \$55.</li> </ul>											

DESCRIPTION	FEATURES	MODEL#	STANDARD TEXTILE GRADES											
			1	2	3	4	5	6	7	8	9	10	11	12
 <p><b>HB Tilter</b> COM Yardage: 2.50 Freight Class: 250 Product Weight (lbs.): 39 Cubic Feet Per Carton: 11.50</p>	<p><b>ADJUSTMENTS</b> (1) Tilt tension (2) Pneumatic seat height (8) Chair tilt lock (5A) Center-tilt action</p>	<p><b>4003-SC</b></p>	-	-	-	-	450	-	-	781	884	1050	1301	1600
			<p><b>OVERALL DIMENSIONS SEAT DIMENSIONS BACK DIMENSIONS</b></p>			W	D	H	W	D	H	W	H	
			25	29	44	20.5	18	18.5	21	24				
	<p>Ergonomic Features: A, B, C, N, S</p>	<p><b>RTA 1</b></p>	<p><b>HB Conference Chair</b> COM Yardage: 2.50 Freight Class: 250 Product Weight (lbs.): 39 Cubic Feet Per Carton: 11.50</p>											

DESCRIPTION	FEATURES	MODEL#	STANDARD TEXTILE GRADES											
			1	2	3	4	5	6	7	8	9	10	11	12
 <p><b>Armchair w/ Sled Base</b> COM Yardage: 2.50 Freight Class: 250 Product Weight (lbs.): 33 Cubic Feet Per Carton: 13</p>	<p><b>ADJUSTMENTS</b> (1) Tilt tension (2) Pneumatic seat height (8) Chair tilt lock (5A) Center-tilt action</p>	<p><b>4004</b></p>	-	-	-	-	396	-	-	723	823	987	1231	1525
			<p><b>OVERALL DIMENSIONS SEAT DIMENSIONS BACK DIMENSIONS</b></p>			W	D	H	W	D	H	W	H	
			24.5	26.5	36	20	19	18	20.5	19				
	<p>Ergonomic Features: N</p>	<p><b>RTA 1</b></p>	<p><b>HB Conference Chair</b> COM Yardage: 2.50 Freight Class: 250 Product Weight (lbs.): 39 Cubic Feet Per Carton: 11.50</p>											

**ARTURO™**



model 3991



model 3992

**STANDARD FEATURES**

- Stitched seat and back design, padded headrest (model 3991) and upholstered open arms.
- All models are standard with a five-legged, injection molded “spider” base.
- Base and frame are available in Black (BK) Only.
- C65 casters are standard.
- Standard in Leather/Mock Leather combination (Grade 5). Not available in Fabric.

**OPTIONAL FEATURES**

- For fully assembled in box, please specify **SU**. Add \$55

- Please refer to the “Casters Selection” section of the price book for caster options. Optional casters may be priced higher than the standard casters for your chair and the difference will be charged. Lower priced optional casters will not be credited.
- For hard surface flooring casters, specify **C65R**. Add \$51.
- For Memory Foam, specify **(MF)** and add \$84. Available on model 3991 only.
- Optional ballistic nylon outer back fabric available. Resistant to impact damage, only in Black (BKB). Add \$14.

DESCRIPTION	FEATURES	MODEL#	STANDARD TEXTILE GRADES											
-------------	----------	--------	-------------------------	--	--	--	--	--	--	--	--	--	--	--



**Extended HB Tilter**  
COM Yardage: 4  
Freight Class: 250  
Product Weight (lbs.): 54  
Cubic Feet Per Carton: 14

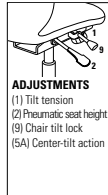

Ergonomic Features:  
A, B, C, M, N, S

	1	2	3	4	5	6	7	8	9	10	11	12
<b>3991</b>	-	-	-	-	1132	-	-	1652	1811	2072	2465	2936

OVERALL DIMENSIONS			SEAT DIMENSIONS			BACK DIMENSIONS	
W	D	H	W	D	H	W	H
26	30.5	50	21	20	16.5-20.5	21.5	30.5

**RTA 1**



**HB Tilter**  
COM Yardage: 3.50  
Freight Class: 250  
Product Weight (lbs.): 52  
Cubic Feet Per Carton: 13.25

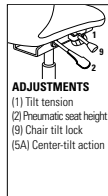

Ergonomic Features:  
A, B, C, M, N, S

	1	2	3	4	5	6	7	8	9	10	11	12
<b>3992</b>	-	-	-	-	1047	-	-	1501	1642	1869	2214	2627

OVERALL DIMENSIONS			SEAT DIMENSIONS			BACK DIMENSIONS	
W	D	H	W	D	H	W	H
26	30	43	20.5	19.5	16.5-20.5	20.5	25

**RTA 1**



**LB Tilter**  
COM Yardage: 3.50  
Freight Class: 250  
Product Weight (lbs.): 44  
Cubic Feet Per Carton: 11.50

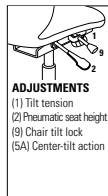

Ergonomic Features:  
A, B, C, M, N, S

	1	2	3	4	5	6	7	8	9	10	11	12
<b>3993</b>	-	-	-	-	1007	1080	1217	1463	1605	1833	2176	2587

OVERALL DIMENSIONS			SEAT DIMENSIONS			BACK DIMENSIONS	
W	D	H	W	D	H	W	H
26	29.5	37	20.5	19.5	16.5-20.5	20.5	18

**RTA 1**

ASPEN™



model 2850-3



model 2851-3



**Lumbar Support**  
Back height can be adjusted to enable a user to reposition the contact zone of lumbar support.



model 2852-3

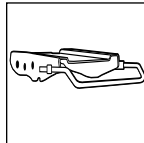

**Multi-Depth Mechanism**  
Standard on Multi-Tilter. Allows seat to move forward and backward over a 2" range with 5 locking positions to provide a more shallow or deeper seat.

STANDARD FEATURES

- Aspen features a slender design and sensitive profile with a superior level of comfort.
- Extended back models are standard with a height adjustable headrest.
- Ratchet back height adjustment.
- All models are standard with height and width adjustable arms (AS) that feature a sliding armcap providing extra support for all users.
- Models feature braille on the underside of all paddles.
- Model 2852-6SC features a self centering cylinder which swivels and automatically returns to the starting seat location. This model is standard with a flat 5 star base in Black (BK) with C7 glides.
- Base and arm detail is standard in Black (BK).
- All models are standard with seat depth adjustment.
- All models are shipped partially KD.
- C82 dual wheel carpet casters are standard.



- Multi-Depth Mechanism Standard on Multi-tilter models only. Allows seat to move forward and backward over a 2" range with 5 locking positions to provide a more shallow or deeper seat.

OPTIONAL FEATURES

- Optional polished aluminum base is available. Please specify (ALU). Add \$121. Coordinating chrome finished arms are available at no upcharge. Please specify (AC).
- Please refer to "Arm Selection" section of the price book for additional arm options.
- Please refer to "Cylinder Selection" section of the price book for additional cylinder options.
- For hard surface flooring casters, specify C9R. Add \$63.
- Available in fabrics, vinyls, and leathers with the EXCEPTION of Match. Also available in two tone upholstery as shown.
- For fully assembled in box, please specify SU. Add \$55.

DESCRIPTION FEATURES MODEL# STANDARD FABRIC GRADES



**Extended Back Multi - Tilter**  
COM Yardage: 2.50  
Freight Class: 150  
Product Weight (lbs.): 66  
Cubic Feet Per Carton: 14.75

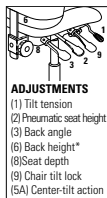

Ergonomic Features:  
A, B, C, D, E, F, G, H, M, N, Q, S, V

	1	2	3	4	5	6	7	8	9	10	11	12
<b>2850-3</b>	1124	1189	1241	1317	1425	1464	1559	1740	1828	1996	2224	2509
<b>2850LM-3</b>	-	-	-	-	1520	-	-	1835	1933	2090	2329	2615
Leather/Mock Leather												
OVERALL DIMENSIONS			SEAT DIMENSIONS			BACK DIMENSIONS						
W	D	H	W	D	H	W	H					
25	24	45	19.5	19.5-21	16.5-20.5	18.5	26.5-29					



**HB Multi - Tilter**  
COM Yardage: 2.25  
Freight Class: 150  
Product Weight (lbs.): 64  
Cubic Feet Per Carton: 14.75

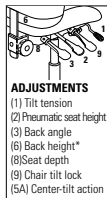

Ergonomic Features:  
A, B, C, D, E, F, G, H, M, N, Q, S, V

	1	2	3	4	5	6	7	8	9	10	11	12
<b>2851-3</b>	1004	1061	1107	1176	1274	1309	1394	1558	1635	1788	1993	2249
<b>2851LM-3</b>	-	-	-	-	1359	-	-	1554	1615	1712	1860	2035
Leather/ Mock Leather												
OVERALL DIMENSIONS			SEAT DIMENSIONS			BACK DIMENSIONS						
W	D	H	W	D	H	W	H					
25	24	41	19.5	18-19.5	16.5-20.5	19.5	22.5					



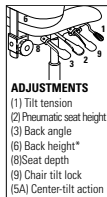

**MB Multi - Tilter**  
COM Yardage: 2  
Freight Class: 150  
Product Weight (lbs.): 62  
Cubic Feet Per Carton: 13



Ergonomic Features:  
A, B, C, D, E, F, G, H, M, N, Q, S, V

	1	2	3	4	5	6	7	8	9	10	11	12
<b>2852-3</b>	975	1026	1068	1128	1215	1247	1322	1467	1537	1671	1854	2083
<b>2852LM-3</b>	-	-	-	-	1296	-	-	1492	1553	1651	1797	1974
Leather/Mock Leather												
OVERALL DIMENSIONS			SEAT DIMENSIONS			BACK DIMENSIONS						
W	D	H	W	D	H	W	H					
25	24	37	19.5	18.5-21	16.5-20.5	18.5	18.5-21					



DESCRIPTION	FEATURES	MODEL#	STANDARD FABRIC GRADES												
			1	2	3	4	5	6	7	8	9	10	11	12	
 <p><b>MB Conference Chair</b>                      COM Yardage: 2                      Freight Class: 250                      Product Weight (lbs.): 44                      Cubic Feet Per Carton: 13</p>			<b>2852-6SC</b>	896	946	988	1049	1136	1167	1243	1388	1458	1592	1775	2004
			<b>2852LM-6SC</b>	-	-	-	-	1187	-	-	1452	1533	1666	1867	2105
			Leather/Mock Leather												
			OVERALL DIMENSIONS			SEAT DIMENSIONS			BACK DIMENSIONS						
			W	D	H	W	D	H	W	D	H				
			25	24	37	19.5	18.5	18.5	18.5	18.5	21				
			Ergonomic Features: A, B, D, H, M, N, Q, S			RTA 2									



AUBURN



model 3767



Wood-capped base



Polished Aluminum



**Optional Base**  
Polished Aluminum (ALU) finish is available on arm frame and base at an upcharge. Add \$272.



**Optional Base**  
Wood-capped steel base with C1 casters is available at an upcharge (B4M). Add \$333.

STANDARD FEATURES

- This transitional style judge's chair offers a scrolled urethane arm for durability and comfort.
- Standard with a five-legged, injection molded base in Black (BK) with C10 casters.
- Standard in Leather/Mock Leather combination (grade 5). Not available in Fabric.

OPTIONAL FEATURES

- Wood-capped base available in Absolute (AAM), Black (BKM), Cherry (ACM), Espresso Cafe (ECM), English Oak (EOM), Fruitwood (TFM), Gray (HGM), Honey (AHM), Mahogany (TMM), Maple (AVM), Medium Walnut (MWM), Night (ASM), Shaker Cherry (SKM), Walnut (TWM), WC Cream (WTM), White (WHM) and Winter Cherry (WCM). Please Specify. Genuine maple faced veneers and solids are used.

- Optional aluminum base is available. A B2 aluminum base with black scuff tips and C10 casters. Add \$121.
- For hard flooring surface casters with wood-capped base, please specify C9R. Add 12.
- For hard surface flooring please specify C10R casters.
- Please refer to the "Casters Selection" section of the price book for caster options. Optional casters may be priced higher than the standard casters for your chair and the difference will be charged. Lower priced optional casters will not be credited.
- For availability of chair series in Vinyl, please contact a Global Sales Representative.
- For fully assembled in box, please specify SU. Add \$55.

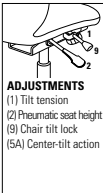
DESCRIPTION	FEATURES	MODEL#	STANDARD TEXTILE GRADES														
			1	2	3	4	5	6	7	8	9	10	11	12			
 <p><b>HB Tilter</b> COM Yardage: 3 Freight Class: 250 Product Weight (lbs.): 63 Cubic Feet Per Carton: 22.25</p>	 <p><b>ADJUSTMENTS</b> (1) Tilt tension (2) Pneumatic seat height (9) Chair tilt lock (5A) Center-tilt action</p>	<p><b>3767</b></p>	-	-	-	-	1282	-	-	1646	1760	1942	2218	2548			
			OVERALL DIMENSIONS			SEAT DIMENSIONS			BACK DIMENSIONS								
			W	D	H	W	D	H	W	H							
28	28	46.5	21.5	18	16.5-20.5	21.5	27.5										
		RTA 00															
Ergonomic Features: A, B, C, M, N, S																	

CONCORDE™



model 2400-18



model 2400-18



**Push Button**  
Location within reach increases your adjustment. Promotes good posture as you move to various positions.



model 2409



**Polished Aluminum Base**  
Concorde Presidential models are standard with a polished aluminum base.

STANDARD FEATURES

- All adjustments are made with easy-use button controls that are conveniently located in full view.
- Compound curved molded foam seat and back cushions.
- Standard with Allen-bolted width adjustable arms (Allen key included). Arms adjust 1.25" wider on each side for a total of 2.5" extra width.
- Push button controlled tilt lock and push button controlled seat height.
- Seat cushions are easily removed without tools for ease of cleaning.
- Five prong, injection molded, fiberglass reinforced nylon Black base with (C10) dual wheel carpet casters.
- Upholstery options: Brisa, Brisa Distressed, Match, Pure, Renewal, Silhouette, Ultraleather, Vital or any leather. Not available in Crescent, vinyl or leather/mock leather combination.
- Model 2424 is rated for multi-shift use for persons up to 350 pounds.
- For 24 hour application, Global's limited lifetime warranty is applicable only on fabrics that are rated for 100,000 double rubs.
- Concorde is fully assembled in box, as standard.

OPTIONAL FEATURES

- There are no arm options for this series.
- Optional aluminum base is available. Add. \$121.
- For hard surface flooring casters, please specify (C10R). Add \$47.
- For additional caster options, please refer to the Arm and Caster section. *Optional casters may be priced higher than the standard casters for your chair and the difference will be charged. Lower priced optional casters will not be credited.*

CONCORDE PRESIDENTIAL (MODEL #2409)

STANDARD FEATURES

- Only available in Leather.
- Has a larger headrest, wider back and closed upholstered arms.
- Features decorative stitching, standard in a heavy gauge off-white stitch detail to show contrast with leather upholstery.
- Features perforated leather inserts in the seat and back cushions.
- Standard with (C25) dual wheel carpet casters.
- Standard with a Polished Aluminum base.

OPTIONAL FEATURES

- Normal gauge color coordinated thread can be used upon request. Specify "matching thread" on order. No upcharge.
- Non-perforated leather inserts in the seat and back cushions are optional. Specify (NR).
- Optional with a Black base and Black arm button trim at no additional charge. Specify (BK).

DESCRIPTION

FEATURES

MODEL#

STANDARD TEXTILE GRADES



**HB Multi - Tilter** Concorde Executive  
COM Yardage: 2.50  
Freight Class: 250  
Product Weight (lbs.): 76  
Cubic Feet Per Carton: 23.50

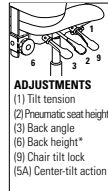

**ADJUSTMENTS**  
(1) Tilt tension  
(2) Pneumatic seat height  
(3) Back angle  
(6) Back height\*  
(9) Chair tilt lock  
(5A) Center-tilt action

Ergonomic Features:  
A, B, C, D, G, M, N, Q, S, T

	1	2	3	4	5	6	7	8	9	10	11	12
<b>2400-18</b>	-	3144	3196	3276	3389	3430	3529	3712	3803	3974	4214	4508

OVERALL DIMENSIONS			SEAT DIMENSIONS			BACK DIMENSIONS		
W	D	H	W	D	H	W	H	
26	28	48	21	19.5	17.5-21.5	21	31	

RTA 00



**HB Synchro - Tilter Deluxe** Concorde Presidential  
COM Yardage: 23.50  
Freight Class: 250  
Product Weight (lbs.): 78  
Cubic Feet Per Carton: 23.50

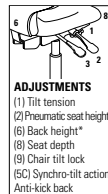



**ADJUSTMENTS**  
(1) Tilt tension  
(2) Pneumatic seat height  
(6) Back height\*  
(8) Seat depth  
(9) Chair tilt lock  
(5C) Synchro-tilt action  
Anti-kick back

Ergonomic Features:  
A, B, C, D, E, L, M, N, Q, T

	1	2	3	4	5	6	7	8	9	10	11	12
<b>2409</b>	-	-	-	-	-	-	-	-	-	5158	5544	5955

OVERALL DIMENSIONS			SEAT DIMENSIONS			BACK DIMENSIONS		
W	D	H	W	D	H	W	H	
28.5	27	50	21	18-20	18-22	21	28-31	

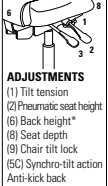
RTA 00

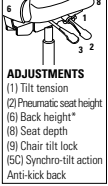
DESCRIPTION	FEATURES	MODEL#	STANDARD TEXTILE GRADES											
			1	2	3	4	5	6	7	8	9	10	11	12
 <p><b>HB Synchro - Tilter</b> Concorde Executive 24HR COM Yardage: 2.50 Freight Class: 250 Product Weight (lbs.): 78 Cubic Feet Per Carton: 23.50</p>	 <p><b>ADJUSTMENTS</b> (1) Tilt tension (2) Pneumatic seat height (6) Back height* (8) Seat depth (9) Chair tilt lock (5C) Synchro-tilt action Anti-kick back</p>	<p>2424</p>	-	2354	2407	2485	2599	2641	2737	2923	3013	3184	3421	3716
			<b>OVERALL DIMENSIONS</b>			<b>SEAT DIMENSIONS</b>			<b>BACK DIMENSIONS</b>					
			<b>W</b>	<b>D</b>	<b>H</b>	<b>W</b>	<b>D</b>	<b>H</b>	<b>W</b>	<b>H</b>				
			28.5	27	50	21	17.5-19	18-22	21	28-31				
			<b>RTA 00</b>											
 <p><b>HB Synchro - Tilter</b> Concorde Executive 24HR COM Yardage: 2.50 Freight Class: 250 Product Weight (lbs.): 78 Cubic Feet Per Carton: 23.50</p>	 <p><b>ADJUSTMENTS</b> (1) Tilt tension (2) Pneumatic seat height (6) Back height* (8) Seat depth (9) Chair tilt lock (5C) Synchro-tilt action Anti-kick back</p>	<p>2424-18</p>	-	2392	2448	2526	2635	2680	2778	2962	3054	3226	3464	3758
			<b>OVERALL DIMENSIONS</b>			<b>SEAT DIMENSIONS</b>			<b>BACK DIMENSIONS</b>					
			<b>W</b>	<b>D</b>	<b>H</b>	<b>W</b>	<b>D</b>	<b>H</b>	<b>W</b>	<b>H</b>				
			28.5	27	50	21	17.5-19	18-22	21	28-31				
			<b>RTA 00</b>											

DIPLOMAT



model 2106

model 2107

STANDARD FEATURES

- A contoured seat and back are accented by wood arms and base (on tilter models), providing comfort and classic styling.
- Series includes Tilters, guest chairs and bar stool. See page 178-179 for additional series
- **C1** casters are standard on tilter models.
- When upholstered in Leather or Leather Mock, models will be in all Leather or in all Leather Mock.

OPTIONAL FEATURES

- Wood-capped base and arms are available in Absolute (**AAM**), Black (**BKM**), Cherry (**ACM**), Espresso Cafe (**ECM**), English Oak (**EOM**), Fruitwood (**TFM**), Gray (**HGM**), Honey (**AHM**),

Mahogany (**TMM**), Maple (**AVM**), Medium Walnut (**MWM**), Night (**ASM**), Shaker Cherry (**SKM**), Walnut (**TWM**), WC Cream (**WTM**), White (**WHM**) and Winter Cherry (**WCM**). Please Specify. Genuine maple faced veneers and solids are used.

- Please refer to the "Casters Selection" section of the price book for caster options. Optional casters may be priced higher than the standard casters for your chair and the difference will be charged. Lower priced optional casters will not be credited.
- For fully assembled in box, please specify **SU**. Add \$55.

DESCRIPTION

FEATURES

MODEL#

STANDARD TEXTILE GRADES

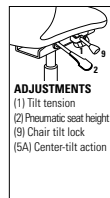

**HB Tilter**  
COM Yardage: 11.75  
Freight Class: 250  
Product Weight (lbs.): 40  
Cubic Feet Per Carton: 11.75

Ergonomic Features:  
A, B, C, M, N, S

	1	2	3	4	5	6	7	8	9	10	11	12
<b>2106</b>	855	907	949	1010	1096	1127	1204	1349	1418	1553	1736	1964

OVERALL DIMENSIONS			SEAT DIMENSIONS			BACK DIMENSIONS	
W	D	H	W	D	H	W	H
24.5	27	43.5	21	18.5	17.5-21.5	21	27.5

**RTA 1**

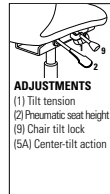

**MB Tilter**  
COM Yardage: 1.75  
Freight Class: 250  
Product Weight (lbs.): 39  
Cubic Feet Per Carton: 11.50

Ergonomic Features:  
A, B, C, M, N, S

	1	2	3	4	5	6	7	8	9	10	11	12
<b>2107</b>	832	877	913	967	1043	1070	1137	1263	1324	1442	1601	1801

OVERALL DIMENSIONS			SEAT DIMENSIONS			BACK DIMENSIONS	
W	D	H	W	D	H	W	H
24.5	26.5	37	19	20	17-21	22	19

**RTA 1**

ENTERPRISE®



model 4560



model 4565

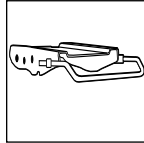

**Multi-Depth Mechanism**  
Seat depth option is available on multi-tilter models. (see notes for more details)





model 4571-3



STANDARD FEATURES

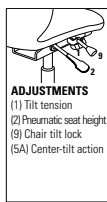

- Gently sculpted seat and back provide lateral and lumbar support.
- Fixed height, impact and scuff resistant curved arms are standard on models 4560, 4561 and 4565. All other models are standard with adjustable height T-arms with teardrop shaped urethane armcaps (TD).
- All models (except armchair) are standard with a five-legged, injection molded base.
- Base and arms are only available in Black (BK).
- Model 4561-SC features a self centering cylinder which swivels and automatically returns to the starting seat location. This model is standard with a flat 5 star base in Black (BK) with C7 glides.
- Vari-Width (WA) width adjustable arm extensions are standard when chair is ordered with adjustable arms. Allows the arms to move away from the seat by 2" on each side to allow space if desired for broader hip widths. C65 casters are standard.
- Not available in Crescent fabric or Leather
- For fully assembled in box, please specify SU. Add \$55.

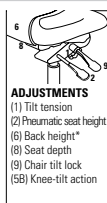
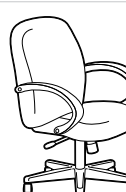
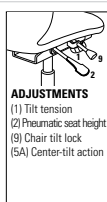

OPTIONAL FEATURES

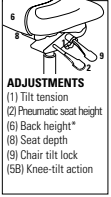

- Optional ballistic nylon outer back fabric available. Resistant to impact damage. Black Only (BKB). Add \$15.
- Available with back edge vinyl bumper guard option (VBG). Add \$18.
- Multi-Depth Mechanism a seat depth option available on multi-tilter models 4570-3 and 4571-3. Allows seat to move forward and backward over a 2" range with 5 locking positions to provide a more shallow or deeper seat. Specify "MD". Add \$94.
- For hard surface flooring casters, please specify C65R. Add \$51.
- For additional arm/caster options, please refer to the Arm and Caster section. Optional casters may be priced higher than the standard casters for your chair and the difference will be charged. Lower priced optional casters will not be credited.



DESCRIPTION	FEATURES	MODEL#	STANDARD TEXTILE GRADES													
			1	2	3	4	5	6	7	8	9	10	11	12		
 <p><b>HB Tilter w/ Fixed Height Loop Arms</b> COM Yardage: 2 Freight Class: 250 Product Weight (lbs.): 39 Cubic Feet Per Carton: 11.50</p> <p>Ergonomic Features: A, B, C, M, N, S</p>	 <p><b>ADJUSTMENTS</b> (1) Tilt tension (2) Pneumatic seat height (9) Chair tilt lock (5A) Center-tilt action</p>	4560	509	562	603	666	755	789	867	1017	1088	1227	1414	1651		
		<b>OVERALL DIMENSIONS</b>			<b>SEAT DIMENSIONS</b>			<b>BACK DIMENSIONS</b>								
		W	D	H	W	D	H	W	H							
24.5	27	45	20.5	18.5	17-22	20	26									
			RTA 1		ups											
 <p><b>HB Knee - Tilter w/ Fixed Height Loop Arms</b> COM Yardage: 2 Freight Class: 250 Product Weight (lbs.): 41 Cubic Feet Per Carton: 13.25</p> <p>Ergonomic Features: A, B, C, J, M, N</p>	 <p><b>ADJUSTMENTS</b> (1) Tilt tension (2) Pneumatic seat height (6) Back height* (8) Seat depth (9) Chair tilt lock (5B) Knee-tilt action</p>	4560-2	692	746	789	852	944	976	1055	1209	1282	1425	1616	1854		
		<b>OVERALL DIMENSIONS</b>			<b>SEAT DIMENSIONS</b>			<b>BACK DIMENSIONS</b>								
		W	D	H	W	D	H	W	H							
24.5	27	45	21	19.5	17-21	21	25									
			RTA 1		ups											
 <p><b>LB Tilter w/ Fixed Height Loop Arms</b> COM Yardage: 1.75 Freight Class: 250 Product Weight (lbs.): 36 Cubic Feet Per Carton: 9.75</p> <p>Ergonomic Features: A, B, C, M, N, S</p>	 <p><b>ADJUSTMENTS</b> (1) Tilt tension (2) Pneumatic seat height (9) Chair tilt lock (5A) Center-tilt action</p>	4561	486	531	569	623	702	730	789	929	992	1114	1279	1484		
		<b>OVERALL DIMENSIONS</b>			<b>SEAT DIMENSIONS</b>			<b>BACK DIMENSIONS</b>								
		W	D	H	W	D	H	W	H							
24.5	26.5	39	20.5	18.5	17-22	20	21									
			RTA 1		ups											



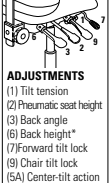



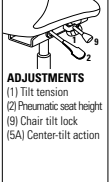

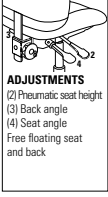

DESCRIPTION	FEATURES	MODEL#	STANDARD TEXTILE GRADES														
			1	2	3	4	5	6	7	8	9	10	11	12			
 <b>MB Conference Chair</b> w/ Fixed Height Loop Arms COM Yardage: 1.75 Freight Class: 250 Product Weight (lbs.): 36 Cubic Feet Per Carton: 9.75		4561-SC	533	579	617	672	753	781	851	986	1049	1173	1341	1551			
			OVERALL DIMENSIONS			SEAT DIMENSIONS			BACK DIMENSIONS								
			W	D	H	W	D	H	W	H							
			24.5	26.5	37	21	19.5	18	21	19							
			<b>RTA 1</b>														

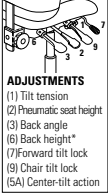
DESCRIPTION	FEATURES	MODEL#	STANDARD TEXTILE GRADES														
			1	2	3	4	5	6	7	8	9	10	11	12			
 <b>LB Knee - Tilter</b> w/ Fixed Height Loop Arms COM Yardage: 1.75 Freight Class: 250 Product Weight (lbs.): 39 Cubic Feet Per Carton: 11.50	 <b>ADJUSTMENTS</b> (1) Tilt tension (2) Pneumatic seat height (6) Back height* (8) Seat depth (9) Chair tilt lock (5B) Knee-tilt action	4561-2	670	718	755	812	894	921	991	1123	1188	1310	1480	1688			
			OVERALL DIMENSIONS			SEAT DIMENSIONS			BACK DIMENSIONS								
			W	D	H	W	D	H	W	H							
			25	26.5	39	12	19.5	17-21	21	19							
			<b>RTA 1</b>														
			Ergonomic Features: A, B, C, J, M, N														

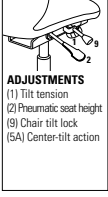

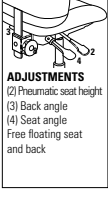

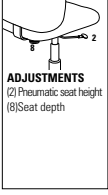
DESCRIPTION	FEATURES	MODEL#	STANDARD TEXTILE GRADES														
			1	2	3	4	5	6	7	8	9	10	11	12			
 <b>Armchair</b> w/ Fixed Height Loop Arms COM Yardage: 1.75 Freight Class: 250 Product Weight (lbs.): 33 Cubic Feet Per Carton: 10		4565	486	531	569	623	702	730	799	929	992	1114	1279	1484			
			OVERALL DIMENSIONS			SEAT DIMENSIONS			BACK DIMENSIONS								
			W	D	H	W	D	H	W	H							
			24.5	26.5	37	19.5	18-19.5	16.5-20.5	18	22.5							
			<b>RTA 2</b>														
			Ergonomic Features: M, N														

DESCRIPTION	FEATURES	MODEL#	STANDARD TEXTILE GRADES														
			1	2	3	4	5	6	7	8	9	10	11	12			
 <b>HB Multi - Tilter</b> w/ Adjustable (TD) Arms COM Yardage: 2 Freight Class: 150 Product Weight (lbs.): 54 Cubic Feet Per Carton: 11	 <b>ADJUSTMENTS</b> (1) Tilt tension (2) Pneumatic seat height (3) Back angle (6) Back height* (7) Forward tilt lock (9) Chair tilt lock (5A) Center-tilt action	4570-3	905	957	1000	1063	1152	1187	1263	1413	1485	1624	1811	2047			
			OVERALL DIMENSIONS			SEAT DIMENSIONS			BACK DIMENSIONS								
			W	D	H	W	D	H	W	H							
			26.5	26.5	47	22	19	17-21	21.5	26-28							
			<b>RTA 2</b>														
			Ergonomic Features: A, B, C, D, F, G, H, M, N, Q, S														

DESCRIPTION	FEATURES	MODEL#	STANDARD TEXTILE GRADES														
			1	2	3	4	5	6	7	8	9	10	11	12			
 <b>HB Tilter</b> w/ Adjustable (TD) Arms COM Yardage: 2 Freight Class: 150 Product Weight (lbs.): 47 Cubic Feet Per Carton: 11.50	 <b>ADJUSTMENTS</b> (1) Tilt tension (2) Pneumatic seat height (9) Chair tilt lock (5A) Center-tilt action	4570-4	806	861	903	968	1054	1088	1166	1316	1388	1525	1949	806			
			OVERALL DIMENSIONS			SEAT DIMENSIONS			BACK DIMENSIONS								
			W	D	H	W	D	H	W	H							
			26.5	27	47.5	22	19	17-21	21.5	26-28							
			<b>RTA 2</b>														
			Ergonomic Features: A, B, C, H, M, N, Q, S														

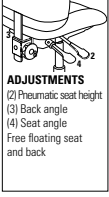
DESCRIPTION	FEATURES	MODEL#	STANDARD TEXTILE GRADES												
			1	2	3	4	5	6	7	8	9	10	11	12	
 <p><b>HB Operator</b> w/ Adjustable (TD) Arms COM Yardage: 2 Freight Class: 150 Product Weight (lbs.): 46 Cubic Feet Per Carton: 11</p>	 <p><b>ADJUSTMENTS</b> (2) Pneumatic seat height (3) Back angle (4) Seat angle Free floating seat and back</p>	<b>4570-5</b>	897	950	992	1054	1144	1178	1255	1404	1478	1615	1805	2037	
			<b>OVERALL DIMENSIONS</b>			<b>SEAT DIMENSIONS</b>			<b>BACK DIMENSIONS</b>						
			<b>W</b>	<b>D</b>	<b>H</b>	<b>W</b>	<b>D</b>	<b>H</b>	<b>W</b>	<b>H</b>					
			26.5	26.5	47	22	19.5	17-21	21.5	26-28					
			<b>RTA 2</b>												
 <p><b>MB Multi-Tiler</b> w/ Adjustable (TD) Arms COM Yardage: 1.75 Freight Class: 150 Product Weight (lbs.): 52 Cubic Feet Per Carton: 9.50</p>	 <p><b>ADJUSTMENTS</b> (1) Tilt tension (2) Pneumatic seat height (3) Back angle (6) Back height* (7) Forward tilt lock (9) Chair tilt lock (5A) Center-tilt action</p>	<b>4571-3</b>	821	867	904	957	1037	1064	1135	1264	1326	1450	1612	1819	
			<b>OVERALL DIMENSIONS</b>			<b>SEAT DIMENSIONS</b>			<b>BACK DIMENSIONS</b>						
			<b>W</b>	<b>D</b>	<b>H</b>	<b>W</b>	<b>D</b>	<b>H</b>	<b>W</b>	<b>H</b>					
			26.5	26	41	22	19	17-21	21.5	20.5-22.5					
			<b>RTA 2</b>												
 <p><b>MB Tilter</b> w/ Adjustable (TD) Arms COM Yardage: 1.75 Freight Class: 150 Product Weight (lbs.): 46 Cubic Feet Per Carton: 11.50</p>	 <p><b>ADJUSTMENTS</b> (1) Tilt tension (2) Pneumatic seat height (9) Chair tilt lock (5A) Center-tilt action</p>	<b>4571-4</b>	740	786	823	878	956	986	1052	1183	1247	1369	1533	1738	
			<b>OVERALL DIMENSIONS</b>			<b>SEAT DIMENSIONS</b>			<b>BACK DIMENSIONS</b>						
			<b>W</b>	<b>D</b>	<b>H</b>	<b>W</b>	<b>D</b>	<b>H</b>	<b>W</b>	<b>H</b>					
			26.5	26	41.5	22	19	17-21	21.5	20.5-22.5					
			<b>RTA 2</b>												
 <p><b>LB Operator</b> w/ Adjustable (TD) Arms COM Yardage: 1.75 Freight Class: 150 Product Weight (lbs.): 43 Cubic Feet Per Carton: 8.25</p>	 <p><b>ADJUSTMENTS</b> (2) Pneumatic seat height (3) Back angle (4) Seat angle Free floating seat and back</p>	<b>4573-5</b>	799	846	881	938	1017	1045	1113	1245	1306	1428	1593	1797	
			<b>OVERALL DIMENSIONS</b>			<b>SEAT DIMENSIONS</b>			<b>BACK DIMENSIONS</b>						
			<b>W</b>	<b>D</b>	<b>H</b>	<b>W</b>	<b>D</b>	<b>H</b>	<b>W</b>	<b>H</b>					
			26.5	25	38	22	19.5	17-21	19	18.5-20.5					
			<b>RTA 2</b>												
 <p><b>LB Task</b> w/ Adjustable (TD) Arms COM Yardage: 1.75 Freight Class: 150 Product Weight (lbs.): 39 Cubic Feet Per Carton: 7</p>	 <p><b>ADJUSTMENTS</b> (2) Pneumatic seat height (8) Seat depth</p>	<b>4573-6</b>	648	695	732	788	867	895	963	1094	1155	1279	1442	1647	
			<b>OVERALL DIMENSIONS</b>			<b>SEAT DIMENSIONS</b>			<b>BACK DIMENSIONS</b>						
			<b>W</b>	<b>D</b>	<b>H</b>	<b>W</b>	<b>D</b>	<b>H</b>	<b>W</b>	<b>H</b>					
			26.5	25.5	40.5	22	17-18.5	16.5-20.5	19	20					
			<b>RTA 2</b>												

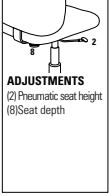

DESCRIPTION	FEATURES	MODEL#	STANDARD TEXTILE GRADES													
			1	2	3	4	5	6	7	8	9	10	11	12		
 <p><b>LB Operator</b> Armless COM Yardage: 1.75 Freight Class: 150 Product Weight (lbs.): 36 Cubic Feet Per Carton: 7</p>	 <p><b>ADJUSTMENTS</b> (2) Pneumatic seat height (3) Back angle (4) Seat angle Free floating seat and back.</p>	<b>4577-5</b>	669	715	752	806	885	914	981	1114	1175	1298	1461	1668		
			<b>OVERALL DIMENSIONS</b>			<b>SEAT DIMENSIONS</b>			<b>BACK DIMENSIONS</b>							
			<b>W</b>	<b>D</b>	<b>H</b>	<b>W</b>	<b>D</b>	<b>H</b>	<b>W</b>	<b>H</b>						
			26.5	25.5	40.5	22	19.5	17-21	19	18.5-20.5						
			<b>RTA 2</b>													
 <p><b>LB Task</b> Armless COM Yardage: 7 Freight Class: 150 Product Weight (lbs.): 33 Cubic Feet Per Carton: 7</p>	 <p><b>ADJUSTMENTS</b> (2) Pneumatic seat height (8) Seat depth</p>	<b>4577-6</b>	520	567	604	660	739	767	834	968	1027	1150	1315	1520		
			<b>OVERALL DIMENSIONS</b>			<b>SEAT DIMENSIONS</b>			<b>BACK DIMENSIONS</b>							
			<b>W</b>	<b>D</b>	<b>H</b>	<b>W</b>	<b>D</b>	<b>H</b>	<b>W</b>	<b>H</b>						
			22.5	25.5	40.5	22	17-18.5	16.5-20.5	19	22						
			<b>RTA 2</b>													

FACTOR



model 5540



model 5541

STANDARD MODEL MECHANISM:

Task Basic Swivel mechanism (-6)

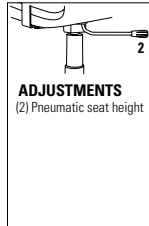

Ergonomic features:  
C

MECHANISM OPTIONS:

Tilter mechanism (-4)

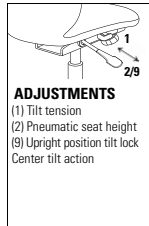

Ergonomic features:  
A, B, C, S

Weight sensing  
Synchro-tilter mechanism (-8)

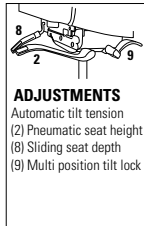

Ergonomic features:  
A, B, C, E, L

STANDARD FEATURES

- Standard with (-6) Task Basic Swivel mechanism.
- Adjustable lumbar support is standard on all models. Height adjustable and split down the middle to flex independently side-to-side.
- (U1) Standard with fixed, forward swept arms. Self-skinned urethane (SSU) armcaps will match the selected frame color (Black or Shadow); Cloud frame comes with coordinating Fog armcaps.
- Standard with five prong, injection molded, fiberglass reinforced nylon Black base with (C82) dual wheel carpet casters. Base will match frame color selection; casters coordinate with base color.
- Upholstery options: fabric, vinyl or leather. Not available in leather/mock leather combination.
- Standard Ergonomic features: C, D, M, N, U (see Ergonomic Features & Benefits page).

OPTIONAL FEATURES

- Weight Sensing Synchro-Tilter control mechanism (-8) includes side activated sliding seat depth adjustment.
- Optional Tilter mechanism (-4) is also available.
- (U2) Optional height adjustable arms are available. Ergonomic Feature: H
- (U3) Optional height adjustable arms with sliding armcaps are available. Ergonomic Feature: H,Q
- For additional arms/caster options, please refer to the Arm and Caster section. Optional casters may be priced higher than the standard casters for your chair and the difference will be charged. Lower priced optional casters will not be credited.
- For fully assembled in box, please specify (SU). Add \$55.

Please add option codes in the following order:

- **Model number**  
**5540** High back with arms.  
**5540NA** High back, no arms.  
**5541** Medium back with arms.  
**5541NA** Medium back, no arms.  
**5546** Medium task stool with arms (Task Basic Swivel mechanism only).  
**5546NA** Medium task stool, no arms (Task Basic Swivel mechanism only).
- **Mesh back** (colors shown on website)  
**(P-1)** Snow **(P-8)** Mocha  
**(P-2)** Sand **(P-9)** Eggplant  
**(P-3)** Pewter **(Q-1)** Buzz Blue  
**(P-4)** Silver Grey **(Q-2)** Poppy  
**(P-5)** Charcoal **(Q-3)** Pumpkin  
**(P-6)** Black **(Q-4)** Lime
- **Textile**  
Specify textile code for seat.
- **Frame color**  
**(BK)** Black. (Standard).  
**(SH)** Shadow. Add \$35 for armless models. Add \$45 for models with arms.  
**(IC)** Cloud. Add \$35 for armless models. Add \$45 for models with arms.
- **Arms**  
**(A-U1)** Fixed height arms. (Standard).  
**(A-U2)** Height adjustable arms. Add \$15.  
**(A-U3)** Height adjustable arms w/sliding armcaps. Add \$40.
- **Base**  
**(B7)** Nylon base. (Color matches frame).  
**(A7)** Polished Aluminum base. Add \$121.
- **Mechanism**  
**(-4)** Tilter mechanism. Add \$15.  
**(-6)** Task Basic Swivel mechanism (standard). No upcharge.  
**(-8)** Weight sensing synchro-tilter mechanism w/ standard seat slider. Add \$85.
- **Casters**  
**(C82)** Carpet Casters (Standard).  
**(C82R)** Rubber Hard Floor Casters. Add \$68.

EXAMPLE FACTOR ORDER CODE:

5541	-P-5	-FU75	-8	-SH	A-U3	-B7	-C82R
------	------	-------	----	-----	------	-----	-------

Model # Mesh Back Textile Mechanism Frame Color Arms Base Casters

DESCRIPTION

FEATURES

MODEL#











STANDARD TEXTILE GRADES



**High Back**  
COM Yardage: 1  
Freight Class: 250  
Product Weight (lbs.): 37 (armless 31)  
Cubic Feet Per Carton: 10.5

MODEL#	STANDARD TEXTILE GRADES											
	1	2	3	4	5	6	7	8	9	10	11	12
5540 With arms	525	560	570	600	640	660	695	755	800	850	950	1060
OVERALL DIMENSIONS			SEAT DIMENSIONS			BACK DIMENSIONS						
W	D	H	W	D	H	W	H					
26.5	24	41.5	20	17.5	16-20	18.5	23					

RTA 1 1 per carton

DESCRIPTION	FEATURES	MODEL#	STANDARD TEXTILE GRADES												
			1	2	3	4	5	6	7	8	9	10	11	12	
 <p><b>High Back</b> COM Yardage: 1 Freight Class: 250 Product Weight (lbs.): 37 (armless 31) Cubic Feet Per Carton: 10.5</p>		<b>5540NA</b>	490	520	535	565	610	625	665	725	770	820	925	1040	
			<b>OVERALL DIMENSIONS SEAT DIMENSIONS BACK DIMENSIONS</b>												
			<b>W</b>	<b>D</b>	<b>H</b>	<b>W</b>	<b>D</b>	<b>H</b>		<b>W</b>	<b>H</b>				
			20	24	41.5	20	17.5	16-20		18.5	23				
			<b>RTA 1</b>		1 per carton										
 <p><b>Medium Back</b> COM Yardage: 1 Freight Class: 250 Product Weight (lbs.): 36 (armless 30) Cubic Feet Per Carton: 10.5</p>		<b>5541</b>	495	520	540	570	610	625	660	720	765	810	915	1020	
			<b>OVERALL DIMENSIONS SEAT DIMENSIONS BACK DIMENSIONS</b>												
			<b>W</b>	<b>D</b>	<b>H</b>	<b>W</b>	<b>D</b>	<b>H</b>		<b>W</b>	<b>H</b>				
			26.5	24	39	20	17.5	16-20		18.5	20				
			<b>RTA 1</b>		1 per carton										
 <p><b>Medium Back</b> COM Yardage: 1 Freight Class: 250 Product Weight (lbs.): 36 (armless 30) Cubic Feet Per Carton: 10.5</p>		<b>5541NA</b>	460	485	505	535	575	595	630	690	735	785	890	1000	
			<b>OVERALL DIMENSIONS SEAT DIMENSIONS BACK DIMENSIONS</b>												
			<b>W</b>	<b>D</b>	<b>H</b>	<b>W</b>	<b>D</b>	<b>H</b>		<b>W</b>	<b>H</b>				
			20	24	39	20	17.5	16-20		18.5	20				
			<b>RTA 1</b>		1 per carton										
 <p><b>Stool</b> COM Yardage: 1 Freight Class: 250 Product Weight (lbs.): 40 (armless 34) Cubic Feet Per Carton: 10.5</p>		<b>5546</b>	610	635	655	685	725	745	780	840	885	935	1040	1150	
			<b>OVERALL DIMENSIONS SEAT DIMENSIONS BACK DIMENSIONS</b>												
			<b>W</b>	<b>D</b>	<b>H</b>	<b>W</b>	<b>D</b>	<b>H</b>		<b>W</b>	<b>H</b>				
			26.5	23.5	49	20	17.5	23.75-33.75		18.5	20.5				
			<b>RTA 1</b>		1 per carton										
 <p><b>Stool</b> COM Yardage: 1 Freight Class: 250 Product Weight (lbs.): 40 (armless 34) Cubic Feet Per Carton: 10.5</p>		<b>5546NA</b>	575	605	625	650	700	715	750	810	860	910	1015	1130	
			<b>OVERALL DIMENSIONS SEAT DIMENSIONS BACK DIMENSIONS</b>												
			<b>W</b>	<b>D</b>	<b>H</b>	<b>W</b>	<b>D</b>	<b>H</b>		<b>W</b>	<b>H</b>				
			20	23.5	49	20	17.5	23.75-33.75		18.5	20.5				
			<b>RTA 1</b>		1 per carton										

G1 ERGO SELECT™



model 7331



model 7333

MECHANISM OPTIONS:

Synchro-tilter mechanism (-0)

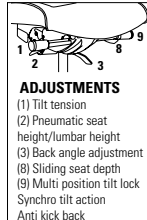

ADJUSTMENTS

- (1) Tilt tension
- (2) Pneumatic seat height/lumbar height
- (3) Back angle adjustment
- (8) Sliding seat depth
- (9) Multi position tilt lock
- Synchro tilt action
- Anti kick back

Ergonomic features:

A, B, C, D, E, G, H, L, M, N, Q, R, U

Weight sensing

synchro-tilter mechanism (-8)

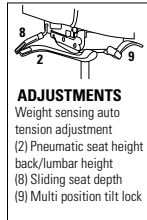

ADJUSTMENTS

- Weight sensing auto tension adjustment
- (2) Pneumatic seat height back/lumbar height
- (8) Sliding seat depth
- (9) Multi position tilt lock

Ergonomic features:

A, B, C, D, E, H, L, M, N, Q, R, U

Multi-tilter mechanism (-3)

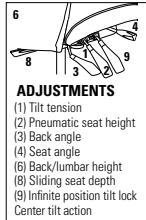

ADJUSTMENTS

- (1) Tilt tension
- (2) Pneumatic seat height
- (3) Back angle
- (4) Seat angle
- (6) Back/lumbar height
- (8) Sliding seat depth
- (9) Infinite position tilt lock
- Center tilt action

Ergonomic features:

A, B, C, D, E, F, G, H, M, N, Q, R, S, U

Posture task mechanism (-7)

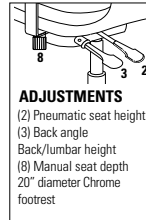

ADJUSTMENTS

- (2) Pneumatic seat height
- (3) Back angle
- Back/lumbar height
- (8) Manual seat depth
- 20" diameter Chrome footrest

Ergonomic features:

C, D, G, H, M, N, Q, R, U, V

STANDARD FEATURES

- G1 Ergo Select is designed for a great 'sit', providing exceptional support and comfort throughout the work day.
- Available in three back heights and three seat sizes, varying in depth and width, to fit a person's body type and movements while at work.
- Adjustable lumbar support standard on all models.
- Stitch detail on edges of seat and back is discrete, using matched thread as standard.
- Choice of three mechanisms; synchro-tilter, multi-tilter and weight sensing synchro-tilter. Stool model available with posture task mechanism only.
- Standard with Global's high quality Soft Descent™ pneumatic lift which slowly and gently lowers the seat height of the chair making it easy to obtain the exact seat height you desire.
- Standard with height and width adjustable (G5) arms with sliding armcaps. Armcaps also articulate inwards and outwards to aim toward the keyboard or mouse area.
- G1 Ergo Select is fully compliant with latest BIFMA G1, GSA, and CGSB specifications.
- Five prong, injection molded, fiberglass reinforced nylon Black base with (C82) dual wheel carpet casters.
- Upholstery options: fabric, vinyl or leather. Leather/mock leather combination not available

OPTIONAL FEATURES

- Upholstery is available with exaggerated top stitch detail (heavier thread). Fourteen coordinating or contrasting colors may be selected. Please specify.
- Optional Ergo Select arms are height (4") and width adjustable with sliding armcaps. Armcaps also articulate inwards (25°) and outwards (25°) to aim toward the keyboard or mouse area.
- For additional arms/caster options, please refer to the Arm and Caster section (page 374). Optional casters may be priced higher than the standard casters for your chair and the difference will be charged. Lower priced optional casters will not be credited. Please add option codes in the following order:

Model number

- 7331 Medium back with arms
- 7332 High back with arms
- 7333 Extended high back with arms
- 7336 Medium task stool with arms (posture task mechanism only)
- 7336NA Medium task stool, armless (posture task mechanism only)

Textile

Specify textile codes for back and seat

Mechanism (No Upcharge)

- (-0) Synchro-tilter mechanism
- (-3) Multi-tilter mechanism
- (-8) Weight sensing synchro-tilter mechanism
- (-7) Posture task mechanism (models 7336 / 7336NA only)

Seat Size

- (P) Petite seat
- (STAN) Standard seat
- (GS) Generous seat

Arms

- (G5) G5 arms ..... **Standard**
- (H1) Ergo Select arms ..... **Add \$65**
- (H2) Ergo Select arms w/wide armcaps ..... **Add \$89**

Base

- (B7) Black nylon B7B base ..... **Standard**
- (A7) Polished aluminum B7A base..... **Add \$121**

Cylinder

Please refer to "Cylinder Selection" section of the price book for cylinder options.

Casters

- (C82) Dual wheel carpet casters..... **Standard**
- (C82R) Dual wheel hard floor casters ..... **Add \$68**





Stitch detail

- (MS) Color matched stitching
- Decorative top stitch ..... **No upcharge**
- (XP) Black (XB) Beige
- (XG) Copen (XA) Graphite
- (XH) Mahogany (XJ) Natural
- (XH) Navy #3 (XD) New Grey
- (XF) Nickel (XN) Off-White
- (XL) Rubytone (XI) Scarlett
- (XC) Smoke (XE) Taupe (colors shown on website)

EXAMPLE G1 ERGO SELECT ORDER CODE:

7332	-WA53	-WA53	-8	-STAN	-H1	-B7	-4L	-C82	-MS
Model #	Back fabric	Seat fabric	Mechanism	Seat size	Arms	Base	Cylinder	Casters	Stitch detail

G1 Ergo Select dimensional information: based on measurements with multi-tilter mechanism				
	Distance between arms	Standard arm height	Seat depth range	Standard seat height
<b>Petite seat (P)</b> Soft Descent 4" lift & (H1) arms	15.25" - 20.75" = 5.5" adjustment	7.3" - 11.4"	15.75" - 18.75"	16.5" - 20.5"
<b>Standard seat (STAN)</b> Soft Descent 4" lift & (H1) arms	16" - 21.5" = 5.5" adjustment		16.5" - 19.5"	
<b>Generous seat (GS)</b> Soft Descent 4" lift & (H1) arms	17.25" - 22.75" = 5.5" adjustment		17.25" - 19.5"	

DESCRIPTION	FEATURES	MODEL#	STANDARD TEXTILE GRADES													
			1	2	3	4	5	6	7	8	9	10	11	12		
 <p><b>Medium Back</b> COM Yardage: 1.65 Freight Class: 125 Product Weight (lbs.): 66 Cubic Feet Per Carton: 10.50</p>	<p>See series notes for mechanism options.</p> <p>* Standard seat</p>	<b>7331</b>	953	995	1028	1078	1149	1182	1247	1349	1428	1515	1696	1887		
			<b>OVERALL DIMENSIONS</b>			<b>SEAT DIMENSIONS*</b>			<b>BACK DIMENSIONS</b>							
			<b>W</b>	<b>D</b>	<b>H</b>	<b>W</b>	<b>D</b>	<b>H</b>	<b>W</b>	<b>H</b>						
			24	21.5	41	19.75	16.5-19.5	16.5-20.5	19	22						
			<b>RTA 1</b>			1 per carton										
 <p><b>High Back</b> COM Yardage: 1.75 Freight Class: 125 Product Weight (lbs.): 68 Cubic Feet Per Carton: 10.50</p>	<p>See series notes for mechanism options.</p> <p>* Standard seat</p>	<b>7332</b>	1005	1050	1085	1139	1214	1250	1318	1427	1512	1605	1798	2004		
			<b>OVERALL DIMENSIONS</b>			<b>SEAT DIMENSIONS*</b>			<b>BACK DIMENSIONS</b>							
			<b>W</b>	<b>D</b>	<b>H</b>	<b>W</b>	<b>D</b>	<b>H</b>	<b>W</b>	<b>H</b>						
			24.5	23	44.5	19.75	16.5-19.5	16.5-20.5	19	24.5						
			<b>RTA 1</b>			1 per carton										
 <p><b>Extended High Back</b> COM Yardage: 2 Freight Class: 125 Product Weight (lbs.): 70 Cubic Feet Per Carton: 11</p>	<p>See series notes for mechanism options.</p> <p>* Standard seat</p>	<b>7333</b>	1056	1108	1149	1210	1297	1338	1417	1542	1640	1747	1969	2206		
			<b>OVERALL DIMENSIONS</b>			<b>SEAT DIMENSIONS*</b>			<b>BACK DIMENSIONS</b>							
			<b>W</b>	<b>D</b>	<b>H</b>	<b>W</b>	<b>D</b>	<b>H</b>	<b>W</b>	<b>H</b>						
			26	24	50	19.75	16.5-19.5	16.5-20.5	19	27						
			<b>RTA 1</b>			1 per carton										
 <p><b>Medium Back Stool</b> COM Yardage: 1.65 Freight Class: 150 Product Weight (lbs.): 59 Cubic Feet Per Carton: 10.50</p>	<p>See series notes for mechanism options.</p> <p>* Standard seat</p>	<b>7336</b>	1030	1073	1106	1156	1227	1260	1325	1427	1506	1594	1775	1968		
			<b>7336NA</b> Armless	953	997	1030	1081	1153	1187	1252	1355	1435	1524	1707	1902	
		<b>OVERALL DIMENSIONS</b>			<b>SEAT DIMENSIONS*</b>			<b>BACK DIMENSIONS</b>								
		<b>W</b>	<b>D</b>	<b>H</b>	<b>W</b>	<b>D</b>	<b>H</b>	<b>W</b>	<b>H</b>							
24	22.5	46	18.5	16.5	22-30	19	22									
			<b>RTA 1</b>			1 per carton										

G20



model 6007



**Lumbar Support**  
Automatic lumbar tension mechanism naturally adjusts to your posture while in upright or reclined position. The lumbar is also height adjustable.



Optional Fixed "C" Arm



STANDARD FEATURES

- The striped mesh back is composed of an alternating vertical rows of clear elastomeric yarns and polyester yarns. This provides a very responsive back support.
- The inside of the mesh back is black while the outside of the mesh is silver to coordinate with the polished aluminum trim. Only available in a black mesh back, black arms and frame.
- Synchronized mechanism allows the back to smoothly tilt, while the seat gently reclines and slides to the rear. The seat does not lift up and keeps feet planted on floor. Four tilt positions, locks and infinite free float.
- Height adjustable **SSU** arms with sliding (forward and backward) and pivot armcaps.
- Independent lumbar adjustment on back (2.5" of height adjustment range on each side)

- Adjustable tilt tension knob located beside the seat, simply rotate the knob for user preference.
- Side activated sliding seat depth adjustment (**MD**) is standard and provides 2" of adjustment.
- The base and frame are standard in polished aluminum with C82 dual wheel carpet casters.

OPTIONAL FEATURES

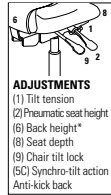
- An optional black nylon base (**B7B**) is available. No upcharge.
- Optional fixed aluminum **C** arms (**DF**) are available. No upcharge.
- Please refer to "Cylinder Selection" section of the price book for additional cylinder options.
- For hard surface flooring casters, please specify (**C9R**). Add \$68
- Seat is available in Fabric, Vinyl or Leather.
- For fully assembled in box, please specify **SU**. Add \$55.

DESCRIPTION	FEATURES	MODEL#	STANDARD TEXTILE GRADES																															
			1	2	3	4	5	6	7	8	9	10	11	12																				
 <p><b>Synchro - Tilter</b> COM Yardage: 1 Freight Class: 150 Product Weight (lbs.): 53 Cubic Feet Per Carton: 11</p>	 <p><b>ADJUSTMENTS</b> (1) Tilt tension (2) Pneumatic seat height (6) Back height* (8) Seat depth (9) Chair tilt lock (5C) Synchro-tilt action Anti-kick back</p>	<b>6007</b>	1091	1118	1139	1170	1212	1228	1265	1338	1373	1440	1532	1646																				
		<b>6007L</b> Leather	-	-	-	-	-	-	-	-	1285	1332	1391	1491	1605																			
		<table border="1"> <thead> <tr> <th colspan="3">OVERALL DIMENSIONS</th> <th colspan="3">SEAT DIMENSIONS</th> <th colspan="2">BACK DIMENSIONS</th> </tr> <tr> <th>W</th> <th>D</th> <th>H</th> <th>W</th> <th>D</th> <th>H</th> <th>W</th> <th>H</th> </tr> </thead> <tbody> <tr> <td>25.5</td> <td>23</td> <td>41.5</td> <td>19.5</td> <td>18.5</td> <td>17-21</td> <td>19</td> <td>22</td> </tr> </tbody> </table>	OVERALL DIMENSIONS			SEAT DIMENSIONS			BACK DIMENSIONS		W	D	H	W	D	H	W	H	25.5	23	41.5	19.5	18.5	17-21	19	22								
OVERALL DIMENSIONS			SEAT DIMENSIONS			BACK DIMENSIONS																												
W	D	H	W	D	H	W	H																											
25.5	23	41.5	19.5	18.5	17-21	19	22																											
	Ergonomic Features: A, B, C, D, E, H, L, M, N, Q, R, U		<b>RTA 4</b>																															

GLOBAL ACCORD™



model 2670-2



model 2670-2



**Polished Aluminum Base**  
Arched aluminum spider base on all models add a distinctive look to the Global Accord series.



model 2671-4



model 2676-2

STANDARD FEATURES

- Global Accord offers an elegant and refined design that features a sling back style that molds to and evenly supports the back and spine.
- Cast aluminum with a mirror finish accent the arms and base.
- Soft touch self-skinned urethane armcaps are available in Black Only. There are no arm options for the Accord series.
- All models are standard with an arched aluminum spider base and **C1** casters.



OPTIONAL FEATURES

- Available in all standard GLOBAL carded fabrics, vinyls, and leathers with the EXCEPTION of Jenny and Quilt (Grade 1).
- For fully assembled in box, please specify **SU**. Add \$55.

- Mesh models are available in any of the 24 standard Vue Mesh colors. Please specify color: Sandy Beach (**VU10**), Dessert Sand (**VU11**), Orange Sunset (**VU12**), Chocolate Fountain (**VU13**), Artic Blue (**VU14**), Quarry Grey (**VU15**), Tidal Wave (**VU16**), Ivy Moss (**VU17**), Red Rose (**VU18**), Black (**VU19**), White (**VU20**), Lime (**VU21**), Chartreuse (**VU23**), Pool Blue (**VU26**), Sky (**VU28**), Ice (**VU30**), Primary Blue (**VU32**), Tangerine (**VU34**), Paprika (**VU37**), Grain (**VU40**), Yellow (**VU43**), Silver Grey (**VU55**), Silver (**VU63**), Hot Pink (**VU65**) and Red Mittens (**VU70**)
- An optional (**B5**) black plastic base with Aluminum Arms combination. No upcharge.
- Please refer to the "Casters Selection" section of the price book for caster options. Optional casters may be priced higher than the standard casters for your chair and the difference will be charged. Lower priced optional casters will not be credited.
- For hard surface flooring casters, please specify (**C9R**). Add \$51
- For Memory Foam, specify (**MF**) and add \$84.

DESCRIPTION FEATURES MODEL# STANDARD TEXTILE GRADES



**HB Knee - Tilter**  
COM Yardage: 2  
Freight Class: 150  
Product Weight (lbs.): 56  
Cubic Feet Per Carton: 13

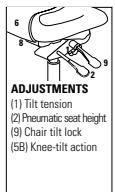

Ergonomic Features:  
A, B, C, J, M, N, U

	1	2	3	4	5	6	7	8	9	10	11	12
<b>2670-2</b>	1166	1216	1256	1316	1413	1448	1524	1672	1745	1884	2072	2307

<b>2670LM-2</b>	-	-	-	-	1406	-	-	1672	1745	1884	2072	2307
Leather/Mock Leather												

OVERALL DIMENSIONS			SEAT DIMENSIONS			BACK DIMENSIONS		
W	D	H	W	D	H	W	H	
25	25	44	20	19	16.5-20.5	18.5	23	



**HB Tilter**  
COM Yardage: 2  
Freight Class: 150  
Product Weight (lbs.): 43  
Cubic Feet Per Carton: 10.75

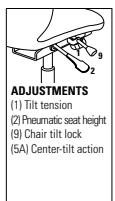

Ergonomic Features:  
A, B, C, M, N, S, U

	1	2	3	4	5	6	7	8	9	10	11	12
<b>2670-4</b>	959	1011	1050	1109	1194	1241	1318	1431	1540	1630	1867	2101

<b>2670LM-4</b>	-	-	-	-	1204	-	-	1442	1544	1641	1870	2104
Leather/Mock Leather												

OVERALL DIMENSIONS			SEAT DIMENSIONS			BACK DIMENSIONS		
W	D	H	W	D	H	W	H	
25	25	44	20	19	16.5-21.5	18.5	23	



**MB Knee - Tilter**  
COM Yardage: 1.75  
Freight Class: 150  
Product Weight (lbs.): 50  
Cubic Feet Per Carton: 10.75

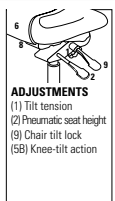









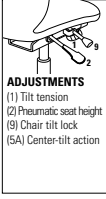

Ergonomic Features:  
A, B, C, J, M, N, U

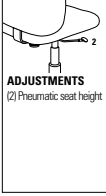
	1	2	3	4	5	6	7	8	9	10	11	12
<b>2671-2</b>	1137	1187	1227	1285	1369	1380	1450	1607	1642	1807	1929	2134

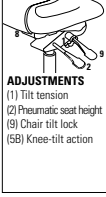

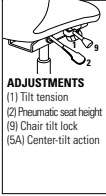

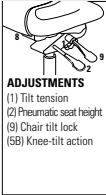
<b>2671LM-2</b>	-	-	-	-	1347	-	-	1583	1687	1782	2012	2248
Leather/Mock Leather												

OVERALL DIMENSIONS			SEAT DIMENSIONS			BACK DIMENSIONS		
W	D	H	W	D	H	W	H	
25	25	37	20	19	16.5-20.5	18.5	18	

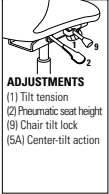

DESCRIPTION	FEATURES	MODEL#	STANDARD TEXTILE GRADES											
			1	2	3	4	5	6	7	8	9	10	11	12
 <b>MB Tilter</b> COM Yardage: 1.75 Freight Class: 250 Product Weight (lbs.): 40 Cubic Feet Per Carton: 10.75	 <b>ADJUSTMENTS</b> (1) Tilt tension (2) Pneumatic seat height (9) Chair tilt lock (5A) Center-tilt action	2671-4	929	979	1021	1079	1164	1174	1245	1401	1435	1600	1722	1929
		2671LM-4	-	-	-	-	1173	-	-	1411	1516	1610	1841	2074
		Leather/Mock Leather			<b>OVERALL DIMENSIONS</b>			<b>SEAT DIMENSIONS</b>			<b>BACK DIMENSIONS</b>			
			<b>W</b>	<b>D</b>	<b>H</b>	<b>W</b>	<b>D</b>	<b>H</b>	<b>W</b>	<b>H</b>				
	25	25	37	20	19	16.5-21.5	18.5	18						
		Ergonomic Features: A, B, C, M, N, S, U	<b>RTA 1</b>											
 <b>MB Stool</b> COM Yardage: 1.75 Freight Class: 150 Product Weight (lbs.): 48 Cubic Feet Per Carton: 10.75	 <b>ADJUSTMENTS</b> (2) Pneumatic seat height	2672-6	1141	1187	1221	1276	1350	1375	1441	1565	1624	1741	1898	2094
		2672LM-6	-	-	-	-	1334	-	-	1568	1640	1756	1931	2140
		Leather/Mock Leather			<b>OVERALL DIMENSIONS</b>			<b>SEAT DIMENSIONS</b>			<b>BACK DIMENSIONS</b>			
			<b>W</b>	<b>D</b>	<b>H</b>	<b>W</b>	<b>D</b>	<b>H</b>	<b>W</b>	<b>H</b>				
	25	26	43.5	20	19	21-29	18.5	18						
		Ergonomic Features: C, M, N, U	<b>RTA 1</b>											
 <b>Mesh HB Knee - Tilter</b> COM Yardage: 1 Freight Class: 150 Product Weight (lbs.): 56 Cubic Feet Per Carton: 13	 <b>ADJUSTMENTS</b> (1) Tilt tension (2) Pneumatic seat height (9) Chair tilt lock (5B) Knee-tilt action	2676-2	1263	1289	1310	1341	1383	1399	1436	1509	1544	1611	1703	1817
		2676LM-2	-	-	-	-	1389	-	-	1522	1562	1629	1731	1849
		Leather/Mock Leather			<b>OVERALL DIMENSIONS</b>			<b>SEAT DIMENSIONS</b>			<b>BACK DIMENSIONS</b>			
			<b>W</b>	<b>D</b>	<b>H</b>	<b>W</b>	<b>D</b>	<b>H</b>	<b>W</b>	<b>H</b>				
	25	25	44	20	19	18-22	18.5	23						
		Ergonomic Features: A, B, C, J, M, N, U	<b>RTA 1</b>											
 <b>Mesh HB Tilter</b> COM Yardage: 1 Freight Class: 150 Product Weight (lbs.): 43 Cubic Feet Per Carton: 10.75	 <b>ADJUSTMENTS</b> (1) Tilt tension (2) Pneumatic seat height (9) Chair tilt lock (5A) Center-tilt action	2676-4	1055	1082	1103	1133	1176	1192	1229	1302	1337	1404	1496	1610
		2676LM-4	-	-	-	-	1185	-	-	1318	1358	1426	1526	1645
		Leather/Mock Leather			<b>OVERALL DIMENSIONS</b>			<b>SEAT DIMENSIONS</b>			<b>BACK DIMENSIONS</b>			
			<b>W</b>	<b>D</b>	<b>H</b>	<b>W</b>	<b>D</b>	<b>H</b>	<b>W</b>	<b>H</b>				
	25	25	42.5	20	19	16-20	18.5	23						
		Ergonomic Features: A, B, C, M, N, S, U	<b>RTA 1</b>											
 <b>Mesh MB Knee - Tilter</b> COM Yardage: 1 Freight Class: 150 Product Weight (lbs.): 50 Cubic Feet Per Carton: 10.75	 <b>ADJUSTMENTS</b> (1) Tilt tension (2) Pneumatic seat height (9) Chair tilt lock (5B) Knee-tilt action	2677-2	1222	1248	1268	1299	1342	1358	1395	1468	1503	1570	1662	1776
		2677LM-2	-	-	-	-	1347	-	-	1480	1520	1587	1687	1807
		Leather/Mock Leather			<b>OVERALL DIMENSIONS</b>			<b>SEAT DIMENSIONS</b>			<b>BACK DIMENSIONS</b>			
			<b>W</b>	<b>D</b>	<b>H</b>	<b>W</b>	<b>D</b>	<b>H</b>	<b>W</b>	<b>H</b>				
	25	25	37	20	19	18-22	18.5	18						
		Ergonomic Features: A, B, C, J, M, N, U	<b>RTA 1</b>											

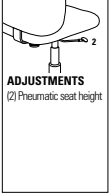

DESCRIPTION	FEATURES	MODEL#	STANDARD TEXTILE GRADES											
			1	2	3	4	5	6	7	8	9	10	11	12
 <p><b>Mesh MB Tilter</b> COM Yardage: 1 Freight Class: 250 Product Weight (lbs.): 40 Cubic Feet Per Carton: 10.75</p>	 <p><b>ADJUSTMENTS</b> (1) Tilt tension (2) Pneumatic seat height (3) Chair tilt lock (5A) Center-tilt action</p>													
		<b>2677-4</b>	1014	1041	1061	1091	1135	1151	1188	1261	1296	1362	1454	1569
		<b>2677LM-4</b>	-	-	-	-	1144	-	-	1278	1317	1383	1484	1604
		Leather/Mock Leather												
		<b>OVERALL DIMENSIONS</b>			<b>SEAT DIMENSIONS</b>			<b>BACK DIMENSIONS</b>						
<b>W</b>	<b>D</b>	<b>H</b>	<b>W</b>	<b>D</b>	<b>H</b>	<b>W</b>	<b>D</b>	<b>H</b>	<b>W</b>	<b>D</b>	<b>H</b>	<b>W</b>	<b>H</b>	
25	25	37	20	19	16-20	18.5	18							
			<b>RTA 1</b>											
 <p><b>Mesh MB Stool</b> COM Yardage: 1 Freight Class: 150 Product Weight (lbs.): 48 Cubic Feet Per Carton: 10.75</p>	 <p><b>ADJUSTMENTS</b> (2) Pneumatic seat height</p>													
		<b>2678-6</b>	1214	1241	1261	1291	1334	1351	1388	1461	1496	1562	1654	1769
		<b>2678LM-6</b>	-	-	-	-	1334	-	-	1468	1507	1575	1676	1795
		Leather/Mock Leather												
		<b>OVERALL DIMENSIONS</b>			<b>SEAT DIMENSIONS</b>			<b>BACK DIMENSIONS</b>						
<b>W</b>	<b>D</b>	<b>H</b>	<b>W</b>	<b>D</b>	<b>H</b>	<b>W</b>	<b>D</b>	<b>H</b>	<b>W</b>	<b>D</b>	<b>H</b>	<b>W</b>	<b>H</b>	
25	26	47	20	19	23.5-33.5	18.5	18							
			<b>RTA 1</b>											

GOAL™



model 2237-3



model 2239-6

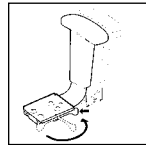

**Vari-Width Adapter Plate (WA)**







Available when chair is ordered with adjustable height arms.



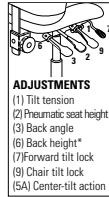

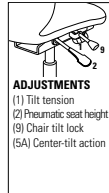

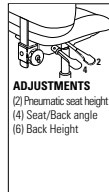

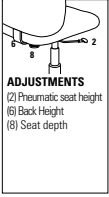

**STANDARD FEATURES**

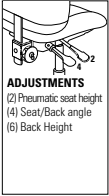
- Designed with substantial upholstery and cushioning treatment.
- Standard with adjustable height T-arms with curved urethane armcaps (3N) in Black only.
- All models are standard with a five-legged, injection molded “spider” base and C65 casters
- Base and frame available in Black (BK) only.
- Not available in Leather. Available in Global fabrics except Crescent and Silhouette.
- Vari-Width Adapter Plate (WA) allows each arm to move outward an additional 2”. Add \$62. Also height adjustable.

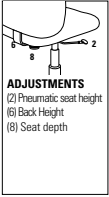
**OPTIONAL FEATURES**

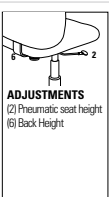
- Please refer to “Arms Selection” section of the price book for arm options.
- Optional ballistic nylon outer back fabric available. Resistant to impact damage. Available in Black Only (BKB). Add \$15.
- Available with back edge vinyl bumper guard option (VBG). Add \$18.
- Please refer to the “Casters Selection” section of the price book for caster options. Optional casters may be priced higher than the standard casters for your chair and the difference will be charged. Lower priced optional casters will not be credited.
- For hard surface flooring casters, specify C65R. Add \$51.
- For fully assembled in box, please specify SU. Add \$55.

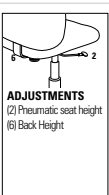
DESCRIPTION	FEATURES	MODEL#	STANDARD TEXTILE GRADES																								
			1	2	3	4	5	6	7	8	9	10	11	12													
 <p><b>LB Multi - Tilter</b> COM Yardage: 1.50 Freight Class: 150 Product Weight (lbs.): 53 Cubic Feet Per Carton: 9.25</p>	 <p><b>ADJUSTMENTS</b> (1) Tilt tension (2) Pneumatic seat height (3) Back angle (6) Back height* (7) Forward tilt lock (9) Chair tilt lock (5A) Center-tilt action</p>	<p>Ergonomic Features: A, B, C, D, F, G, H, N, S</p>	<table border="1"> <tr> <td>2237-3</td> <td>562</td> <td>600</td> <td>633</td> <td>680</td> <td>746</td> <td>772</td> <td>830</td> <td>943</td> <td>997</td> <td>1100</td> <td>1241</td> <td>1418</td> </tr> </table>												2237-3	562	600	633	680	746	772	830	943	997	1100	1241	1418
			2237-3	562	600	633	680	746	772	830	943	997	1100	1241	1418												
			<p><b>OVERALL DIMENSIONS</b></p> <table border="1"> <tr> <th>W</th> <th>D</th> <th>H</th> </tr> <tr> <td>25</td> <td>22.5</td> <td>36</td> </tr> </table>			W	D	H	25	22.5	36	<p><b>SEAT DIMENSIONS</b></p> <table border="1"> <tr> <th>W</th> <th>D</th> <th>H</th> </tr> <tr> <td>20</td> <td>17</td> <td>16.5-20.5</td> </tr> </table>			W	D	H	20	17	16.5-20.5	<p><b>BACK DIMENSIONS</b></p> <table border="1"> <tr> <th>W</th> <th>H</th> </tr> <tr> <td>18.5</td> <td>18-21</td> </tr> </table>			W	H	18.5	18-21
W	D	H																									
25	22.5	36																									
W	D	H																									
20	17	16.5-20.5																									
W	H																										
18.5	18-21																										
<p>RTA 2 </p>																											
 <p><b>LB Tilter</b> COM Yardage: 1.50 Freight Class: 150 Product Weight (lbs.): 43 Cubic Feet Per Carton: 9.75</p>	 <p><b>ADJUSTMENTS</b> (1) Tilt tension (2) Pneumatic seat height (9) Chair tilt lock (5A) Center-tilt action</p>	<p>Ergonomic Features: A, B, C, H, N, S</p>	<table border="1"> <tr> <td>2237-4</td> <td>486</td> <td>525</td> <td>558</td> <td>604</td> <td>670</td> <td>695</td> <td>754</td> <td>867</td> <td>920</td> <td>1023</td> <td>1164</td> <td>1341</td> </tr> </table>												2237-4	486	525	558	604	670	695	754	867	920	1023	1164	1341
			2237-4	486	525	558	604	670	695	754	867	920	1023	1164	1341												
			<p><b>OVERALL DIMENSIONS</b></p> <table border="1"> <tr> <th>W</th> <th>D</th> <th>H</th> </tr> <tr> <td>25</td> <td>25</td> <td>36.5</td> </tr> </table>			W	D	H	25	25	36.5	<p><b>SEAT DIMENSIONS</b></p> <table border="1"> <tr> <th>W</th> <th>D</th> <th>H</th> </tr> <tr> <td>20</td> <td>17</td> <td>15.5-20.5</td> </tr> </table>			W	D	H	20	17	15.5-20.5	<p><b>BACK DIMENSIONS</b></p> <table border="1"> <tr> <th>W</th> <th>H</th> </tr> <tr> <td>18.5</td> <td>19</td> </tr> </table>			W	H	18.5	19
W	D	H																									
25	25	36.5																									
W	D	H																									
20	17	15.5-20.5																									
W	H																										
18.5	19																										
<p>RTA 2 </p>																											
 <p><b>LB Operator w/ Arms</b> COM Yardage: 1.50 Freight Class: 125 Product Weight (lbs.): 44 Cubic Feet Per Carton: 6.25</p>	 <p><b>ADJUSTMENTS</b> (2) Pneumatic seat height (4) Seat/Back angle (6) Back Height</p>	<p>Ergonomic Features: C, D, F, G, H, N</p>	<table border="1"> <tr> <td>2237-5</td> <td>442</td> <td>483</td> <td>514</td> <td>562</td> <td>627</td> <td>651</td> <td>710</td> <td>823</td> <td>877</td> <td>979</td> <td>1121</td> <td>1298</td> </tr> </table>												2237-5	442	483	514	562	627	651	710	823	877	979	1121	1298
			2237-5	442	483	514	562	627	651	710	823	877	979	1121	1298												
			<p><b>OVERALL DIMENSIONS</b></p> <table border="1"> <tr> <th>W</th> <th>D</th> <th>H</th> </tr> <tr> <td>25</td> <td>22.5</td> <td>36</td> </tr> </table>			W	D	H	25	22.5	36	<p><b>SEAT DIMENSIONS</b></p> <table border="1"> <tr> <th>W</th> <th>D</th> <th>H</th> </tr> <tr> <td>20</td> <td>17</td> <td>15.5-20.5</td> </tr> </table>			W	D	H	20	17	15.5-20.5	<p><b>BACK DIMENSIONS</b></p> <table border="1"> <tr> <th>W</th> <th>H</th> </tr> <tr> <td>18.5</td> <td>18-21</td> </tr> </table>			W	H	18.5	18-21
W	D	H																									
25	22.5	36																									
W	D	H																									
20	17	15.5-20.5																									
W	H																										
18.5	18-21																										
<p>RTA 2 </p>																											

DESCRIPTION	FEATURES	MODEL#	STANDARD TEXTILE GRADES													
			1	2	3	4	5	6	7	8	9	10	11	12		
 <p><b>LB Task w/ Arms</b> COM Yardage: 1.50 Freight Class: 125 Product Weight (lbs.): 36 Cubic Feet Per Carton: 5.75</p>	 <p><b>ADJUSTMENTS</b> (2) Pneumatic seat height (6) Back Height (8) Seat depth</p>	<b>2237-6</b>	368	409	441	488	555	576	637	749	803	906	1048	1226		
			<b>OVERALL DIMENSIONS</b>			<b>SEAT DIMENSIONS</b>			<b>BACK DIMENSIONS</b>							
			<b>W</b>	<b>D</b>	<b>H</b>	<b>W</b>	<b>D</b>	<b>H</b>	<b>W</b>	<b>H</b>						
			25	24.5	39	20	17-18.5	15.5-20.5	18.5	20.5-22						
			<b>RTA 2</b>													
 <p><b>LB Operator Armless</b> COM Yardage: 1.50 Freight Class: 125 Product Weight (lbs.): 30 Cubic Feet Per Carton: 4.90</p>	 <p><b>ADJUSTMENTS</b> (2) Pneumatic seat height (4) Seat/Back angle (6) Back Height</p>	<b>2239-5</b>	368	409	441	488	555	576	637	749	803	906	1048	1226		
			<b>OVERALL DIMENSIONS</b>			<b>SEAT DIMENSIONS</b>			<b>BACK DIMENSIONS</b>							
			<b>W</b>	<b>D</b>	<b>H</b>	<b>W</b>	<b>D</b>	<b>H</b>	<b>W</b>	<b>H</b>						
			20.5	22.5	36	20	17	15.5-20.5	18.5	18-21						
			<b>RTA 2</b>													
 <p><b>LB Task Armless</b> COM Yardage: 1.50 Freight Class: 125 Product Weight (lbs.): 30 Cubic Feet Per Carton: 4.90</p>	 <p><b>ADJUSTMENTS</b> (2) Pneumatic seat height (6) Back Height (8) Seat depth</p>	<b>2239-6</b>	284	324	356	402	469	494	553	665	717	822	963	1140		
			<b>OVERALL DIMENSIONS</b>			<b>SEAT DIMENSIONS</b>			<b>BACK DIMENSIONS</b>							
			<b>W</b>	<b>D</b>	<b>H</b>	<b>W</b>	<b>D</b>	<b>H</b>	<b>W</b>	<b>H</b>						
			20.5	24.5	39	20	17-18.5	15.5-20.5	18.5	20.5-22						
			<b>RTA 2</b>													
 <p><b>Drafting Task Chair w/ Arms</b> COM Yardage: 1.50 Freight Class: 125 Product Weight (lbs.): 44 Cubic Feet Per Carton: 6.75</p>	 <p><b>ADJUSTMENTS</b> (2) Pneumatic seat height (6) Back Height</p>	<b>2235-6</b>	479	520	553	599	666	691	749	862	916	1019	1159	1337		
			<b>OVERALL DIMENSIONS</b>			<b>SEAT DIMENSIONS</b>			<b>BACK DIMENSIONS</b>							
			<b>W</b>	<b>D</b>	<b>H</b>	<b>W</b>	<b>D</b>	<b>H</b>	<b>W</b>	<b>H</b>						
			25	24.5	48	20	17	23.5-33.5	18.5	20.5-22						
			<b>RTA 2</b>													
 <p><b>Drafting Task Chair Armless</b> COM Yardage: 1.50 Freight Class: 150 Product Weight (lbs.): 36 Cubic Feet Per Carton: 6.75</p>	 <p><b>ADJUSTMENTS</b> (2) Pneumatic seat height (6) Back Height</p>	<b>2236-6</b>	421	461	492	540	605	630	689	801	853	957	1100	1278		
			<b>OVERALL DIMENSIONS</b>			<b>SEAT DIMENSIONS</b>			<b>BACK DIMENSIONS</b>							
			<b>W</b>	<b>D</b>	<b>H</b>	<b>W</b>	<b>D</b>	<b>H</b>	<b>W</b>	<b>H</b>						
			20.5	24.5	48	20	17	23.5-33.5	18.5	20.5-22						
			<b>RTA 2</b>													

GRAHAM™



model 3144 (3N)

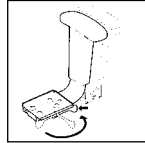

**Vari-Width Adapter Plate (WA)**  
Available when chair is ordered with adjustable height arms.

STANDARD FEATURES

- Features a multi-curved backrest with an impact resistant outer back shell.
- Standard with adjustable height T-arms with curved urethane armcaps (3N) in Black Only.
- All models are standard with a five-legged, injection molded "spider" base and C10 casters
- Base and frame available in Black (BK) Only.
- Not available in Leather.
- Vari-Width Adapter Plate (WA) allows each arm to move outward an additional 2". Specify "WA". Add \$62 also height adjustable.

OPTIONAL FEATURES

- Please refer to "Arms Selection" section of the price book for arm options.
- Optional ballistic nylon outer back fabric available. Resistant to impact damage. Available in Black Only (BKB). Add \$14.
- Please refer to the "Casters Selection" section of the price book for caster options. Optional casters may be priced higher than the standard casters for your chair and the difference will be charged. Lower priced optional casters will not be credited.
- For hard surface flooring casters, specify C10R. Add \$46.
- For fully assembled in box, please specify SU. Add \$55.

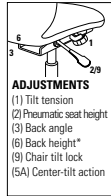
DESCRIPTION	FEATURES	MODEL#	STANDARD TEXTILE GRADES											
			1	2	3	4	5	6	7	8	9	10	11	12
 <p><b>LB Ergo - Tilter</b> COM Yardage: 1.50 Freight Class: 150 Product Weight (lbs.): 50 Cubic Feet Per Carton: 9.25</p>	 <p><b>ADJUSTMENTS</b> (1) Tilt tension (2) Pneumatic seat height (3) Back angle (6) Back height* (9) Chair tilt lock (5A) Center-tilt action</p>	3144	561	599	631	679	744	771	829	942	995	1097	1240	1417
			OVERALL DIMENSIONS			SEAT DIMENSIONS			BACK DIMENSIONS					
			W	D	H	W	D	H	W	H				
			25	26	37.5	20	19.5	17-21	19.5	17.5-20				
			RTA 2		ups									

Ergonomic Features:  
A, B, C, D, G, H, M, N, S

GRANADA®



model 3212 (3N)



model 3212 (3N)

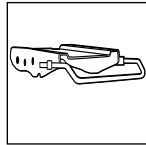

**Multi-Depth Mechanism**  
Seat depth option is available on multi-tilter models. (see notes for more details)



model 3217









model 3217

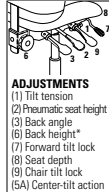

STANDARD FEATURES

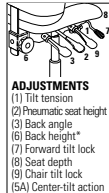

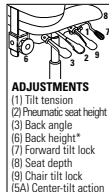
- Features a sculpted back with pronounced lumbar support.
- Standard with adjustable height T-arms with curved urethane armcaps (3N) in Black Only. (except for model 3262 which has a fixed height version of this same arm style.)
- Standard when chair is ordered with adjustable height arms (AA, O, OJ, SB, TD, UB, ZH, ZT, 3M, 3N, 4J, 4M, 4T, 6L, 9B and 9S). Allows each arm to move outward an additional 2" (for a total of 4" extra seat width) and locks with the use of an easy to maneuver lever.
- All models (except armchair and side chair styles) are standard with a five-legged, injection molded base.
- Base and frame are available in Black (BK) Only.
- All models (except high back, side chair, armchair and drafting models) are shipped partially KD.
- Drafting chairs are equipped with height adjustable chrome foot ring.
- C65 casters are standard except for heavy duty models.
- Not available in Leather.

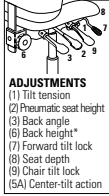

OPTIONAL FEATURES

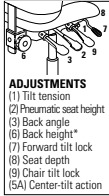

- Available in Memory Foam. Use code "MF" and Add \$84.
- Available with back edge vinyl bumper guard option (VBG). Add \$18.
- Please refer to "Arms Selection" section of the price book for arm options.
- Optional ballistic nylon outer back fabric available (the back panel will be attached with washer head screws). Resistant to impact damage. Available in Black Only (BKB). Add \$14
- For hard surface flooring please specify C10R. Add \$46.
- Please refer to the "Casters Selection" section of the price book for caster options. Optional casters may be priced higher than the standard casters for your chair and the difference will be charged. Lower priced optional casters will not be credited.
- For availability of chair series in Vinyl, please contact a Global Sales Representative.
- For fully assembled in box, please specify SU. Add \$55.



DESCRIPTION	FEATURES	MODEL#	STANDARD TEXTILE GRADES												
			1	2	3	4	5	6	7	8	9	10	11	12	
 <p><b>LB Multi - Tilter</b> Plain Back Ratchet Back COM Yardage: 1.50 Freight Class: 150 Product Weight (lbs.): 52 Cubic Feet Per Carton: 9.25</p>	 <p><b>ADJUSTMENTS</b> (1) Tilt tension (2) Pneumatic seat height (3) Back angle (6) Back height* (7) Forward tilt lock (8) Seat depth (9) Chair tilt lock (SA) Center-tilt action</p>	<p>Ergonomic Features: A, B, C, D, E, F, G, M, N, S</p>	3121	1030	1070	1101	1146	1211	1234	1291	1400	1452	1554	1690	1862
			<b>OVERALL DIMENSIONS</b>			<b>SEAT DIMENSIONS</b>			<b>BACK DIMENSIONS</b>						
			<b>W</b>	<b>D</b>	<b>H</b>	<b>W</b>	<b>D</b>	<b>H</b>	<b>W</b>		<b>H</b>				
			26	24.5	40	20.5	16.5	17-21	19		17.5-20.5				
			RTA 2												
 <p><b>HB Multi - Tilter</b> Plain Back Ratchet Back COM Yardage: 1.75 Freight Class: 150 Product Weight (lbs.): 55 Cubic Feet Per Carton: 9.25</p>	 <p><b>ADJUSTMENTS</b> (1) Tilt tension (2) Pneumatic seat height (3) Back angle (6) Back height* (7) Forward tilt lock (8) Seat depth (9) Chair tilt lock (SA) Center-tilt action</p>	<p>Ergonomic Features: A, B, C, D, E, F, G, H, M, N, O, S</p>	3123	1137	1192	1234	1306	1400	1417	1494	1681	1716	1904	2043	2277
			<b>OVERALL DIMENSIONS</b>			<b>SEAT DIMENSIONS</b>			<b>BACK DIMENSIONS</b>						
			<b>W</b>	<b>D</b>	<b>H</b>	<b>W</b>	<b>D</b>	<b>H</b>	<b>W</b>		<b>H</b>				
			26	24.5	43	20.5	17-19.5	17-21	19		22-25				
			RTA 2												
 <p><b>LB Multi - Tilter</b> Detailed/Styled Back COM Yardage: 1.50 Freight Class: 150 Product Weight (lbs.): 52 Cubic Feet Per Carton: 9.25</p>	 <p><b>ADJUSTMENTS</b> (1) Tilt tension (2) Pneumatic seat height (3) Back angle (6) Back height* (7) Forward tilt lock (8) Seat depth (9) Chair tilt lock (SA) Center-tilt action</p>	<p>Ergonomic Features: A, B, C, D, E, F, G, M, N, S</p>	3202	850	891	922	971	1036	1061	1120	1231	1285	1389	1529	1707
			<b>OVERALL DIMENSIONS</b>			<b>SEAT DIMENSIONS</b>			<b>BACK DIMENSIONS</b>						
			<b>W</b>	<b>D</b>	<b>H</b>	<b>W</b>	<b>D</b>	<b>H</b>	<b>W</b>		<b>H</b>				
			26	22.5	40	19	16.5	18-22	18.5		21				
			RTA 2												



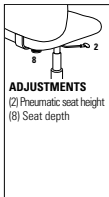



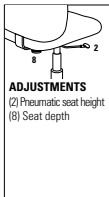

DESCRIPTION	FEATURES	MODEL#	STANDARD TEXTILE GRADES													
			1	2	3	4	5	6	7	8	9	10	11	12		
 <p><b>LB Multi - Tilter</b> Plain Back COM Yardage: 1.50 Freight Class: 125 Product Weight (lbs.): 58 Cubic Feet Per Carton: 9.25</p>	 <p><b>ADJUSTMENTS</b> (1) Tilt tension (2) Pneumatic seat height (3) Back angle (6) Back height* (7) Forward tilt lock (8) Seat depth (9) Chair tilt lock (5A) Center-tilt action</p>	<p><b>Ergonomic Features:</b> A, B, C, D, E, F, G, H, M, N, Q, S</p>	3212	754	795	826	874	941	967	1023	1137	1189	1291	1432	1610	
			<b>OVERALL DIMENSIONS</b>			<b>SEAT DIMENSIONS</b>			<b>BACK DIMENSIONS</b>							
			<b>W</b>	<b>D</b>	<b>H</b>	<b>W</b>	<b>D</b>	<b>H</b>	<b>W</b>	<b>H</b>						
			26	24	40	19	16.5	18-22	18.5	21						
			<b>RTA 2</b>													



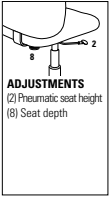

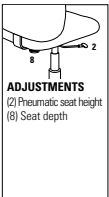

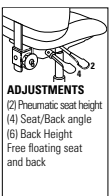

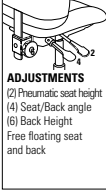

 <p><b>HB Multi - Tilter</b> Plain Back COM Yardage: 1.75 Freight Class: 150 Product Weight (lbs.): 57 Cubic Feet Per Carton: 10.50</p>	 <p><b>ADJUSTMENTS</b> (1) Tilt tension (2) Pneumatic seat height (3) Back angle (6) Back height* (7) Forward tilt lock (8) Seat depth (9) Chair tilt lock (5A) Center-tilt action</p>	<p><b>Ergonomic Features:</b> A, B, C, D, E, F, G, H, M, N, Q, S</p>	3217	847	894	929	986	1063	1090	1159	1290	1353	1476	1640	1844	
			<b>OVERALL DIMENSIONS</b>			<b>SEAT DIMENSIONS</b>			<b>BACK DIMENSIONS</b>							
			<b>W</b>	<b>D</b>	<b>H</b>	<b>W</b>	<b>D</b>	<b>H</b>	<b>W</b>	<b>H</b>						
			26	24.5	43	19	17.5	18-22	18.5	26						
			<b>RTA 2</b>													

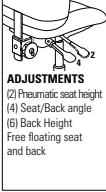
 <p><b>Side Chair</b> Plain Back COM Yardage: 1.50 Freight Class: 300 Product Weight (lbs.): 32 Cubic Feet Per Carton: 17.25</p>	 <p><b>ADJUSTMENTS</b> (2) Pneumatic seat height (8) Seat depth</p>	<p><b>Ergonomic Features:</b> M, N</p>	3253	606	647	679	727	793	818	877	989	1044	1145	1287	1463	
			<b>OVERALL DIMENSIONS</b>			<b>SEAT DIMENSIONS</b>			<b>BACK DIMENSIONS</b>							
			<b>W</b>	<b>D</b>	<b>H</b>	<b>W</b>	<b>D</b>	<b>H</b>	<b>W</b>	<b>H</b>						
			20.5	23.5	37.5	19	16.5	19	18.5	21						
			<b>RTA 00</b>													

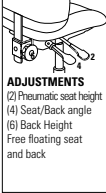

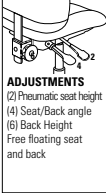
 <p><b>LB Task</b> Armless/Plain Back COM Yardage: 1.50 Freight Class: 250 Product Weight (lbs.): 32 Cubic Feet Per Carton: 9.25</p>	 <p><b>ADJUSTMENTS</b> (2) Pneumatic seat height (8) Seat depth</p>	<p><b>Ergonomic Features:</b> C, E, M, N</p>	3254	486	525	558	604	670	695	754	867	920	1023	1164	1341	
			<b>OVERALL DIMENSIONS</b>			<b>SEAT DIMENSIONS</b>			<b>BACK DIMENSIONS</b>							
			<b>W</b>	<b>D</b>	<b>H</b>	<b>W</b>	<b>D</b>	<b>H</b>	<b>W</b>	<b>H</b>						
			21	24	38	19	16.5	17-22	18.5	21						
			<b>RTA 1</b>													

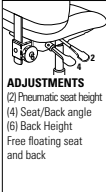
 <p><b>LB Task</b> w/Arm/Plain Back COM Yardage: 1.50 Freight Class: 150 Product Weight (lbs.): 40 Cubic Feet Per Carton: 9.25</p>	 <p><b>ADJUSTMENTS</b> (2) Pneumatic seat height (8) Seat depth</p>	<p><b>Ergonomic Features:</b> C, E, H, M, N, Q</p>	3255	614	652	684	732	799	823	881	995	1048	1151	1291	1469	
			<b>OVERALL DIMENSIONS</b>			<b>SEAT DIMENSIONS</b>			<b>BACK DIMENSIONS</b>							
			<b>W</b>	<b>D</b>	<b>H</b>	<b>W</b>	<b>D</b>	<b>H</b>	<b>W</b>	<b>H</b>						
			26	24	38	19	16.5	17-22	18.5	21						
			<b>RTA 1</b>													

DESCRIPTION	FEATURES	MODEL#	STANDARD TEXTILE GRADES														
			1	2	3	4	5	6	7	8	9	10	11	12			
 <b>Armchair</b> Detailed/Styled Back COM Yardage: 1.50 Freight Class: 250 Product Weight (lbs.): 40 Cubic Feet Per Carton: 17	Ergonomic Features: M, N RTA 00	3262	798	836	870	917	981	1006	1066	1179	1231	1335	1478	1654			
		<b>OVERALL DIMENSIONS</b>			<b>SEAT DIMENSIONS</b>			<b>BACK DIMENSIONS</b>									
		<b>W</b>	<b>D</b>	<b>H</b>	<b>W</b>	<b>D</b>	<b>H</b>	<b>W</b>	<b>H</b>								
	26	23.5	37.5	19	16.5	19	18.5	21									
 <b>Side Chair</b> Detailed/Styled Back COM Yardage: 1.50 Freight Class: 300 Product Weight (lbs.): 32 Cubic Feet Per Carton: 17.25	Ergonomic Features: M, N RTA 00	3263	645	684	716	764	830	853	914	1026	1079	1182	1324	1501			
		<b>OVERALL DIMENSIONS</b>			<b>SEAT DIMENSIONS</b>			<b>BACK DIMENSIONS</b>									
		<b>W</b>	<b>D</b>	<b>H</b>	<b>W</b>	<b>D</b>	<b>H</b>	<b>W</b>	<b>H</b>								
	20.5	23.5	37.5	19	16.5	19	18.5	21									
 <b>LB Task</b> Armless/Detailed/Styled Back COM Yardage: 1.50 Freight Class: 250 Product Weight (lbs.): 32 Cubic Feet Per Carton: 9.25	 <b>ADJUSTMENTS</b> (Z) Pneumatic seat height (B) Seat depth	Ergonomic Features: C, E, M, N RTA 2	3264	515	556	589	634	701	726	785	897	950	1052	1195	1372		
			<b>OVERALL DIMENSIONS</b>			<b>SEAT DIMENSIONS</b>			<b>BACK DIMENSIONS</b>								
			<b>W</b>	<b>D</b>	<b>H</b>	<b>W</b>	<b>D</b>	<b>H</b>	<b>W</b>	<b>H</b>							
	21	23.5	39	19	16.5	17-22	18.5	21									
 <b>LB Task</b> w/Arm/Detailed/Styled Back COM Yardage: 1.50 Freight Class: 150 Product Weight (lbs.): 40 Cubic Feet Per Carton: 9.25	 <b>ADJUSTMENTS</b> (Z) Pneumatic seat height (B) Seat depth	Ergonomic Features: C, E, H, M, N, Q RTA 2 	3265	645	684	716	764	830	853	914	1026	1079	1182	1324	1501		
			<b>OVERALL DIMENSIONS</b>			<b>SEAT DIMENSIONS</b>			<b>BACK DIMENSIONS</b>								
			<b>W</b>	<b>D</b>	<b>H</b>	<b>W</b>	<b>D</b>	<b>H</b>	<b>W</b>	<b>H</b>							
	26	23.5	39	19	16.5	17-22	18.5	21									
 <b>LB Operator</b> w/Arm/Plain Back COM Yardage: 1.50 Freight Class: 150 Product Weight (lbs.): 46 Cubic Feet Per Carton: 9.25	 <b>ADJUSTMENTS</b> (Z) Pneumatic seat height (A) Seat/Back angle (B) Back Height Free floating seat and back	Ergonomic Features: C, D, F, G, H, M, N, Q, S RTA 2 	3275	730	771	801	849	916	941	999	1112	1164	1266	1409	1586		
			<b>OVERALL DIMENSIONS</b>			<b>SEAT DIMENSIONS</b>			<b>BACK DIMENSIONS</b>								
			<b>W</b>	<b>D</b>	<b>H</b>	<b>W</b>	<b>D</b>	<b>H</b>	<b>W</b>	<b>H</b>							
	26	22.5	39	19	16.5	17-22	18.5	21									

DESCRIPTION	FEATURES	MODEL#	STANDARD TEXTILE GRADES													
			1	2	3	4	5	6	7	8	9	10	11	12		
 <p><b>Drafting Chair</b> Armless/Detailed/Styled Back COM Yardage: 1.50 Freight Class: 150 Product Weight (lbs.): 43 Cubic Feet Per Carton: 9.25</p>	 <p><b>ADJUSTMENTS</b> (2) Pneumatic seat height (4) Seat/Back angle (6) Back Height Free floating seat and back</p>	<p><b>3277</b></p>	1062	1103	1135	1181	1248	1274	1332	1444	1497	1600	1742	1918		
			<b>OVERALL DIMENSIONS</b>			<b>SEAT DIMENSIONS</b>			<b>BACK DIMENSIONS</b>							
			<b>W</b>	<b>D</b>	<b>H</b>	<b>W</b>	<b>D</b>	<b>H</b>	<b>W</b>	<b>H</b>						
			21	22.5	48	19	16.5	24-34	18.5	21						
<p>Ergonomic Features: C, D, F, G, H, M, N</p>																
 <p><b>Drafting Stool</b> Armless/Plain Back COM Yardage: 1.50 Freight Class: 150 Product Weight (lbs.): 43 Cubic Feet Per Carton: 9.25</p>	 <p><b>ADJUSTMENTS</b> (2) Pneumatic seat height (4) Seat/Back angle (6) Back Height Free floating seat and back</p>	<p><b>3278</b></p>	1021	1061	1092	1140	1206	1230	1289	1401	1455	1558	1699	1879		
			<b>OVERALL DIMENSIONS</b>			<b>SEAT DIMENSIONS</b>			<b>BACK DIMENSIONS</b>							
			<b>W</b>	<b>D</b>	<b>H</b>	<b>W</b>	<b>D</b>	<b>H</b>	<b>W</b>	<b>H</b>						
			21	23.5	48	19	16.5	24-34	18.5	21						
<p>Ergonomic Features: C, D, F, G, H, M, N</p>		<p>RTA 2</p>														
 <p><b>LB Operator</b> Armless Detailed/Styled Back COM Yardage: 1.50 Freight Class: 150 Product Weight (lbs.): 40 Cubic Feet Per Carton: 9.25</p>	 <p><b>ADJUSTMENTS</b> (2) Pneumatic seat height (4) Seat/Back angle (6) Back Height Free floating seat and back</p>	<p><b>3284</b></p>	633	675	705	752	819	845	903	1016	1068	1172	1313	1490		
			<b>OVERALL DIMENSIONS</b>			<b>SEAT DIMENSIONS</b>			<b>BACK DIMENSIONS</b>							
			<b>W</b>	<b>D</b>	<b>H</b>	<b>W</b>	<b>D</b>	<b>H</b>	<b>W</b>	<b>H</b>						
			21	22.5	39	20.5	16.5	17-22	19	21						
<p>Ergonomic Features: C, D, F, G, M, N</p>		<p>RTA 2</p>														
 <p><b>LB Operator</b> w/Arms/Detailed/Styled Back COM Yardage: 1.50 Freight Class: 150 Product Weight (lbs.): 46 Cubic Feet Per Carton: 9.25</p>	 <p><b>ADJUSTMENTS</b> (2) Pneumatic seat height (4) Seat/Back angle (6) Back Height Free floating seat and back</p>	<p><b>3285</b></p>	761	801	832	880	946	972	1029	1142	1196	1300	1441	1619		
			<b>OVERALL DIMENSIONS</b>			<b>SEAT DIMENSIONS</b>			<b>BACK DIMENSIONS</b>							
			<b>W</b>	<b>D</b>	<b>H</b>	<b>W</b>	<b>D</b>	<b>H</b>	<b>W</b>	<b>H</b>						
			26	22.5	39	19	16.5	17-22	18.5	21						
<p>Ergonomic Features: C, D, F, G, H, M, N, Q</p>		<p>RTA 2</p>														
 <p><b>Drafting Stool</b> w/Arms/Detailed/Styled Back COM Yardage: 1.50 Freight Class: 150 Product Weight (lbs.): 51 Cubic Feet Per Carton: 9.25</p>	 <p><b>ADJUSTMENTS</b> (2) Pneumatic seat height (4) Seat/Back angle (6) Back Height Free floating seat and back</p>	<p><b>3287</b></p>	1210	1251	1282	1331	1397	1423	1480	1593	1644	1747	1888	2068		
			<b>OVERALL DIMENSIONS</b>			<b>SEAT DIMENSIONS</b>			<b>BACK DIMENSIONS</b>							
			<b>W</b>	<b>D</b>	<b>H</b>	<b>W</b>	<b>D</b>	<b>H</b>	<b>W</b>	<b>H</b>						
			26	22.5	48	19	16.5	24-34	18.5	21						
<p>Ergonomic Features: C, D, F, G, H, M, N, Q</p>		<p>RTA 2</p>														

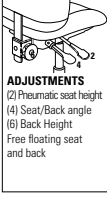

DESCRIPTION	FEATURES	MODEL#	STANDARD TEXTILE GRADES														
			1	2	3	4	5	6	7	8	9	10	11	12			
 <p><b>Drafting Stool</b> w/Arms/Plain Back COM Yardage: 1.50 Freight Class: 150 Product Weight (lbs.): 51 Cubic Feet Per Carton: 9.25</p>	 <p><b>ADJUSTMENTS</b> (2) Pneumatic seat height (4) Seat/Back angle (6) Back Height Free floating seat and back</p>	<b>3288</b>	1172	1212	1245	1290	1356	1381	1441	1553	1606	1710	1851	2028			
			OVERALL DIMENSIONS			SEAT DIMENSIONS			BACK DIMENSIONS								
			W	D	H	W	D	H	W	H							
26	23.5	48	19	16.5	24-34	18.5	21										
		Ergonomic Features: C, D, F, G, H, M, N, Q	RTA 2														

## GRANADA® DELUXE



model 1170-3







model 1171-3





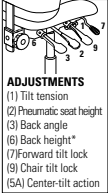

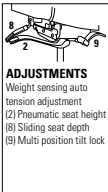

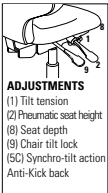

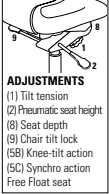
### STANDARD FEATURES

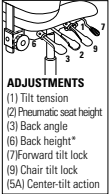

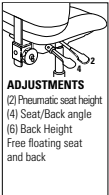

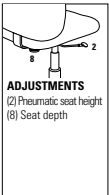
- Granada Deluxe offers dramatic seating comfort with a more contoured seat.
- Standard with height and width adjustable height T-arms with teardrop shaped urethane armcaps (3B).
- All models except the armchair and sidechair are standard with a five legged, injection molded reinforced nylon spider base with C65 casters.
- Base and frames are standard in Black (BK).

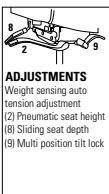



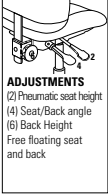

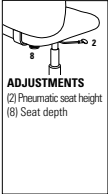

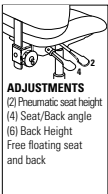

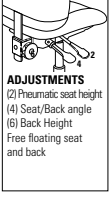
### OPTIONAL FEATURES

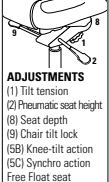
- Seat depth is optional on model 1171-2. Please specify (MD) Add \$91
- Optional ballistic nylon outer back fabric available, resistant to impact damage. Black Only (BKB), add \$14.
- Available with back edge vinyl bumper guard option (VBG).
- Available in Memory Foam (MF), add \$84.
- Polished Aluminum base with black scuff tips. Specify "B2". Add \$117.
- For hard surface flooring casters, specify C65R. Add \$51.
- For fully assembled in box, please specify SU. Add \$55.
- Please refer to "Arms Selection" section of the price book for arm options.
- Please refer to "Cylinder Selection" section of the price book for additional cylinder options.

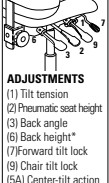
DESCRIPTION	FEATURES	MODEL#	STANDARD TEXTILE GRADES																								
			1	2	3	4	5	6	7	8	9	10	11	12													
 <p><b>HB Multi - Tilter</b> COM Yardage: 2 Freight Class: 125 Product Weight (lbs.): 65 Cubic Feet Per Carton: 9.25</p>	 <p><b>ADJUSTMENTS</b> (1) Tilt tension (2) Pneumatic seat height (3) Back angle (6) Back height* (7) Forward tilt lock (9) Chair tilt lock (5A) Center-tilt action</p>	<p>Ergonomic Features: A, B, C, D, E, F, G, H, M, N, Q, S, U</p>	<table border="1"> <tr> <td>1170-3</td> <td>899</td> <td>946</td> <td>982</td> <td>1040</td> <td>1120</td> <td>1147</td> <td>1217</td> <td>1352</td> <td>1415</td> <td>1539</td> <td>1707</td> <td>1916</td> </tr> </table>												1170-3	899	946	982	1040	1120	1147	1217	1352	1415	1539	1707	1916
			1170-3	899	946	982	1040	1120	1147	1217	1352	1415	1539	1707	1916												
			<b>OVERALL DIMENSIONS</b>			<b>SEAT DIMENSIONS</b>			<b>BACK DIMENSIONS</b>																		
			<b>W</b>	<b>D</b>	<b>H</b>	<b>W</b>	<b>D</b>	<b>H</b>	<b>W</b>	<b>H</b>																	
26	23.5	45	21	18-20.5	16-20	20	23-28.25																				
		RTA 2		ups																							
 <p><b>HB Weight Sensing Synchro - Tilter</b> COM Yardage: 2 Freight Class: 125 Product Weight (lbs.): 61 Cubic Feet Per Carton: 9.25</p>	 <p><b>ADJUSTMENTS</b> Weight sensing auto tension adjustment (2) Pneumatic seat height (8) Sliding seat depth (9) Multi position tilt lock</p>	<p>Ergonomic Features: A, B, C, D, E, H, L, M, N, Q</p>	<table border="1"> <tr> <td>1170-8</td> <td>899</td> <td>946</td> <td>982</td> <td>1040</td> <td>1120</td> <td>1147</td> <td>1217</td> <td>1352</td> <td>1415</td> <td>1539</td> <td>1707</td> <td>1916</td> </tr> </table>												1170-8	899	946	982	1040	1120	1147	1217	1352	1415	1539	1707	1916
			1170-8	899	946	982	1040	1120	1147	1217	1352	1415	1539	1707	1916												
			<b>OVERALL DIMENSIONS</b>			<b>SEAT DIMENSIONS</b>			<b>BACK DIMENSIONS</b>																		
			<b>W</b>	<b>D</b>	<b>H</b>	<b>W</b>	<b>D</b>	<b>H</b>	<b>W</b>	<b>H</b>																	
26	23.5	44	21	18-20.5	16.5-20.5	20	23-28.2																				
		RTA 2		ups																							
 <p><b>HB Synchro - Tilter w/Back Angle Adjustment</b> COM Yardage: 1.75 Freight Class: 125 Product Weight (lbs.): 60 Cubic Feet Per Carton: 9.25</p>	 <p><b>ADJUSTMENTS</b> (1) Tilt tension (2) Pneumatic seat height (8) Seat depth (9) Chair tilt lock (5C) Synchro-tilt action Anti-Kick back</p>	<p>Ergonomic Features: A, B, C, D, E, G, H, L, M, N, Q</p>	<table border="1"> <tr> <td>1171-0</td> <td>806</td> <td>847</td> <td>879</td> <td>926</td> <td>997</td> <td>1021</td> <td>1080</td> <td>1194</td> <td>1250</td> <td>1355</td> <td>1500</td> <td>1679</td> </tr> </table>												1171-0	806	847	879	926	997	1021	1080	1194	1250	1355	1500	1679
			1171-0	806	847	879	926	997	1021	1080	1194	1250	1355	1500	1679												
			<b>OVERALL DIMENSIONS</b>			<b>SEAT DIMENSIONS</b>			<b>BACK DIMENSIONS</b>																		
			<b>W</b>	<b>D</b>	<b>H</b>	<b>W</b>	<b>D</b>	<b>H</b>	<b>W</b>	<b>H</b>																	
26	23.5	43	21	18-20.5	17.25-21.25	20	20-25.2																				
		RTA 2		ups																							

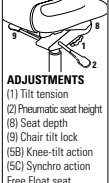
DESCRIPTION	FEATURES	MODEL#	STANDARD TEXTILE GRADES											
			1	2	3	4	5	6	7	8	9	10	11	12
 <p><b>MB Synchro Knee - Tilter</b> COM Yardage: 1.75 Freight Class: 125 Product Weight (lbs.): 61 Cubic Feet Per Carton: 9.25</p>	 <p><b>ADJUSTMENTS</b> (1) Tilt tension (2) Pneumatic seat height (6) Seat depth (9) Chair tilt lock (5B) Knee-tilt action (5C) Synchro action Free Float seat</p>	1171-2	917	955	989	1037	1106	1130	1190	1303	1358	1465	1609	1789
			<b>OVERALL DIMENSIONS</b>			<b>SEAT DIMENSIONS</b>			<b>BACK DIMENSIONS</b>					
			<b>W</b>	<b>D</b>	<b>H</b>	<b>W</b>	<b>D</b>	<b>H</b>	<b>W</b>	<b>H</b>				
			26	23.5	42.5	21	18-20.5	16-20	20	23-28.51				
	Ergonomic Features: A, B, C, D, G, J, H, L, M, N, Q		<b>RTA 2</b>											
 <p><b>MB Multi - Tilter</b> COM Yardage: 1.75 Freight Class: 125 Product Weight (lbs.): 61 Cubic Feet Per Carton: 9.25</p>	 <p><b>ADJUSTMENTS</b> (1) Tilt tension (2) Pneumatic seat height (3) Back angle (6) Back height* (7) Forward tilt lock (9) Chair tilt lock (5A) Center-tilt action</p>	1171-3	806	847	879	926	997	1021	1080	1194	1250	1355	1500	1679
			<b>OVERALL DIMENSIONS</b>			<b>SEAT DIMENSIONS</b>			<b>BACK DIMENSIONS</b>					
			<b>W</b>	<b>D</b>	<b>H</b>	<b>W</b>	<b>D</b>	<b>H</b>	<b>W</b>	<b>H</b>				
			26	23.5	42	21	18-20.5	16-20	20	23-28.25				
	Ergonomic Features: A, B, C, D, E, F, G, H, M, N, Q, S, U		<b>RTA 2</b>											
 <p><b>MB Operator</b> COM Yardage: 1.75 Freight Class: 150 Product Weight (lbs.): 54 Cubic Feet Per Carton: 9.25</p>	 <p><b>ADJUSTMENTS</b> (2) Pneumatic seat height (4) Seat/Back angle (6) Back Height Free floating seat and back</p>	1171-5	778	819	851	900	970	993	1052	1167	1222	1327	1472	1652
			<b>OVERALL DIMENSIONS</b>			<b>SEAT DIMENSIONS</b>			<b>BACK DIMENSIONS</b>					
			<b>W</b>	<b>D</b>	<b>H</b>	<b>W</b>	<b>D</b>	<b>H</b>	<b>W</b>	<b>H</b>				
			26	23.5	39	21	18	16.5-20.5	20	19-24.25				
	Ergonomic Features: C, D, F, G, H, M, N, Q, S, U		<b>RTA 2</b>											
 <p><b>MB Task</b> COM Yardage: 1.75 Freight Class: 150 Product Weight (lbs.): 49 Cubic Feet Per Carton: 9.25</p>	 <p><b>ADJUSTMENTS</b> (2) Pneumatic seat height (8) Seat depth</p>	1171-6	656	697	730	777	847	871	931	1046	1100	1206	1351	1529
			<b>OVERALL DIMENSIONS</b>			<b>SEAT DIMENSIONS</b>			<b>BACK DIMENSIONS</b>					
			<b>W</b>	<b>D</b>	<b>H</b>	<b>W</b>	<b>D</b>	<b>H</b>	<b>W</b>	<b>H</b>				
			26	23.5	38	21	17-18	16-21	20	19				
	Ergonomic Features: C, E, H, M, N, U, Q		<b>RTA 2</b>											
 <p><b>MB Weight Sensing Synchro - Tilter</b> COM Yardage: 1.75 Freight Class: 125 Product Weight (lbs.): 61 Cubic Feet Per Carton: 9.25</p>	 <p><b>ADJUSTMENTS</b> Weight sensing auto tension adjustment (2) Pneumatic seat height (8) Sliding seat depth (9) Multi position tilt lock</p>	1171-8	806	847	879	926	997	1021	1080	1194	1250	1355	1500	1679
			<b>OVERALL DIMENSIONS</b>			<b>SEAT DIMENSIONS</b>			<b>BACK DIMENSIONS</b>					
			<b>W</b>	<b>D</b>	<b>H</b>	<b>W</b>	<b>D</b>	<b>H</b>	<b>W</b>	<b>H</b>				
			26	23.5	41	21	18-20.5	16.25-20.25	20	20 - 25.2				
	Ergonomic Features: A, B, C, D, E, H, L, M, N, Q		<b>RTA 2</b>											

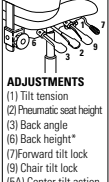
DESCRIPTION	FEATURES	MODEL#	STANDARD TEXTILE GRADES																								
			1	2	3	4	5	6	7	8	9	10	11	12													
 <p><b>MB Operator</b> Armless COM Yardage: 1.75 Freight Class: 150 Product Weight (lbs.): 49 Cubic Feet Per Carton: 9.25</p>	 <p><b>ADJUSTMENTS</b> (2) Pneumatic seat height (4) Seat/Back angle (6) Back Height Free floating seat and back.</p>	<p>Ergonomic Features: C, D, E, F, G, M, N, Q, S, U</p>	<table border="1"> <tr> <td><b>1172-5</b></td> <td>643</td> <td>683</td> <td>716</td> <td>764</td> <td>832</td> <td>855</td> <td>918</td> <td>1030</td> <td>1086</td> <td>1191</td> <td>1335</td> <td>1517</td> </tr> </table>												<b>1172-5</b>	643	683	716	764	832	855	918	1030	1086	1191	1335	1517
			<b>1172-5</b>	643	683	716	764	832	855	918	1030	1086	1191	1335	1517												
			<table border="1"> <thead> <tr> <th colspan="3">OVERALL DIMENSIONS</th> <th colspan="3">SEAT DIMENSIONS</th> <th colspan="2">BACK DIMENSIONS</th> </tr> <tr> <th>W</th> <th>D</th> <th>H</th> <th>W</th> <th>D</th> <th>H</th> <th>W</th> <th>H</th> </tr> </thead> <tbody> <tr> <td>21</td> <td>23.5</td> <td>39</td> <td>21</td> <td>18</td> <td>16.5-20.5</td> <td>20</td> <td>19-24.25</td> </tr> </tbody> </table>			OVERALL DIMENSIONS			SEAT DIMENSIONS			BACK DIMENSIONS		W	D	H	W	D	H	W	H	21	23.5	39	21	18	16.5-20.5
OVERALL DIMENSIONS			SEAT DIMENSIONS			BACK DIMENSIONS																					
W	D	H	W	D	H	W	H																				
21	23.5	39	21	18	16.5-20.5	20	19-24.25																				
<p>Ergonomic Features: C, E, H, M, N, U, Q</p>			<table border="1"> <tr> <td><b>1172-6</b></td> <td>521</td> <td>562</td> <td>594</td> <td>642</td> <td>710</td> <td>735</td> <td>796</td> <td>909</td> <td>964</td> <td>1070</td> <td>1214</td> <td>1394</td> </tr> </table>												<b>1172-6</b>	521	562	594	642	710	735	796	909	964	1070	1214	1394
<b>1172-6</b>	521	562	594	642	710	735	796	909	964	1070	1214	1394															
<table border="1"> <thead> <tr> <th colspan="3">OVERALL DIMENSIONS</th> <th colspan="3">SEAT DIMENSIONS</th> <th colspan="2">BACK DIMENSIONS</th> </tr> <tr> <th>W</th> <th>D</th> <th>H</th> <th>W</th> <th>D</th> <th>H</th> <th>W</th> <th>H</th> </tr> </thead> <tbody> <tr> <td>21</td> <td>23.5</td> <td>38</td> <td>21</td> <td>17-18</td> <td>16-21</td> <td>20</td> <td>19</td> </tr> </tbody> </table>			OVERALL DIMENSIONS			SEAT DIMENSIONS			BACK DIMENSIONS		W	D	H	W	D	H	W	H	21	23.5	38	21	17-18	16-21	20	19	<p>RTA 2</p> 
OVERALL DIMENSIONS			SEAT DIMENSIONS			BACK DIMENSIONS																					
W	D	H	W	D	H	W	H																				
21	23.5	38	21	17-18	16-21	20	19																				
 <p><b>Side Chair</b> COM Yardage: 1.75 Freight Class: 250 Product Weight (lbs.): 35 Cubic Feet Per Carton: 10</p>	 <p><b>ADJUSTMENTS</b> (2) Pneumatic seat height (8) Seat depth</p>	<p>Ergonomic Features: M, N</p>	<table border="1"> <tr> <td><b>1174</b></td> <td>465</td> <td>503</td> <td>538</td> <td>587</td> <td>654</td> <td>678</td> <td>739</td> <td>852</td> <td>906</td> <td>1013</td> <td>1157</td> <td>1337</td> </tr> </table>												<b>1174</b>	465	503	538	587	654	678	739	852	906	1013	1157	1337
			<b>1174</b>	465	503	538	587	654	678	739	852	906	1013	1157	1337												
			<table border="1"> <thead> <tr> <th colspan="3">OVERALL DIMENSIONS</th> <th colspan="3">SEAT DIMENSIONS</th> <th colspan="2">BACK DIMENSIONS</th> </tr> <tr> <th>W</th> <th>D</th> <th>H</th> <th>W</th> <th>D</th> <th>H</th> <th>W</th> <th>H</th> </tr> </thead> <tbody> <tr> <td>21</td> <td>24</td> <td>38</td> <td>21</td> <td>18</td> <td>18</td> <td>20</td> <td>20.5</td> </tr> </tbody> </table>			OVERALL DIMENSIONS			SEAT DIMENSIONS			BACK DIMENSIONS		W	D	H	W	D	H	W	H	21	24	38	21	18	18
OVERALL DIMENSIONS			SEAT DIMENSIONS			BACK DIMENSIONS																					
W	D	H	W	D	H	W	H																				
21	24	38	21	18	18	20	20.5																				
<p>Ergonomic Features: M, N</p>			<table border="1"> <tr> <td><b>1175</b></td> <td>622</td> <td>663</td> <td>695</td> <td>742</td> <td>811</td> <td>835</td> <td>897</td> <td>1011</td> <td>1064</td> <td>1171</td> <td>1315</td> <td>1495</td> </tr> </table>												<b>1175</b>	622	663	695	742	811	835	897	1011	1064	1171	1315	1495
<b>1175</b>	622	663	695	742	811	835	897	1011	1064	1171	1315	1495															
<table border="1"> <thead> <tr> <th colspan="3">OVERALL DIMENSIONS</th> <th colspan="3">SEAT DIMENSIONS</th> <th colspan="2">BACK DIMENSIONS</th> </tr> <tr> <th>W</th> <th>D</th> <th>H</th> <th>W</th> <th>D</th> <th>H</th> <th>W</th> <th>H</th> </tr> </thead> <tbody> <tr> <td>24.5</td> <td>24</td> <td>38</td> <td>21</td> <td>18</td> <td>18</td> <td>20</td> <td>20.5</td> </tr> </tbody> </table>			OVERALL DIMENSIONS			SEAT DIMENSIONS			BACK DIMENSIONS		W	D	H	W	D	H	W	H	24.5	24	38	21	18	18	20	20.5	<p>RTA 2</p> 
OVERALL DIMENSIONS			SEAT DIMENSIONS			BACK DIMENSIONS																					
W	D	H	W	D	H	W	H																				
24.5	24	38	21	18	18	20	20.5																				
 <p><b>Drafting Stool Operator</b> Armless COM Yardage: 1.75 Freight Class: 150 Product Weight (lbs.): 52 Cubic Feet Per Carton: 9.25</p>	 <p><b>ADJUSTMENTS</b> (2) Pneumatic seat height (4) Seat/Back angle (6) Back Height Free floating seat and back.</p>	<p>Ergonomic Features: C, D, F, G, H, M, N, S, U</p>	<table border="1"> <tr> <td><b>1177-5</b></td> <td>809</td> <td>849</td> <td>881</td> <td>929</td> <td>999</td> <td>1023</td> <td>1083</td> <td>1197</td> <td>1252</td> <td>1357</td> <td>1502</td> <td>1682</td> </tr> </table>												<b>1177-5</b>	809	849	881	929	999	1023	1083	1197	1252	1357	1502	1682
			<b>1177-5</b>	809	849	881	929	999	1023	1083	1197	1252	1357	1502	1682												
			<table border="1"> <thead> <tr> <th colspan="3">OVERALL DIMENSIONS</th> <th colspan="3">SEAT DIMENSIONS</th> <th colspan="2">BACK DIMENSIONS</th> </tr> <tr> <th>W</th> <th>D</th> <th>H</th> <th>W</th> <th>D</th> <th>H</th> <th>W</th> <th>H</th> </tr> </thead> <tbody> <tr> <td>21</td> <td>23.5</td> <td>48</td> <td>20</td> <td>18</td> <td>23.5-33.5</td> <td>20</td> <td>19-24.25</td> </tr> </tbody> </table>			OVERALL DIMENSIONS			SEAT DIMENSIONS			BACK DIMENSIONS		W	D	H	W	D	H	W	H	21	23.5	48	20	18	23.5-33.5
OVERALL DIMENSIONS			SEAT DIMENSIONS			BACK DIMENSIONS																					
W	D	H	W	D	H	W	H																				
21	23.5	48	20	18	23.5-33.5	20	19-24.25																				
<p>Ergonomic Features: C, D, F, G, H, M, N, S, U</p>			<table border="1"> <tr> <td><b>1177-5</b></td> <td>809</td> <td>849</td> <td>881</td> <td>929</td> <td>999</td> <td>1023</td> <td>1083</td> <td>1197</td> <td>1252</td> <td>1357</td> <td>1502</td> <td>1682</td> </tr> </table>												<b>1177-5</b>	809	849	881	929	999	1023	1083	1197	1252	1357	1502	1682
<b>1177-5</b>	809	849	881	929	999	1023	1083	1197	1252	1357	1502	1682															

DESCRIPTION	FEATURES	MODEL#	STANDARD TEXTILE GRADES													
			1	2	3	4	5	6	7	8	9	10	11	12		
 <p><b>Drafting Stool Operator w/Arm</b> COM Yardage: 1.75 Freight Class: 125 Product Weight (lbs.): 57 Cubic Feet Per Carton: 9.25</p>	 <p><b>ADJUSTMENTS</b> (2) Pneumatic seat height (4) Seat/Back angle (6) Back Height Free floating seat and back.</p>	<p>Ergonomic Features: C, D, F, G, H, M, N, S, U</p>	1178-5	944	982	1017	1064	1133	1157	1217	1331	1386	1492	1636	1816	
			<b>OVERALL DIMENSIONS</b>			<b>SEAT DIMENSIONS</b>			<b>BACK DIMENSIONS</b>							
			<b>W</b>	<b>D</b>	<b>H</b>	<b>W</b>	<b>D</b>	<b>H</b>	<b>W</b>	<b>H</b>						
			26	23.5	48	21	18	23.5-33.5	20	19-24.25						
			<b>RTA 2</b>													
 <p><b>HB Synchro Knee - Tilter w/ Schukra Lumbar</b> COM Yardage: 2 Freight Class: 125 Product Weight (lbs.): 63 Cubic Feet Per Carton: 9.25</p>	 <p><b>ADJUSTMENTS</b> (1) Tilt tension (2) Pneumatic seat height (8) Seat depth (9) Chair tilt lock (5B) Knee-tilt action (5C) Synchro action Free Float seat</p>	<p>Ergonomic Features: A, B, C, D, E, G, H, J, M, N, Q, R, V</p>	1190-2	1227	1281	1324	1388	1480	1510	1592	1743	1816	1959	2150	2390	
			<b>OVERALL DIMENSIONS</b>			<b>SEAT DIMENSIONS</b>			<b>BACK DIMENSIONS</b>							
			<b>W</b>	<b>D</b>	<b>H</b>	<b>W</b>	<b>D</b>	<b>H</b>	<b>W</b>	<b>H</b>						
			26	23.5	45.5	21	18-20.5	16.5-20.5	20	23-28.25						
			<b>RTA 2</b>													
 <p><b>HB Multi - Tilter</b> COM Yardage: 2 Freight Class: 125 Product Weight (lbs.): 65 Cubic Feet Per Carton: 9.25</p>	 <p><b>ADJUSTMENTS</b> (1) Tilt tension (2) Pneumatic seat height (3) Back angle (6) Back height* (7) Forward tilt lock (9) Chair tilt lock (5A) Center-tilt action</p>	<p>Ergonomic Features: A, B, C, D, E, F, G, H, M, N, Q, S, U</p>	1190-3	1109	1163	1207	1270	1362	1395	1474	1627	1699	1842	2033	2273	
			<b>OVERALL DIMENSIONS</b>			<b>SEAT DIMENSIONS</b>			<b>BACK DIMENSIONS</b>							
			<b>W</b>	<b>D</b>	<b>H</b>	<b>W</b>	<b>D</b>	<b>H</b>	<b>W</b>	<b>H</b>						
			26	23.5	45	21	18-20.5	16-20	20	23-28.25						
			<b>RTA 2</b>													
 <p><b>MB Synchro Knee - Tilter w/ Schukra Lumbar</b> COM Yardage: 1.75 Freight Class: 125 Product Weight (lbs.): 61 Cubic Feet Per Carton: 9.25</p>	 <p><b>ADJUSTMENTS</b> (1) Tilt tension (2) Pneumatic seat height (8) Seat depth (9) Chair tilt lock (5B) Knee-tilt action (5C) Synchro action Free Float seat</p>	<p>Ergonomic Features: A, B, C, D, E, G, H, J, M, N, Q, R, V</p>	1191-2	1127	1176	1214	1268	1351	1379	1449	1581	1645	1769	1937	2146	
			<b>OVERALL DIMENSIONS</b>			<b>SEAT DIMENSIONS</b>			<b>BACK DIMENSIONS</b>							
			<b>W</b>	<b>D</b>	<b>H</b>	<b>W</b>	<b>D</b>	<b>H</b>	<b>W</b>	<b>H</b>						
			26	23.5	42.5	21	18-20.5	16-20	20	23-28.51						
			<b>RTA 2</b>													
 <p><b>MB Multi - Tilter</b> COM Yardage: 1.75 Freight Class: 125 Product Weight (lbs.): 61 Cubic Feet Per Carton: 9.25</p>	 <p><b>ADJUSTMENTS</b> (1) Tilt tension (2) Pneumatic seat height (3) Back angle (6) Back height* (7) Forward tilt lock (9) Chair tilt lock (5A) Center-tilt action</p>	<p>Ergonomic Features: A, B, C, D, E, F, G, H, M, N, Q, S, U</p>	1191-3	1007	1054	1094	1149	1229	1258	1327	1460	1525	1647	1816	2025	
			<b>OVERALL DIMENSIONS</b>			<b>SEAT DIMENSIONS</b>			<b>BACK DIMENSIONS</b>							
			<b>W</b>	<b>D</b>	<b>H</b>	<b>W</b>	<b>D</b>	<b>H</b>	<b>W</b>	<b>H</b>						
			26	23.5	42	21	18-20.5	16-20	20	23-28.25						
			<b>RTA 2</b>													

GRAPHIC™



model 2739



model 2738MB



**Optional Base**  
An optional five-legged, arched steel base in Tungsten finish is available. Specify (TUN). Add \$65.









STANDARD FEATURES

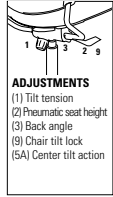

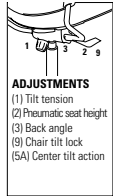

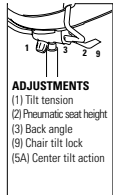

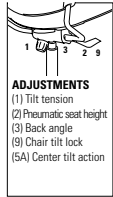



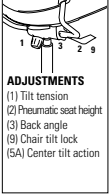

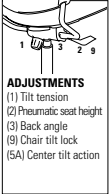
- European detailing and a clean slim profile.
- Features a generous compound curved back and seat.
- Three distinctive back styles: upholstered back, perforated black nylon back and a breathable black mesh back.
- Posture back chairs with arms are standard with adjustable height, forward swept arms and "sliding armcaps" (G4).
- (WA) Arm width is standard, providing 2 inches of arm width spacing adjustment on each side of the seat.
- Available in all standard GLOBAL carded fabrics
- Posture mechanism offers exceptional back support, two position tilt lock adjustment and tilt tension control.

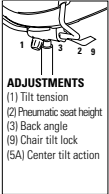
- Standard with a five-legged, injection molded, fiberglass reinforced nylon arched base with C1 casters in Black.

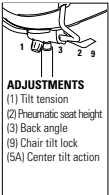
OPTIONAL FEATURES

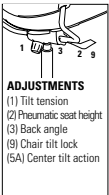
- For hard surface flooring please specify C9R. Add \$51.
- A steel base with Tungsten finish is available at an upcharge. Please specify TUN. Add \$65.
- Please refer to "Arms and Casters" section of the price book for arm and caster options.
- For fully assembled in box, please specify SU. Add \$55.

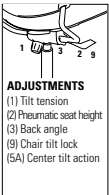
DESCRIPTION	FEATURES	MODEL#	STANDARD TEXTILE GRADES											
			1	2	3	4	5	6	7	8	9	10	11	12
 <p><b>Medium Posture Nylon Back</b> Armless COM Yardage: 1 Freight Class: 250 Product Weight (lbs.): 34 Cubic Feet Per Carton: 9.75</p>	 <p><b>ADJUSTMENTS</b> (1) Tilt tension (2) Pneumatic seat height (3) Back angle (9) Chair tilt lock (5A) Center tilt action</p>	<b>2736</b>	540	568	589	617	663	678	715	788	823	890	980	1096
		<b>OVERALL DIMENSIONS</b>			<b>SEAT DIMENSIONS</b>			<b>BACK DIMENSIONS</b>						
		<b>W</b>	<b>D</b>	<b>H</b>	<b>W</b>	<b>D</b>	<b>H</b>	<b>W</b>		<b>H</b>				
		20	24	36	20	19	16.5-20.5	19		19				
			<b>RTA 1</b>											
 <p><b>Medium Posture Mesh Back</b> Armless COM Yardage: 1 Freight Class: 250 Product Weight (lbs.): 34 Cubic Feet Per Carton: 9.75</p>	 <p><b>ADJUSTMENTS</b> (1) Tilt tension (2) Pneumatic seat height (3) Back angle (9) Chair tilt lock (5A) Center tilt action</p>	<b>2736MB</b>	599	628	647	678	723	738	775	848	882	950	1041	1156
		<b>OVERALL DIMENSIONS</b>			<b>SEAT DIMENSIONS</b>			<b>BACK DIMENSIONS</b>						
		<b>W</b>	<b>D</b>	<b>H</b>	<b>W</b>	<b>D</b>	<b>H</b>	<b>W</b>		<b>H</b>				
		20	24	36	20	19	16.5-20.5	19		19				
			<b>RTA 1</b>											
 <p><b>Medium Posture Back - Fully Upholstered</b> Armless COM Yardage: 1.25 Freight Class: 250 Product Weight (lbs.): 34 Cubic Feet Per Carton: 9.75</p>	 <p><b>ADJUSTMENTS</b> (1) Tilt tension (2) Pneumatic seat height (3) Back angle (9) Chair tilt lock (5A) Center tilt action</p>	<b>2737</b>	599	632	658	696	750	770	816	907	951	1035	1150	1291
		<b>OVERALL DIMENSIONS</b>			<b>SEAT DIMENSIONS</b>			<b>BACK DIMENSIONS</b>						
		<b>W</b>	<b>D</b>	<b>H</b>	<b>W</b>	<b>D</b>	<b>H</b>	<b>W</b>		<b>H</b>				
		20	24	36	20	19	16.5-20.5	19		19				
			<b>RTA 1</b>											
 <p><b>Medium Posture Nylon Back</b> w/Arms COM Yardage: 1 Freight Class: 150 Product Weight (lbs.): 45 Cubic Feet Per Carton: 9.75</p>	 <p><b>ADJUSTMENTS</b> (1) Tilt tension (2) Pneumatic seat height (3) Back angle (9) Chair tilt lock (5A) Center tilt action</p>	<b>2738</b>	599	627	646	677	720	736	774	847	881	949	1040	1155
		<b>OVERALL DIMENSIONS</b>			<b>SEAT DIMENSIONS</b>			<b>BACK DIMENSIONS</b>						
		<b>W</b>	<b>D</b>	<b>H</b>	<b>W</b>	<b>D</b>	<b>H</b>	<b>W</b>		<b>H</b>				
		25	24	36	20	19	16.5-20.5	19		19				
			<b>RTA 1</b>											

DESCRIPTION	FEATURES	MODEL#	STANDARD TEXTILE GRADES													
			1	2	3	4	5	6	7	8	9	10	11	12		
 <p><b>Medium Posture Mesh Back w/Arms</b> COM Yardage: 1 Freight Class: 150 Product Weight (lbs.):45 Cubic Feet Per Carton: 9.75</p>	 <p><b>ADJUSTMENTS</b> (1) Tilt tension (2) Pneumatic seat height (3) Back angle (9) Chair tilt lock (5A) Center tilt action</p>	<b>2738MB</b>	660	688	707	738	781	798	834	907	943	1010	1101	1215		
			<b>OVERALL DIMENSIONS</b>			<b>SEAT DIMENSIONS</b>			<b>BACK DIMENSIONS</b>							
			<b>W</b>	<b>D</b>	<b>H</b>	<b>W</b>	<b>D</b>	<b>H</b>	<b>W</b>	<b>H</b>						
			25	24	36	20	19	16.5-20.5	19	19						
			<b>RTA 1</b>													
 <p><b>Medium Posture Back - Fully Upholstered w/Arms</b> COM Yardage: 1.25 Freight Class: 150 Product Weight (lbs.):45 Cubic Feet Per Carton: 9.75</p>	 <p><b>ADJUSTMENTS</b> (1) Tilt tension (2) Pneumatic seat height (3) Back angle (9) Chair tilt lock (5A) Center tilt action</p>	<b>2739</b>	660	692	717	755	810	830	877	968	1011	1095	1210	1352		
			<b>OVERALL DIMENSIONS</b>			<b>SEAT DIMENSIONS</b>			<b>BACK DIMENSIONS</b>							
			<b>W</b>	<b>D</b>	<b>H</b>	<b>W</b>	<b>D</b>	<b>H</b>	<b>W</b>	<b>H</b>						
			25	24	36	20	19	16.5-20.5	19	19						
			<b>RTA 1</b>													
 <p><b>Medium Posture Stool Nylon Back w/Arms</b> COM Yardage: 1 Freight Class: 150 Product Weight (lbs.): 50 Cubic Feet Per Carton: 9.75</p>	 <p><b>ADJUSTMENTS</b> (1) Tilt tension (2) Pneumatic seat height (3) Back angle (9) Chair tilt lock (5A) Center tilt action</p>	<b>2748</b>	755	782	805	836	882	899	939	1014	1051	1122	1217	1337		
			<b>OVERALL DIMENSIONS</b>			<b>SEAT DIMENSIONS</b>			<b>BACK DIMENSIONS</b>							
			<b>W</b>	<b>D</b>	<b>H</b>	<b>W</b>	<b>D</b>	<b>H</b>	<b>W</b>	<b>H</b>						
			25	24	46	20	19	23-33	19	19						
			<b>RTA 1</b>													
 <p><b>Medium Posture Stool Mesh Back w/Arms</b> COM Yardage: 1 Freight Class: 150 Product Weight (lbs.): 51 Cubic Feet Per Carton: 9.75</p>	 <p><b>ADJUSTMENTS</b> (1) Tilt tension (2) Pneumatic seat height (3) Back angle (9) Chair tilt lock (5A) Center tilt action</p>	<b>2748MB</b>	819	847	869	901	946	961	1003	1078	1115	1186	1282	1401		
			<b>OVERALL DIMENSIONS</b>			<b>SEAT DIMENSIONS</b>			<b>BACK DIMENSIONS</b>							
			<b>W</b>	<b>D</b>	<b>H</b>	<b>W</b>	<b>D</b>	<b>H</b>	<b>W</b>	<b>H</b>						
			25	24	46	20	19	23-33	19	19						
			<b>RTA 1</b>													
 <p><b>Medium Posture Stool Back - Fully Upholstered w/Arms</b> COM Yardage: 1.25 Freight Class: 150 Product Weight (lbs.): 52 Cubic Feet Per Carton: 9.75</p>	 <p><b>ADJUSTMENTS</b> (1) Tilt tension (2) Pneumatic seat height (3) Back angle (9) Chair tilt lock (5A) Center tilt action</p>	<b>2749</b>	815	849	877	917	974	994	1045	1139	1185	1274	1393	1542		
			<b>OVERALL DIMENSIONS</b>			<b>SEAT DIMENSIONS</b>			<b>BACK DIMENSIONS</b>							
			<b>W</b>	<b>D</b>	<b>H</b>	<b>W</b>	<b>D</b>	<b>H</b>	<b>W</b>	<b>H</b>						
			25	24	46	20	19	23-33	19	19						
			<b>RTA 1</b>													
 <p><b>2749L</b></p>	 <p><b>ADJUSTMENTS</b> (1) Tilt tension (2) Pneumatic seat height (3) Back angle (9) Chair tilt lock (5A) Center tilt action</p>	<b>2749L</b>	815	849	877	917	974	994	1045	1139	1185	1274	1393	1542		
			<b>OVERALL DIMENSIONS</b>			<b>SEAT DIMENSIONS</b>			<b>BACK DIMENSIONS</b>							
			<b>W</b>	<b>D</b>	<b>H</b>	<b>W</b>	<b>D</b>	<b>H</b>	<b>W</b>	<b>H</b>						
			25	24	46	20	19	23-33	19	19						
			<b>RTA 1</b>													





LOOVER



model 2660-8



model 2660-3



**Memory Foam**  
Available, use code "MF"  
and Add \$81.00.



model 2661-8



model 2662-3

STANDARD FEATURES

- Global's first chair to feature a Weight Sensing Synchro-Tilter mechanism that requires no tilt tension adjustment.
- A live lumbar support is incorporated into the back design which is height adjustable via a concealed ratchet system, offering a 2.25" height adjustment.
- Standard with Global's high quality Soft Descent™ Pneumatic lift which slowly and gently lowers the seat height of the chair making it easy to obtain exactly the right seat height you desire.
- Side activated sliding seat depth adjustment, (MD) is standard on for Mutil-Tilters, Synchro-Tilters, and Weight Sensing Synchro-Tilter. Provides 2"-3" of seat depth adjustment.
- Height and width (WA) adjustable G5 lockable arms. Armcaps are soft to the touch Self Skinned Urethane, depth adjustable (slide forward and backward) movements can be locked to avoid unintentional movement). Armcaps also articulate inwards and outwards 30° to aim toward the keyboard or mouse arena.
- Vari-Width (WA) Width Adjustable Arm Extensions are standard, allowing the arms to move away from the seat by 2" on each side to allow space if desired for broader hip widths.

- Five legged, injection molded, fiberglass reinforced, Nylon medium rise base **B7B** with **C1** dual wheel casters.

OPTIONAL FEATURES

- There are 24 "Vue" mesh colors to choose from for the back of the chair.
- Petite models are available at no upcharge. Please specify P. Seat is overall 1 inch smaller in depth and 1.5 inch smaller in width. Model numbers are listed below.
- Available with Memory Foam (MF). Add \$84.
- Optional polished Aluminum base (B7A) Please specify **ALU** base. Add \$121.
- For hard surface flooring casters, please specify **C9R**. Add \$51.
- Upholstery is available in Fabric, Vinyl or Leather.
- Please refer to "Arms Selection" section of the price book for arm options. Please refer to "Cylinder Selection" section of the price book for additional cylinder options.
- For fully assembled in box, please specify **SU**. Add \$55.

DESCRIPTION FEATURES MODEL# STANDARD TEXTILE GRADES



**Extended HB Synchro - Tilter w/Back Angle Adjustment**  
COM Yardage: 1  
Freight Class: 125  
Product Weight (lbs.): 66  
Cubic Feet Per Carton: 11

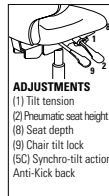

**ADJUSTMENTS**  
(1) Tilt tension  
(2) Pneumatic seat height  
(8) Seat depth  
(9) Chair tilt lock  
(SC) Synchro-tilt action  
Anti-Kick back

Ergonomic Features:  
A, B, C, D, E, G, H, L, M, N, Q, R, U

	1	2	3	4	5	6	7	8	9	10	11	12
<b>2660-0</b>	851	879	900	931	974	988	1027	1100	1135	1201	1292	1407
2660P-0 Small Seat												

OVERALL DIMENSIONS			SEAT DIMENSIONS			BACK DIMENSIONS	
W	D	H	W	D	H	W	H
25.5	25	45	20	19-21.5	16.25-20.25	19.5	26.5-29

RTA 2



**Extended HB Multi Tilter**  
COM Yardage: 1  
Freight Class: 125  
Product Weight (lbs.): 68  
Cubic Feet Per Carton: 11

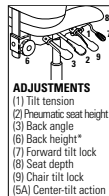

**ADJUSTMENTS**  
(1) Tilt tension  
(2) Pneumatic seat height  
(3) Back angle  
(6) Back height\*  
(7) Forward tilt lock  
(8) Seat depth  
(9) Chair tilt lock  
(SA) Center-tilt action

Ergonomic Features:  
A, B, C, D, E, F, G, H, M, N, Q, R, S, U

	1	2	3	4	5	6	7	8	9	10	11	12
<b>2660-3</b>	851	879	900	931	974	988	1027	1100	1135	1201	1292	1407
2660P-3 Small Seat												

OVERALL DIMENSIONS			SEAT DIMENSIONS			BACK DIMENSIONS	
W	D	H	W	D	H	W	H
25.5	25	45.5	20	19-21.5	16-20	19.5	26.5-29

RTA 2



**Extended HB Tilter**  
COM Yardage: 1  
Freight Class: 150  
Product Weight (lbs.): 62  
Cubic Feet Per Carton: 11

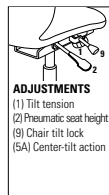











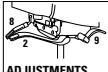



**ADJUSTMENTS**  
(1) Tilt tension  
(2) Pneumatic seat height  
(9) Chair tilt lock  
(SA) Center-tilt action

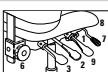

Ergonomic Features:  
A, B, C, D, H, M, N, Q, R, S, U

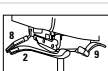

	1	2	3	4	5	6	7	8	9	10	11	12
<b>2660-4</b>	743	770	791	821	865	879	918	989	1025	1092	1183	1298
2660P-4 Small Seat												

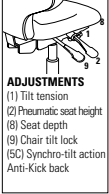

OVERALL DIMENSIONS			SEAT DIMENSIONS			BACK DIMENSIONS	
W	D	H	W	D	H	W	H
25.5	25	45.5	20	19-20	16-20	19.5	26.5-29

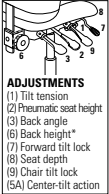

RTA 2

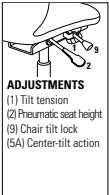

DESCRIPTION	FEATURES	MODEL#	STANDARD TEXTILE GRADES																																					
			1	2	3	4	5	6	7	8	9	10	11	12																										
 <p><b>Extended HB Weight Sensing Synchro - Tilter</b> COM Yardage: 1 Freight Class: 125 Product Weight (lbs.): 66 Cubic Feet Per Carton: 11</p>	 <p><b>ADJUSTMENTS</b> Weight sensing auto tension adjustment (2) Pneumatic seat height (8) Sliding seat depth (9) Multi position tilt lock</p>	<p>Ergonomic Features: A, B, C, D, E, H, L, M, N, Q, R, U</p>	<table border="1"> <tr> <td>2660-8</td> <td>851</td> <td>879</td> <td>900</td> <td>931</td> <td>974</td> <td>988</td> <td>1027</td> <td>1100</td> <td>1135</td> <td>1201</td> <td>1292</td> <td>1407</td> </tr> <tr> <td colspan="13">2660P-8 Small Seat</td> </tr> </table>												2660-8	851	879	900	931	974	988	1027	1100	1135	1201	1292	1407	2660P-8 Small Seat												
			2660-8	851	879	900	931	974	988	1027	1100	1135	1201	1292	1407																									
			2660P-8 Small Seat																																					
<table border="1"> <thead> <tr> <th colspan="3">OVERALL DIMENSIONS</th> <th colspan="3">SEAT DIMENSIONS</th> <th colspan="3">BACK DIMENSIONS</th> </tr> <tr> <th>W</th> <th>D</th> <th>H</th> <th>W</th> <th>D</th> <th>H</th> <th>W</th> <th>H</th> </tr> </thead> <tbody> <tr> <td>25.5</td> <td>25</td> <td>45.5</td> <td>20</td> <td>19-21.5</td> <td>16-20</td> <td>19.5</td> <td>25-27.5</td> </tr> </tbody> </table>			OVERALL DIMENSIONS			SEAT DIMENSIONS			BACK DIMENSIONS			W	D	H	W	D	H	W	H	25.5	25	45.5	20	19-21.5	16-20	19.5	25-27.5													
OVERALL DIMENSIONS			SEAT DIMENSIONS			BACK DIMENSIONS																																		
W	D	H	W	D	H	W	H																																	
25.5	25	45.5	20	19-21.5	16-20	19.5	25-27.5																																	
<p>RTA 2 </p>																																								
 <p><b>HB Synchro - Tilter w/Back Angle Adjustment</b> COM Yardage: 1 Freight Class: 125 Product Weight (lbs.): 66 Cubic Feet Per Carton: 10.50</p>	 <p><b>ADJUSTMENTS</b> (1) Tilt tension (2) Pneumatic seat height (8) Seat depth (9) Chair tilt lock (5C) Synchro-tilt action Anti-Kick back</p>	<p>Ergonomic Features: A, B, C, D, E, G, H, L, M, N, Q, R, U</p>	<table border="1"> <tr> <td>2661-0</td> <td>795</td> <td>821</td> <td>842</td> <td>872</td> <td>916</td> <td>931</td> <td>970</td> <td>1041</td> <td>1077</td> <td>1144</td> <td>1234</td> <td>1350</td> </tr> <tr> <td colspan="13">2661P-0 Small Seat</td> </tr> </table>												2661-0	795	821	842	872	916	931	970	1041	1077	1144	1234	1350	2661P-0 Small Seat												
			2661-0	795	821	842	872	916	931	970	1041	1077	1144	1234	1350																									
			2661P-0 Small Seat																																					
<table border="1"> <thead> <tr> <th colspan="3">OVERALL DIMENSIONS</th> <th colspan="3">SEAT DIMENSIONS</th> <th colspan="3">BACK DIMENSIONS</th> </tr> <tr> <th>W</th> <th>D</th> <th>H</th> <th>W</th> <th>D</th> <th>H</th> <th>W</th> <th>H</th> </tr> </thead> <tbody> <tr> <td>25.5</td> <td>25</td> <td>42</td> <td>20</td> <td>19-21.5</td> <td>16-20</td> <td>19.5</td> <td>25-27.5</td> </tr> </tbody> </table>			OVERALL DIMENSIONS			SEAT DIMENSIONS			BACK DIMENSIONS			W	D	H	W	D	H	W	H	25.5	25	42	20	19-21.5	16-20	19.5	25-27.5													
OVERALL DIMENSIONS			SEAT DIMENSIONS			BACK DIMENSIONS																																		
W	D	H	W	D	H	W	H																																	
25.5	25	42	20	19-21.5	16-20	19.5	25-27.5																																	
<p>RTA 2 </p>																																								
 <p><b>HB Multi - Tilter</b> COM Yardage: 1 Freight Class: 125 Product Weight (lbs.): 68 Cubic Feet Per Carton: 10.50</p>	 <p><b>ADJUSTMENTS</b> (1) Tilt tension (2) Pneumatic seat height (3) Back angle (8) Back height* (7) Forward tilt lock (8) Seat depth (9) Chair tilt lock (5A) Center-tilt action</p>	<p>Ergonomic Features: A, B, C, D, E, F, G, H, M, N, Q, R, S, U</p>	<table border="1"> <tr> <td>2661-3</td> <td>795</td> <td>821</td> <td>842</td> <td>872</td> <td>916</td> <td>931</td> <td>970</td> <td>1041</td> <td>1077</td> <td>1144</td> <td>1234</td> <td>1350</td> </tr> <tr> <td colspan="13">2661P-3 Small Seat</td> </tr> </table>												2661-3	795	821	842	872	916	931	970	1041	1077	1144	1234	1350	2661P-3 Small Seat												
			2661-3	795	821	842	872	916	931	970	1041	1077	1144	1234	1350																									
			2661P-3 Small Seat																																					
<table border="1"> <thead> <tr> <th colspan="3">OVERALL DIMENSIONS</th> <th colspan="3">SEAT DIMENSIONS</th> <th colspan="3">BACK DIMENSIONS</th> </tr> <tr> <th>W</th> <th>D</th> <th>H</th> <th>W</th> <th>D</th> <th>H</th> <th>W</th> <th>H</th> </tr> </thead> <tbody> <tr> <td>25.5</td> <td>25</td> <td>42.5</td> <td>20</td> <td>19-21.5</td> <td>16-20</td> <td>19.5</td> <td>25-27.5</td> </tr> </tbody> </table>			OVERALL DIMENSIONS			SEAT DIMENSIONS			BACK DIMENSIONS			W	D	H	W	D	H	W	H	25.5	25	42.5	20	19-21.5	16-20	19.5	25-27.5													
OVERALL DIMENSIONS			SEAT DIMENSIONS			BACK DIMENSIONS																																		
W	D	H	W	D	H	W	H																																	
25.5	25	42.5	20	19-21.5	16-20	19.5	25-27.5																																	
<p>RTA 2 </p>																																								
 <p><b>HB Tilter</b> COM Yardage: 1 Freight Class: 150 Product Weight (lbs.): 62 Cubic Feet Per Carton: 10.50</p>	 <p><b>ADJUSTMENTS</b> (1) Tilt tension (2) Pneumatic seat height (9) Chair tilt lock (5A) Center-tilt action</p>	<p>Ergonomic Features: A, B, C, D, H, M, N, Q, R, S, U</p>	<table border="1"> <tr> <td>2661-4</td> <td>698</td> <td>724</td> <td>744</td> <td>775</td> <td>818</td> <td>833</td> <td>872</td> <td>944</td> <td>979</td> <td>1047</td> <td>1138</td> <td>1252</td> </tr> <tr> <td colspan="13">2661P-4 Small Seat</td> </tr> </table>												2661-4	698	724	744	775	818	833	872	944	979	1047	1138	1252	2661P-4 Small Seat												
			2661-4	698	724	744	775	818	833	872	944	979	1047	1138	1252																									
			2661P-4 Small Seat																																					
<table border="1"> <thead> <tr> <th colspan="3">OVERALL DIMENSIONS</th> <th colspan="3">SEAT DIMENSIONS</th> <th colspan="3">BACK DIMENSIONS</th> </tr> <tr> <th>W</th> <th>D</th> <th>H</th> <th>W</th> <th>D</th> <th>H</th> <th>W</th> <th>H</th> </tr> </thead> <tbody> <tr> <td>25.5</td> <td>25</td> <td>42.5</td> <td>20</td> <td>19-20</td> <td>16-20</td> <td>19.5</td> <td>25-27.5</td> </tr> </tbody> </table>			OVERALL DIMENSIONS			SEAT DIMENSIONS			BACK DIMENSIONS			W	D	H	W	D	H	W	H	25.5	25	42.5	20	19-20	16-20	19.5	25-27.5													
OVERALL DIMENSIONS			SEAT DIMENSIONS			BACK DIMENSIONS																																		
W	D	H	W	D	H	W	H																																	
25.5	25	42.5	20	19-20	16-20	19.5	25-27.5																																	
<p>RTA 2 </p>																																								
 <p><b>HB Weight Sensing Synchro - Tilter</b> COM Yardage: 1 Freight Class: 125 Product Weight (lbs.): 66 Cubic Feet Per Carton: 10.50</p>	 <p><b>ADJUSTMENTS</b> Weight sensing auto tension adjustment (2) Pneumatic seat height (8) Sliding seat depth (9) Multi position tilt lock</p>	<p>Ergonomic Features: A, B, C, D, E, H, L, M, N, Q, R, U</p>	<table border="1"> <tr> <td>2661-8</td> <td>795</td> <td>821</td> <td>842</td> <td>872</td> <td>916</td> <td>931</td> <td>970</td> <td>1041</td> <td>1077</td> <td>1144</td> <td>1234</td> <td>1350</td> </tr> <tr> <td colspan="13">2661P-8 Small Seat</td> </tr> </table>												2661-8	795	821	842	872	916	931	970	1041	1077	1144	1234	1350	2661P-8 Small Seat												
			2661-8	795	821	842	872	916	931	970	1041	1077	1144	1234	1350																									
			2661P-8 Small Seat																																					
<table border="1"> <thead> <tr> <th colspan="3">OVERALL DIMENSIONS</th> <th colspan="3">SEAT DIMENSIONS</th> <th colspan="3">BACK DIMENSIONS</th> </tr> <tr> <th>W</th> <th>D</th> <th>H</th> <th>W</th> <th>D</th> <th>H</th> <th>W</th> <th>H</th> </tr> </thead> <tbody> <tr> <td>25.5</td> <td>24</td> <td>42.5</td> <td>20</td> <td>17.5-19.5</td> <td>16-20</td> <td>19.5</td> <td>25-27.5</td> </tr> </tbody> </table>			OVERALL DIMENSIONS			SEAT DIMENSIONS			BACK DIMENSIONS			W	D	H	W	D	H	W	H	25.5	24	42.5	20	17.5-19.5	16-20	19.5	25-27.5													
OVERALL DIMENSIONS			SEAT DIMENSIONS			BACK DIMENSIONS																																		
W	D	H	W	D	H	W	H																																	
25.5	24	42.5	20	17.5-19.5	16-20	19.5	25-27.5																																	
<p>RTA 2 </p>																																								



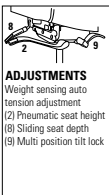

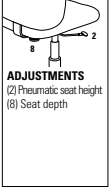

DESCRIPTION	FEATURES	MODEL#	STANDARD TEXTILE GRADES													
			1	2	3	4	5	6	7	8	9	10	11	12		
 <p><b>MB Synchro - Tilter w/Back Angle Adjustment</b> COM Yardage: 1 Freight Class: 125 Product Weight (lbs.): 64 Cubic Feet Per Carton: 10.50</p>	 <p><b>ADJUSTMENTS</b> (1) Tilt tension (2) Pneumatic seat height (6) Seat depth (9) Chair tilt lock (5C) Synchro-tilt action Anti-Kick back</p>	2662-0	760	786	807	837	881	897	935	1007	1043	1109	1200	1315		
		2662P-0 Small Seat		<b>OVERALL DIMENSIONS</b>			<b>SEAT DIMENSIONS</b>			<b>BACK DIMENSIONS</b>						
		<b>W</b>	<b>D</b>	<b>H</b>	<b>W</b>	<b>D</b>	<b>H</b>	<b>W</b>	<b>H</b>							
			25.5	25	39	20	17.5-19.5	16.25-20.25	19.5	22-24.5						
Ergonomic Features: A, B, C, D, E, G, H, L, M, N, Q, R, U		RTA 2														

DESCRIPTION	FEATURES	MODEL#	STANDARD TEXTILE GRADES													
			1	2	3	4	5	6	7	8	9	10	11	12		
 <p><b>MB Multi Tilter</b> COM Yardage: 1 Freight Class: 125 Product Weight (lbs.): 66 Cubic Feet Per Carton: 10.50</p>	 <p><b>ADJUSTMENTS</b> (1) Tilt tension (2) Pneumatic seat height (3) Back angle (6) Back height* (7) Forward tilt lock (8) Seat depth (9) Chair tilt lock (5A) Center-tilt action</p>	2662-3	760	786	807	837	881	897	935	1007	1043	1109	1200	1315		
		2662P-3 Small Seat		<b>OVERALL DIMENSIONS</b>			<b>SEAT DIMENSIONS</b>			<b>BACK DIMENSIONS</b>						
		<b>W</b>	<b>D</b>	<b>H</b>	<b>W</b>	<b>D</b>	<b>H</b>	<b>W</b>	<b>H</b>							
			25.5	25	39.5	20	19-21.5	16-20	19.5	22-24.5						
Ergonomic Features: A, B, C, D, E, F, G, H, M, N, Q, R, S, U		RTA 2														

DESCRIPTION	FEATURES	MODEL#	STANDARD TEXTILE GRADES													
			1	2	3	4	5	6	7	8	9	10	11	12		
 <p><b>MB Tilter</b> COM Yardage: 1 Freight Class: 150 Product Weight (lbs.): 60 Cubic Feet Per Carton: 10.50</p>	 <p><b>ADJUSTMENTS</b> (1) Tilt tension (2) Pneumatic seat height (9) Chair tilt lock (5A) Center-tilt action</p>	2662-4	675	702	723	753	797	811	850	922	957	1025	1116	1230		
		2662P-4 Small Seat		<b>OVERALL DIMENSIONS</b>			<b>SEAT DIMENSIONS</b>			<b>BACK DIMENSIONS</b>						
		<b>W</b>	<b>D</b>	<b>H</b>	<b>W</b>	<b>D</b>	<b>H</b>	<b>W</b>	<b>H</b>							
			25.5	25	39.5	20	19-20	16-20	19.5	22-24.5						
Ergonomic Features: A, B, C, D, H, M, N, Q, R, S, U		RTA 2														

DESCRIPTION	FEATURES	MODEL#	STANDARD TEXTILE GRADES													
			1	2	3	4	5	6	7	8	9	10	11	12		
 <p><b>MB Weight Sensing Synchro - Tilter</b> COM Yardage: 1 Freight Class: 125 Product Weight (lbs.): 64 Cubic Feet Per Carton: 10.50</p>	 <p><b>ADJUSTMENTS</b> Weight sensing auto tension adjustment (2) Pneumatic seat height (8) Sliding seat depth (9) Multi position tilt lock</p>	2662-8	760	786	807	837	881	897	935	1007	1043	1109	1200	1315		
		2662P-8 Small Seat		<b>OVERALL DIMENSIONS</b>			<b>SEAT DIMENSIONS</b>			<b>BACK DIMENSIONS</b>						
		<b>W</b>	<b>D</b>	<b>H</b>	<b>W</b>	<b>D</b>	<b>H</b>	<b>W</b>	<b>H</b>							
			25.5	24	39.5	20	17.5-19.5	16-20	19.5	22-24.5						
Ergonomic Features: A, B, C, D, E, H, L, M, N, Q, R, U		RTA 2														

DESCRIPTION	FEATURES	MODEL#	STANDARD TEXTILE GRADES													
			1	2	3	4	5	6	7	8	9	10	11	12		
 <p><b>MB Task</b> COM Yardage: 1 Freight Class: 150 Product Weight (lbs.): 45 Cubic Feet Per Carton: 10.50</p>	 <p><b>ADJUSTMENTS</b> (2) Pneumatic seat height (8) Seat depth</p>	2662-6	718	744	765	796	840	853	894	964	1000	1068	1158	1273		
		2662P-6 Small Seat		<b>OVERALL DIMENSIONS</b>			<b>SEAT DIMENSIONS</b>			<b>BACK DIMENSIONS</b>						
		<b>W</b>	<b>D</b>	<b>H</b>	<b>W</b>	<b>D</b>	<b>H</b>	<b>W</b>	<b>H</b>							
			25.5	25	39.5	20	19-20	16.5-20.5	19.5	21						
Ergonomic Features: C, E, H, M, N, Q, R, U		RTA 2														

DESCRIPTION	FEATURES	MODEL#	STANDARD TEXTILE GRADES																																					
			1	2	3	4	5	6	7	8	9	10	11	12																										
 <p><b>MB Drafting Stool - Task</b> COM Yardage: 1 Freight Class: 150 Product Weight (lbs.): 50 Cubic Feet Per Carton: 10.50</p>	<p><b>ADJUSTMENTS</b> (2) Pneumatic seat height</p>	<p>Ergonomic Features: C, E, H, M, N, Q, R, U</p>	<table border="1"> <tr> <td><b>2663-6</b></td> <td>987</td> <td>1013</td> <td>1034</td> <td>1064</td> <td>1108</td> <td>1123</td> <td>1161</td> <td>1233</td> <td>1268</td> <td>1336</td> <td>1428</td> <td>1541</td> </tr> <tr> <td colspan="13">2663P-6 Small Seat</td> </tr> </table>												<b>2663-6</b>	987	1013	1034	1064	1108	1123	1161	1233	1268	1336	1428	1541	2663P-6 Small Seat												
			<b>2663-6</b>	987	1013	1034	1064	1108	1123	1161	1233	1268	1336	1428	1541																									
			2663P-6 Small Seat																																					
			<table border="1"> <thead> <tr> <th colspan="3">OVERALL DIMENSIONS</th> <th colspan="3">SEAT DIMENSIONS</th> <th colspan="2">BACK DIMENSIONS</th> </tr> <tr> <th>W</th> <th>D</th> <th>H</th> <th>W</th> <th>D</th> <th>H</th> <th>W</th> <th>H</th> </tr> </thead> <tbody> <tr> <td>25.5</td> <td>25</td> <td>50</td> <td>20</td> <td>19-20</td> <td>24-34</td> <td>19.5</td> <td>21</td> </tr> </tbody> </table>			OVERALL DIMENSIONS			SEAT DIMENSIONS			BACK DIMENSIONS		W	D	H	W	D	H	W	H	25.5	25	50	20	19-20	24-34	19.5	21	<p><b>RTA 2</b> </p>										
OVERALL DIMENSIONS			SEAT DIMENSIONS			BACK DIMENSIONS																																		
W	D	H	W	D	H	W	H																																	
25.5	25	50	20	19-20	24-34	19.5	21																																	
 <p><b>MB Drafting Stool - Task</b> COM Yardage: 1 Freight Class: 150 Product Weight (lbs.): 44 Cubic Feet Per Carton: 10.50</p>	<p><b>ADJUSTMENTS</b> (2) Pneumatic seat height</p>	<p>Ergonomic Features: C, E, M, N, U</p>	<table border="1"> <tr> <td><b>2664-6</b></td> <td>897</td> <td>922</td> <td>943</td> <td>974</td> <td>1017</td> <td>1032</td> <td>1071</td> <td>1142</td> <td>1178</td> <td>1246</td> <td>1336</td> <td>1451</td> </tr> <tr> <td colspan="13">2664P-6 Small Seat</td> </tr> </table>												<b>2664-6</b>	897	922	943	974	1017	1032	1071	1142	1178	1246	1336	1451	2664P-6 Small Seat												
			<b>2664-6</b>	897	922	943	974	1017	1032	1071	1142	1178	1246	1336	1451																									
			2664P-6 Small Seat																																					
			<table border="1"> <thead> <tr> <th colspan="3">OVERALL DIMENSIONS</th> <th colspan="3">SEAT DIMENSIONS</th> <th colspan="2">BACK DIMENSIONS</th> </tr> <tr> <th>W</th> <th>D</th> <th>H</th> <th>W</th> <th>D</th> <th>H</th> <th>W</th> <th>H</th> </tr> </thead> <tbody> <tr> <td>20</td> <td>25</td> <td>50</td> <td>20</td> <td>19-20</td> <td>24-34</td> <td>19.5</td> <td>21</td> </tr> </tbody> </table>			OVERALL DIMENSIONS			SEAT DIMENSIONS			BACK DIMENSIONS		W	D	H	W	D	H	W	H	20	25	50	20	19-20	24-34	19.5	21	<p><b>RTA 2</b> </p>										
OVERALL DIMENSIONS			SEAT DIMENSIONS			BACK DIMENSIONS																																		
W	D	H	W	D	H	W	H																																	
20	25	50	20	19-20	24-34	19.5	21																																	
 <p><b>MB Task</b> COM Yardage: 1 Freight Class: 250 Product Weight (lbs.): 39 Cubic Feet Per Carton: 10.50</p>	<p><b>ADJUSTMENTS</b> (2) Pneumatic seat height (8) Seat depth</p>	<p>Ergonomic Features: C, E, M, N, U</p>	<table border="1"> <tr> <td><b>2665-6</b></td> <td>624</td> <td>649</td> <td>670</td> <td>701</td> <td>744</td> <td>759</td> <td>798</td> <td>870</td> <td>905</td> <td>973</td> <td>1063</td> <td>1178</td> </tr> <tr> <td colspan="13">2665P-6 Small Seat</td> </tr> </table>												<b>2665-6</b>	624	649	670	701	744	759	798	870	905	973	1063	1178	2665P-6 Small Seat												
			<b>2665-6</b>	624	649	670	701	744	759	798	870	905	973	1063	1178																									
			2665P-6 Small Seat																																					
			<table border="1"> <thead> <tr> <th colspan="3">OVERALL DIMENSIONS</th> <th colspan="3">SEAT DIMENSIONS</th> <th colspan="2">BACK DIMENSIONS</th> </tr> <tr> <th>W</th> <th>D</th> <th>H</th> <th>W</th> <th>D</th> <th>H</th> <th>W</th> <th>H</th> </tr> </thead> <tbody> <tr> <td>20</td> <td>25</td> <td>39.5</td> <td>20</td> <td>19-20</td> <td>16.5-20.5</td> <td>19.5</td> <td>21</td> </tr> </tbody> </table>			OVERALL DIMENSIONS			SEAT DIMENSIONS			BACK DIMENSIONS		W	D	H	W	D	H	W	H	20	25	39.5	20	19-20	16.5-20.5	19.5	21	<p><b>RTA 2</b> </p>										
OVERALL DIMENSIONS			SEAT DIMENSIONS			BACK DIMENSIONS																																		
W	D	H	W	D	H	W	H																																	
20	25	39.5	20	19-20	16.5-20.5	19.5	21																																	

LURAY



Luray is offered in three back heights.



Standard Black Nylon Base/Arms with Self Skinned Urethane Armcaps

Optional Aluminum Base/Arms with Self Skinned Urethane Armcaps

Optional Aluminum Base/Arms with Wood Armcaps

MECHANISMS OPTIONS

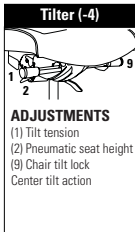

Ergonomic Features:  
A, B, C, M, N, S, U

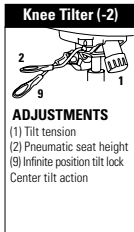

Ergonomic Features:  
A, B, C, J, M, N, U

STANDARD FEATURES

- Luray is designed for boardrooms, meeting rooms and executive offices.
- Luray offers a choice of finishes to match any environment: from durable nylon components to sophisticated polished aluminum and elegant wood trim.
- Three back heights are available, featuring horizontal sewing details.
- Stitch detail on edges of seat and back is discrete, using matched thread as standard.
- Choice of two mechanisms; tilter and knee-tilter.
- Standard with Global's high quality Soft Descent™ pneumatic lift which slowly and gently lowers the seat height of the chair making it easy to obtain the exact seat height you desire.
- Fixed loop arm design comes standard in Black fiberglass reinforced nylon with a self-skinned urethane (SSU) armcap; which is soft, durable and warm to the touch. The armcap overhangs the front and side of the arm so that chair to table contact is cushioned by the pliable edge.
- Five prong, injection molded, fiberglass reinforced, nylon medium rise base (**B7B**) with (**C1**) dual wheel carpet casters.
- Upholstery options: fabric, vinyl, leather or leather/mock leather combination.

OPTIONAL FEATURES

- Upholstery is available with exaggerated top stitch detail (heavier thread). Fourteen coordinating or contrasting colors may be selected. Please specify.
- For Additional caster options, please refer to the Arm and Caster section of the Price Book. Optional casters may be priced higher than the standard casters for your chair and the difference will be charged. Lower priced optional casters will not be credited.
- Please refer to "Cylinder Selection" section of the price book for additional cylinder options.
- For Memory Foam, specify (**MF**) and add \$84.

OPTION CODES

Please Add option codes in the following order:

- **Model number**  
**6460** Extended high back  
**6461** High back  
**6462** Medium back  
 Add (**LM**) to model number if ordering in leather or leather /mock leather.
- **Fabric**  
 Specify fabric code.
- **Mechanism**  
**(-4)** Tilter mechanism ..... **No Upcharge**  
**(-2)** Knee-tilt mechanism ..... **Add \$110**
- **Arms**  
**(SS)** Black nylon arms  
 w/SSU armcaps ..... **No Upcharge**  
**(AN)** Aluminum arms  
 w/SSU armcaps ..... **Add \$164**  
 Aluminum arms  
 w/Wood armcaps ..... **Add \$164**  
 Specify finish from the following:  
**(AB)** Absolute (AAM)  
**(B2)** Black (BKM)  
**(AE)** Cherry (ACM)  
**(EO)** English Oak (EOM)  
**(EC)** Espresso Café (ECM)  
**(HG)** Gray (HGM)  
**(AH)** Honey (AHM)  
**(TM)** Mahogany (TMM)  
**(AV)** Maple (AVM)  
**(MW)** Medium walnut (MWM)  
**(AT)** Night (ASM)  
**(SK)** Shaker Cherry (SKM)  
**(TF)** Fruitwood (TFM)  
**(W4)** Walnut (TWM)  
**(WR)** WC Cream (WTM)  
**(WH)** White (WHM)  
**(WC)** Winter Cherry (WCM)  
 (colors shown on website)
- **Base**  
**(B7)** Black nylon base.  
**(A7)** Polished aluminum ..... **Add \$121**
- **Casters**  
**(C1)** Dual wheel carpet casters.  
**(C9R)** Dual wheel  
 hard floor casters ..... **Add \$51**
- **Stitch detail**  
**(MS)** Color matched stitching  
 Decorative top stitch ..... **No Upcharge**  
**(XP)** Black                   **(XB)** Beige  
**(XG)** Copen               **(XA)** Graphite  
**(XK)** Mahogany       **(XJ)** Natural  
**(XH)** Navy               **(XD)** New Grey  
**(XF)** Nickel              **(XN)** Off White  
**(XL)** Rubytone       **(XI)** Scarlett  
**(XC)** Smoke           **(XE)** Taupe  
 (colors shown on website)
- **Seat foam**  
**(SF)** Standard foam  
**(MF)** Memory foam ..... **Add \$84**
- **Chair Assembly**  
**(SU)** Assembled in Box ..... **Add \$55**

EXAMPLE OF ORDER CODE:

6460	WA50	4	AH	A7	C1	MS	SF	SU
Model Number	Fabric	Mechanism	Arms	Base	Casters	Stitch Detail	Seat Foam	Chair Assembly

DESCRIPTION	FEATURES	MODEL#	STANDARD TEXTILE GRADES											
			1	2	3	4	5	6	7	8	9	10	11	12
 <p><b>Extended High Back</b> COM Yardage: 2.25 Freight Class: 250 Product Weight (lbs.): 46 Cubic Feet Per Carton: 14.75</p>			945	1009	1058	1133	1240	1289	1386	1539	1658	1790	2060	2348
			-	-	-	-	1182	1232	1330	1483	1600	1733	2004	2292
			<b>OVERALL DIMENSIONS</b>			<b>SEAT DIMENSIONS</b>			<b>BACK DIMENSIONS</b>					
			<b>W</b>	<b>D</b>	<b>H</b>	<b>W</b>	<b>D</b>	<b>H</b>	<b>W</b>	<b>H</b>				
			25	26.5	46	20	19	16.5-21.5	20	27.5				
			<b>RTA 1</b>											

DESCRIPTION	FEATURES	MODEL#	STANDARD TEXTILE GRADES											
			1	2	3	4	5	6	7	8	9	10	11	12
 <p><b>High Back</b> COM Yardage: 2 Freight Class: 150 Product Weight (lbs.): 44 Cubic Feet Per Carton: 13</p>			918	974	1018	1085	1179	1224	1310	1447	1552	1668	1909	2166
			-	-	-	-	1128	1174	1260	1396	1501	1618	1860	2116
			<b>OVERALL DIMENSIONS</b>			<b>SEAT DIMENSIONS</b>			<b>BACK DIMENSIONS</b>					
			<b>W</b>	<b>D</b>	<b>H</b>	<b>W</b>	<b>D</b>	<b>H</b>	<b>W</b>	<b>H</b>				
			25	26.5	42.5	20	19	16.5-21.5	20	24				
			<b>RTA 1</b>											

DESCRIPTION	FEATURES	MODEL#	STANDARD TEXTILE GRADES											
			1	2	3	4	5	6	7	8	9	10	11	12
 <p><b>Medium Back</b> COM Yardage: 1.75 Freight Class: 250 Product Weight (lbs.): 40 Cubic Feet Per Carton: 13</p>			890	941	979	1038	1121	1159	1234	1354	1446	1549	1759	1983
			-	-	-	-	1076	1115	1190	1309	1400	1503	1714	1939
			<b>OVERALL DIMENSIONS</b>			<b>SEAT DIMENSIONS</b>			<b>BACK DIMENSIONS</b>					
			<b>W</b>	<b>D</b>	<b>H</b>	<b>W</b>	<b>D</b>	<b>H</b>	<b>W</b>	<b>H</b>				
			25	26.5	39.5	20	19	16.5-21.5	20	21				
			<b>RTA 1</b>											

MALAGA®



model 3140-3 (TD)

model 3140-3 (TD/PSB)



**Memory Foam**  
Available, use code "MF" and Add 84.



model 3141-3

model 3141-3

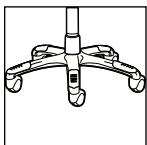

**Optional Base**  
Polished Aluminum base with black scuff tips. Specify "B2". Add \$121



**STANDARD FEATURES**

- A contoured molded foam seat, built-in lumbar support and an upholstered outer back shell is standard on all models.
- Standard with adjustable height T-arms with teardrop shaped urethane armcaps (TD).
- All models standard with a five-legged, injection molded "spider" base.
- Base and frame are available in Black (BK) Only.
- All models are shipped partially KD.
- C10 casters are standard.

**OPTIONAL FEATURES**

- To order a Malaga arm kit as a separate stand-alone item without a chair, use model number 3200 with the appropriate letter from the Arm Chart Price List for the arm style of your choice. Please refer to "Arms Selection" section of the price book.
- Available with an impact resistant polypropylene back shroud (Black Only) at no charge. Specify "PSB".

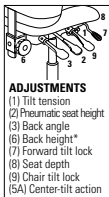
- Optional ballistic nylon outer back fabric available. Resistant to impact damage. Available in Black Only (BKB). Add \$15..
- Available with Memory Foam (MF). Add \$84.
- Optional Polished Aluminum base with black scuff tips. Specify "B2". Add \$121.
- Please refer to the "Casters Selection" section of the price book for caster options. Optional casters may be priced higher than the standard casters for your chair and the difference will be charged. Lower priced optional casters will not be credited.
- Please refer to "Cylinder Selection" section of the price book for additional cylinder options.
- For hard surface flooring please specify C10R. Add \$46.
- For fully assembled in box, please specify SU. Add \$55.
- For availability of chair series in Vinyl, please contact a Global Sales Representative.
- Not available in Leather.

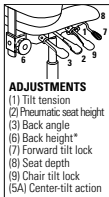
DESCRIPTION	FEATURES	MODEL#	STANDARD TEXTILE GRADES											
			1	2	3	4	5	6	7	8	9	10	11	12
 <p><b>HB Multi - Tilter</b> COM Yardage: 1.75 Freight Class: 150 Product Weight (lbs.): 49 Cubic Feet Per Carton: 9.25</p>	 <p><b>ADJUSTMENTS</b> (1) Tilt tension (2) Pneumatic seat height (3) Back angle (6) Back height* (7) Forward tilt lock (8) Seat depth (9) Chair tilt lock (SA) Center-tilt action</p>	<b>3140-3</b>	1062	1108	1145	1199	1280	1307	1377	1506	1569	1691	1856	2062
			<b>OVERALL DIMENSIONS</b>			<b>SEAT DIMENSIONS</b>			<b>BACK DIMENSIONS</b>					
			W	D	H	W	D	H	W	H				
	26	25	41	20	18	16.5-20.5	18.5	22.5-25						
 <p><b>LB Multi - Tilter</b> COM Yardage: 1.50 Freight Class: 150 Product Weight (lbs.): 47 Cubic Feet Per Carton: 9.25</p>	 <p><b>ADJUSTMENTS</b> (1) Tilt tension (2) Pneumatic seat height (3) Back angle (6) Back height* (7) Forward tilt lock (8) Seat depth (9) Chair tilt lock (SA) Center-tilt action</p>	<b>3141-3</b>	970	1007	1041	1088	1154	1179	1236	1351	1403	1506	1647	1826
			<b>OVERALL DIMENSIONS</b>			<b>SEAT DIMENSIONS</b>			<b>BACK DIMENSIONS</b>					
			W	D	H	W	D	H	W	H				
	26	24	37	20	18	16.5-20.5	18.5	19-21.5						

RTA 2



RTA 2



MAX™



model 5380-4 (TUN)



model 5382 (BK)



**Optional Base**  
Arched aluminum base available on models 5380-4 and 5381-4. Specify "B5". Add \$117.

STANDARD FEATURES

- Contoured cushions provide excellent lumbar back support.
- All models (except armchair style) are standard with a five-legged, arched metal base.
- Base and frame are standard with a Tungsten colored finish (**TUN**).
- **SSU** sculpted armcaps in Black Only.
- **C65** casters are standard.
- Model 5382 is standard with anti-tip glides.
- Base and frame available in Black finish (**BK**). No Charge. Please Specify.

OPTIONAL FEATURES

- Please refer to the "Casters Selection" section of the price book for caster options. Optional casters may be priced higher than the standard casters for your chair and the difference will be charged. Lower priced optional casters will not be credited.
- For hard surface flooring casters, specify **C65R** and Add \$51
- For availability of chair series in Vinyl please contact a Global Sales Representative. Not available in Crescent fabric.
- For fully assembled in box, please specify **SU**. Add \$55.

DESCRIPTION FEATURES MODEL# STANDARD TEXTILE GRADES



**HB Tilter**  
COM Yardage: 1.75  
Freight Class: 250  
Product Weight (lbs.): 38  
Cubic Feet Per Carton: 11.75

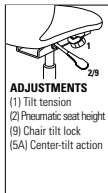

**ADJUSTMENTS**  
(1) Tilt tension  
(2) Pneumatic seat height  
(9) Chair tilt lock  
(5A) Center-tilt action

Ergonomic Features:  
A, B, C, M, N, S

MODEL#	1	2	3	4	5	6	7	8	9	10	11	12
5380-4	541	589	624	679	759	786	853	987	1048	1171	1334	1540

OVERALL DIMENSIONS			SEAT DIMENSIONS			BACK DIMENSIONS	
W	D	H	W	D	H	W	H
25.5	25.5	41	21.5	18	17-21	21	22

RTA 1



**MB Tilter**  
COM Yardage: 1.50  
Freight Class: 250  
Product Weight (lbs.): 36  
Cubic Feet Per Carton: 11.50

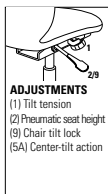

**ADJUSTMENTS**  
(1) Tilt tension  
(2) Pneumatic seat height  
(9) Chair tilt lock  
(5A) Center-tilt action

Ergonomic Features:  
A, B, C, M, N, S

MODEL#	1	2	3	4	5	6	7	8	9	10	11	12
5381-4	511	548	580	629	695	718	777	891	944	1048	1189	1365

OVERALL DIMENSIONS			SEAT DIMENSIONS			BACK DIMENSIONS	
W	D	H	W	D	H	W	H
25.5	24.5	37	21.5	18.5	17-21	21	18

RTA 1

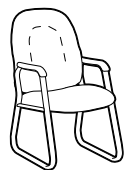

**Armchair - Cantilever base**  
COM Yardage: 1.50  
Freight Class: 300  
Product Weight (lbs.): 32  
Cubic Feet Per Carton: 17.50

Ergonomic Features:  
M, N

MODEL#	1	2	3	4	5	6	7	8	9	10	11	12
5382	424	465	497	543	611	634	694	805	860	963	1104	1281

OVERALL DIMENSIONS			SEAT DIMENSIONS			BACK DIMENSIONS	
W	D	H	W	D	H	W	H
25.5	26	36.5	21	18	18	21	18.5

RTA 00



**Armchair - 4 legged**  
COM Yardage: 1.50  
Freight Class: 300  
Product Weight (lbs.): 32  
Cubic Feet Per Carton: 17.50

Ergonomic Features:  
M, N

MODEL#	1	2	3	4	5	6	7	8	9	10	11	12
5383	528	570	600	648	715	740	799	910	967	1068	1209	1385

OVERALL DIMENSIONS			SEAT DIMENSIONS			BACK DIMENSIONS	
W	D	H	W	D	H	W	H
25.5	28.5	36.5	21	18	18	21	18.5

RTA 00



MIRAGE™



model 2790-4



model 2791-4





Standard with a polished aluminum loop arm with SSU armcap.

STANDARD FEATURES

- Ideal for management seating and meeting rooms, Mirage offers both function and style.
- There are no arm options for this series.
- Base and frame are standard in polished aluminum only.
- **C10** carpet casters are standard.

OPTIONAL FEATURES

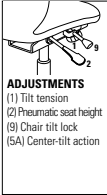
- For hard surface flooring casters, specify **C10R** and Add \$46.
- For fully assembled in box, please specify **SU**. Add \$55.

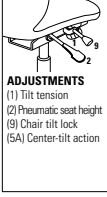
DESCRIPTION	FEATURES	MODEL#	STANDARD TEXTILE GRADES																																																																																					
			1	2	3	4	5	6	7	8	9	10	11	12																																																																										
 <p><b>HB Tilter</b> COM Yardage: 2 Freight Class: 250 Product Weight (lbs.): 26.5 Cubic Feet Per Carton: 20.25</p>	 <p><b>ADJUSTMENTS</b> (1) Tilt tension (2) Pneumatic seat height (9) Chair tilt lock (5A) Center-tilt action</p>	<p>Ergonomic Features: A, B, C, M, N, S</p>	<table border="1"> <tr> <td><b>2790-4</b></td> <td>916</td> <td>968</td> <td>1008</td> <td>1070</td> <td>1156</td> <td>1187</td> <td>1263</td> <td>1409</td> <td>1479</td> <td>1612</td> <td>1795</td> <td>2023</td> </tr> <tr> <td><b>2790LM-4</b></td> <td>-</td> <td>-</td> <td>-</td> <td>-</td> <td>1157</td> <td>-</td> <td>-</td> <td>1410</td> <td>1488</td> <td>1613</td> <td>1806</td> <td>2034</td> </tr> <tr> <td colspan="12">Leather/Mock Leather</td> </tr> <tr> <td colspan="3"><b>OVERALL DIMENSIONS</b></td> <td colspan="3"><b>SEAT DIMENSIONS</b></td> <td colspan="6"><b>BACK DIMENSIONS</b></td> </tr> <tr> <td><b>W</b></td> <td><b>D</b></td> <td><b>H</b></td> <td><b>W</b></td> <td><b>D</b></td> <td><b>H</b></td> <td colspan="2"><b>W</b></td> <td colspan="4"><b>H</b></td> </tr> <tr> <td>26.5</td> <td>26.5</td> <td>42.5</td> <td>20.5</td> <td>19</td> <td>16-20</td> <td colspan="2">20.5</td> <td colspan="4">24.5</td> </tr> </table>												<b>2790-4</b>	916	968	1008	1070	1156	1187	1263	1409	1479	1612	1795	2023	<b>2790LM-4</b>	-	-	-	-	1157	-	-	1410	1488	1613	1806	2034	Leather/Mock Leather												<b>OVERALL DIMENSIONS</b>			<b>SEAT DIMENSIONS</b>			<b>BACK DIMENSIONS</b>						<b>W</b>	<b>D</b>	<b>H</b>	<b>W</b>	<b>D</b>	<b>H</b>	<b>W</b>		<b>H</b>				26.5	26.5	42.5	20.5	19	16-20	20.5		24.5			
			<b>2790-4</b>	916	968	1008	1070	1156	1187	1263	1409	1479	1612	1795	2023																																																																									
			<b>2790LM-4</b>	-	-	-	-	1157	-	-	1410	1488	1613	1806	2034																																																																									
			Leather/Mock Leather																																																																																					
			<b>OVERALL DIMENSIONS</b>			<b>SEAT DIMENSIONS</b>			<b>BACK DIMENSIONS</b>																																																																															
<b>W</b>	<b>D</b>	<b>H</b>	<b>W</b>	<b>D</b>	<b>H</b>	<b>W</b>		<b>H</b>																																																																																
26.5	26.5	42.5	20.5	19	16-20	20.5		24.5																																																																																
			<b>RTA 00</b>																																																																																					
 <p><b>MB Tilter</b> COM Yardage: 1.75 Freight Class: 250 Product Weight (lbs.): 50 Cubic Feet Per Carton: 15.50</p>	 <p><b>ADJUSTMENTS</b> (1) Tilt tension (2) Pneumatic seat height (9) Chair tilt lock (5A) Center-tilt action</p>	<p>Ergonomic Features: A, B, C, M, N, S</p>	<table border="1"> <tr> <td><b>2791-4</b></td> <td>891</td> <td>937</td> <td>973</td> <td>1026</td> <td>1103</td> <td>1128</td> <td>1196</td> <td>1323</td> <td>1383</td> <td>1502</td> <td>1662</td> <td>1862</td> </tr> <tr> <td><b>2791LM-4</b></td> <td>-</td> <td>-</td> <td>-</td> <td>-</td> <td>1103</td> <td>-</td> <td>-</td> <td>1324</td> <td>1392</td> <td>1502</td> <td>1669</td> <td>1869</td> </tr> <tr> <td colspan="12">Leather/Mock Leather</td> </tr> <tr> <td colspan="3"><b>OVERALL DIMENSIONS</b></td> <td colspan="3"><b>SEAT DIMENSIONS</b></td> <td colspan="6"><b>BACK DIMENSIONS</b></td> </tr> <tr> <td><b>W</b></td> <td><b>D</b></td> <td><b>H</b></td> <td><b>W</b></td> <td><b>D</b></td> <td><b>H</b></td> <td colspan="2"><b>W</b></td> <td colspan="4"><b>H</b></td> </tr> <tr> <td>26</td> <td>25.5</td> <td>35.5</td> <td>19</td> <td>19</td> <td>16-20</td> <td colspan="2">19.5</td> <td colspan="4">17</td> </tr> </table>												<b>2791-4</b>	891	937	973	1026	1103	1128	1196	1323	1383	1502	1662	1862	<b>2791LM-4</b>	-	-	-	-	1103	-	-	1324	1392	1502	1669	1869	Leather/Mock Leather												<b>OVERALL DIMENSIONS</b>			<b>SEAT DIMENSIONS</b>			<b>BACK DIMENSIONS</b>						<b>W</b>	<b>D</b>	<b>H</b>	<b>W</b>	<b>D</b>	<b>H</b>	<b>W</b>		<b>H</b>				26	25.5	35.5	19	19	16-20	19.5		17			
			<b>2791-4</b>	891	937	973	1026	1103	1128	1196	1323	1383	1502	1662	1862																																																																									
			<b>2791LM-4</b>	-	-	-	-	1103	-	-	1324	1392	1502	1669	1869																																																																									
			Leather/Mock Leather																																																																																					
			<b>OVERALL DIMENSIONS</b>			<b>SEAT DIMENSIONS</b>			<b>BACK DIMENSIONS</b>																																																																															
<b>W</b>	<b>D</b>	<b>H</b>	<b>W</b>	<b>D</b>	<b>H</b>	<b>W</b>		<b>H</b>																																																																																
26	25.5	35.5	19	19	16-20	19.5		17																																																																																
			<b>RTA 00</b>																																																																																					

NOVELLO



Novello is offered in three frame finishes: Black, Fog and Ivory Clouds.

STANDARD MECHANISMS

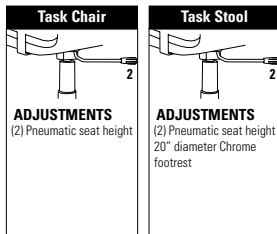

Ergonomic Features:  
C, M

Ergonomic Features:  
C, M

STANDARD FEATURES

- A revolutionary new task chair that can go anywhere - it requires no adjustments and provides exceptional comfort for any size user.
- Novello features a nylon polymer shell that flexes, allowing the seat to glide smoothly on a concealed track system. It is strong and durable, with clean lines and offers effective support.
- Chairs are molded with one-piece flexible shells; available in Black (BK), Fog Grey (FG) or Ivory Clouds (IC). Black is the base list price.
- Chairs with Black shells are standard with five prong, injection molded, fiberglass reinforced nylon Black base (B5) with (C82) dual wheel carpet casters.
- Chairs with Fog or Ivory Clouds shells are standard with a five prong, polished cast aluminum base with Black accents (BA) and black (C82) dual wheel carpet casters.
- Fog and Ivory Clouds chairs and Black models with an aluminum base come with a chrome gas cylinder.
- All models with arms are standard with Black armcaps.
- Standard with Global's high quality Soft Descent™ pneumatic lift which slowly and gently lowers the seat height of the chair making it easy to obtain the exact seat height you desire.
- Upholstery options: fabric, vinyl, or leather. Not available in leather/mock leather combination. Not available in Release fabric.

OPTIONAL FEATURES

- There are no different arm options for this series.
- For Additional caster options, please refer to the Arm and Caster section.
- Optional casters may be priced higher than the standard casters for your chair and the difference will be charged. Lower priced optional casters will not be credited.
- Please refer to "Cylinder Selection" section of the price book for additional cylinder options.

OPTION CODES

Please Add option codes in the following order:







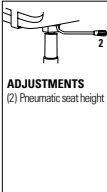

- **Model Number**  
**6400** Chair with arms  
**6401** Chair, armless  
**6402** Chair with arms, fully upholstered  
**6403** Chair, armless, fully upholstered  
**6410** Stool with arms  
**6411** Stool, armless  
**6412** Stool with arms, fully upholstered  
**6413** Stool, armless, fully upholstered
- **Fabric**  
Specify fabric code
- **Shell/arm color**  
**(BK)** Black shell..... **No Upcharge**  
**(FG)** Fog shell ..... **Add \$23**  
**(IC)** Cloud shell..... **Add \$23**
- **Armcaps (No Upcharge)**  
**(BP)** Black self-skinned urethane.  
**(FP)** Fog self-skinned urethane.  
**(CP)** Cloud self-skinned urethane.
- **Base**  
**(BB5)** Black nylon base..... **No Upcharge**  
**(FB5)** Fog nylon base..... **Add \$33**  
**(CB5)** Cloud nylon base ..... **Add \$33**  
**(BBA)** Polished aluminum w/Black accent..... **Add \$55**  
**(FBA)** Polished aluminum w/Fog accent..... **Add \$55**  
**(CBA)** Polished aluminum w/Cloud accent..... **Add \$55**
- **Adjustable Footring (stool models)**  
**(R3)** Black footring..... **No Upcharge**  
**(R4)** Polished aluminum footring..... **Add \$23**
- **Casters**  
**(C82)** Black dual wheel carpet casters ..... **No Upcharge**  
**(C82R)** Black dual wheel hard floor casters ..... **Add \$68**  
**(C82F)** Fog dual wheel carpet casters ..... **No Upcharge**  
**(C82FR)** Fog dual wheel hard floor casters..... **Add \$68**
- **Seat foam**  
**(SF)** Standard foam..... **No Upcharge**  
**(PF)** Extra plush cushion ..... **No Upcharge**
- **Chair Assembly**  
**(SU)** Assembled in Box ..... **\$55**

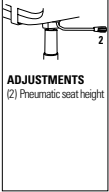

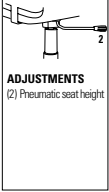
EXAMPLE OF ORDER CODE:

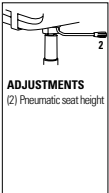
6400BK	WA50	EG	BK	AL	R3	C9R	SU
Model Number	Fabric	Shell/Arms	Armcaps	Base	Footring	Casters	Chair Assembly

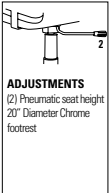
DESCRIPTION	FEATURES	MODEL#	STANDARD TEXTILE GRADES											
			1	2	3	4	5	6	7	8	9	10	11	12
 <p><b>Task Chair w/Arms</b> COM Yardage: 0.75 Freight Class: 150 Product Weight (lbs.): 40 Cubic Feet Per Carton: 8.25</p>	 <p><b>ADJUSTMENTS</b> (2) Pneumatic seat height</p> <p>Upholstered seat/ Polypropylene back</p> <p>Ergonomic Features: C, M</p>	<b>6400</b>	738	760	777	804	840	852	885	946	976	1033	1109	1206
		<b>OVERALL DIMENSIONS</b>			<b>SEAT DIMENSIONS</b>			<b>BACK DIMENSIONS</b>						
<b>W</b>	<b>D</b>	<b>H</b>	<b>W</b>	<b>D</b>	<b>H</b>	<b>W</b>		<b>H</b>						
25	22	36	18.5	18	16.5-21.5	20.5		18.5						

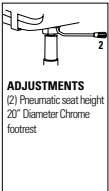
RTA 2

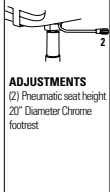
DESCRIPTION	FEATURES	MODEL#	STANDARD TEXTILE GRADES												
			1	2	3	4	5	6	7	8	9	10	11	12	
 <p><b>Armless Task Chair</b> COM Yardage: 0.75 Freight Class: 150 Product Weight (lbs.): 35 Cubic Feet Per Carton: 6.75</p>	 <p><b>ADJUSTMENTS</b> (2) Pneumatic seat height</p>	<b>6401</b>	667	689	705	731	765	781	814	866	905	949	1040	1136	
			<b>OVERALL DIMENSIONS</b>			<b>SEAT DIMENSIONS</b>			<b>BACK DIMENSIONS</b>						
			<b>W</b>	<b>D</b>	<b>H</b>	<b>W</b>	<b>D</b>	<b>H</b>	<b>W</b>	<b>H</b>					
			21.5	22	36	18.5	18	16.5-21.5	20.5	18.5					
			<b>RTA 2</b>												
 <p><b>Task Chair w/Arms</b> COM Yardage: 0.75 Freight Class: 150 Product Weight (lbs.): 40 Cubic Feet Per Carton: 8.25</p>	 <p><b>ADJUSTMENTS</b> (2) Pneumatic seat height</p>	<b>6402</b>	798	818	836	862	897	913	945	997	1036	1080	1171	1266	
			<b>OVERALL DIMENSIONS</b>			<b>SEAT DIMENSIONS</b>			<b>BACK DIMENSIONS</b>						
			<b>W</b>	<b>D</b>	<b>H</b>	<b>W</b>	<b>D</b>	<b>H</b>	<b>W</b>	<b>H</b>					
			25	22	36	18.5	17.5	16.5-21.5	20.5	18.5					
			<b>RTA 2</b>												
 <p><b>Armless Task Chair</b> COM Yardage: 0.75 Freight Class: 150 Product Weight (lbs.): 37 Cubic Feet Per Carton: 6.75</p>	 <p><b>ADJUSTMENTS</b> (2) Pneumatic seat height</p>	<b>6403</b>	733	755	772	797	832	848	881	933	972	1015	1106	1201	
			<b>OVERALL DIMENSIONS</b>			<b>SEAT DIMENSIONS</b>			<b>BACK DIMENSIONS</b>						
			<b>W</b>	<b>D</b>	<b>H</b>	<b>W</b>	<b>D</b>	<b>H</b>	<b>W</b>	<b>H</b>					
			21.5	22	36	18.5	17.5	16.5-21.5	20.5	18.5					
			<b>RTA 2</b>												
 <p><b>Task Stool w/Arms</b> COM Yardage: 0.75 Freight Class: 150 Product Weight (lbs.): 44 Cubic Feet Per Carton: 8.25</p>	 <p><b>ADJUSTMENTS</b> (2) Pneumatic seat height 20" Diameter Chrome footrest</p>	<b>6410</b>	847	870	886	912	946	963	995	1047	1086	1130	1221	1317	
			<b>OVERALL DIMENSIONS</b>			<b>SEAT DIMENSIONS</b>			<b>BACK DIMENSIONS</b>						
			<b>W</b>	<b>D</b>	<b>H</b>	<b>W</b>	<b>D</b>	<b>H</b>	<b>W</b>	<b>H</b>					
			25	22	46	18.5	18	24-34	20.5	18.5					
			<b>RTA 2</b>												
 <p><b>Armless Task Stool</b> COM Yardage: 0.75 Freight Class: 150 Product Weight (lbs.): 39 Cubic Feet Per Carton: 8.25</p>	 <p><b>ADJUSTMENTS</b> (2) Pneumatic seat height 20" Diameter Chrome footrest</p>	<b>6411</b>	776	798	814	840	874	890	923	975	1014	1058	1149	1245	
			<b>OVERALL DIMENSIONS</b>			<b>SEAT DIMENSIONS</b>			<b>BACK DIMENSIONS</b>						
			<b>W</b>	<b>D</b>	<b>H</b>	<b>W</b>	<b>D</b>	<b>H</b>	<b>W</b>	<b>H</b>					
			25	21.5	46	18.5	17.5	24-34	20.5	18.5					
			<b>RTA 2</b>												

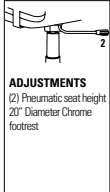
DESCRIPTION	FEATURES	MODEL#	STANDARD TEXTILE GRADES													
			1	2	3	4	5	6	7	8	9	10	11	12		
 <p><b>Task Stool w/Arms</b> COM Yardage: 0.75 Freight Class: 150 Product Weight (lbs.): 46 Cubic Feet Per Carton: 8.25</p>	 <p><b>ADJUSTMENTS</b> (2) Pneumatic seat height 20" Diameter Chrome footrest</p>	<b>6412</b>	907	929	946	973	1009	1022	1054	1116	1144	1200	1279	1375		
			<b>OVERALL DIMENSIONS</b>			<b>SEAT DIMENSIONS</b>			<b>BACK DIMENSIONS</b>							
			<b>W</b>	<b>D</b>	<b>H</b>	<b>W</b>	<b>D</b>	<b>H</b>	<b>W</b>	<b>H</b>						
			25	22	46	18.5	18	24-34	20.5	18.5						
			<b>RTA 2</b>													
 <p><b>Armless Task Stool</b> COM Yardage: 0.75 Freight Class: 150 Product Weight (lbs.): 39 Cubic Feet Per Carton: 8.25</p>	 <p><b>ADJUSTMENTS</b> (2) Pneumatic seat height 20" Diameter Chrome footrest</p>	<b>6413</b>	836	858	874	900	935	951	983	1035	1074	1118	1209	1304		
			<b>OVERALL DIMENSIONS</b>			<b>SEAT DIMENSIONS</b>			<b>BACK DIMENSIONS</b>							
			<b>W</b>	<b>D</b>	<b>H</b>	<b>W</b>	<b>D</b>	<b>H</b>	<b>W</b>	<b>H</b>						
			25	21.5	46	18.5	18	24-34	20.5	18.5						
			<b>RTA 2</b>													

OBUSFORME® COMFORT



model 1240-3



model 1241-3



**Memory Foam**  
Available, use code "MF"  
and Add \$84.



model 1261-3



STANDARD FEATURES

- ObusForme Comfort is the newest addition to the ObusForme family and is recommended by chiropractors worldwide.
- Features a new elastomeric back support system that provides impressive comfortable support with no pressure points along the spine.
- Standard with height and width adjustable forward swept arms with "sliding armcaps" (G3).
- Standard with a five-legged, injection molded reinforced nylon Black spider base.
- Standard seat is dual cushion with a soft top layer and a firmly supportive lower layer.
- Sliding seat depth is standard on all Knee-Tilter and Multi-Tilter models.
- Schukra™ depth adjustable lumbar support for personalized back support and comfort is standard on selected models.
- C65 dual wheel carpet casters are standard.
- All models are shipped partially **KD**.

OPTIONAL FEATURES

- Optional Memory Foam (MF) seats are available. This slow release foam molds to your contour and evenly distributes body weight. Please specify. Add \$84.
- An optional Polished Aluminum base with scuff resistant tips is available. Please specify (ALU). Add \$121.
- Please refer to the "Casters Selection" section of the price book for additional cylinder options. Optional casters may be priced higher than the standard casters for your chair and the difference will be charged. Lower priced optional casters will not be credited.
- Please refer to "Cylinder Selection" section of the price book for additional cylinder options.
- Please specify **C65R** for hard surface flooring. Add \$51.
- For fully assembled in box, please specify **SU**. Add \$55.

DESCRIPTION FEATURES MODEL# STANDARD TEXTILE GRADES



**HB Knee - Tilter**  
COM Yardage: 2.25  
Freight Class: 125  
Product Weight (lbs.): 67  
Cubic Feet Per Carton: 11

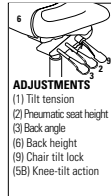

**ADJUSTMENTS**  
(1) Tilt tension  
(2) Pneumatic seat height  
(3) Back angle  
(6) Back height  
(9) Chair tilt lock  
(5B) Knee-tilt action

Ergonomic Features:  
A, B, C, D, E, G, H, J, M, N, Q, R, U

MODEL#	1	2	3	4	5	6	7	8	9	10	11	12
<b>1240-2</b>	1063	1128	1180	1258	1368	1407	1503	1687	1775	1945	2177	2465
1240P-2 Petite seat												

OVERALL DIMENSIONS			SEAT DIMENSIONS			BACK DIMENSIONS	
W	D	H	W	D	H	W	H
26	25	48.5	21	17.5-20	16.5-20.5	19	27.5

RTA 2



**HB Multi - Tilter**  
COM Yardage: 2.25  
Freight Class: 125  
Product Weight (lbs.): 69  
Cubic Feet Per Carton: 11

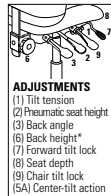

**ADJUSTMENTS**  
(1) Tilt tension  
(2) Pneumatic seat height  
(3) Back angle  
(6) Back height\*  
(7) Forward tilt lock  
(8) Seat depth  
(9) Chair tilt lock  
(5A) Center-tilt action

Ergonomic Features:  
A, B, C, D, E, F, G, H, M, N, Q, R, S, U

MODEL#	1	2	3	4	5	6	7	8	9	10	11	12
<b>1240-3</b>	908	974	1025	1103	1213	1252	1349	1532	1620	1791	2022	2310
1240P-3 Petite seat												

OVERALL DIMENSIONS			SEAT DIMENSIONS			BACK DIMENSIONS	
W	D	H	W	D	H	W	H
26	25	48	21	17.5-20	16-20	19	27

RTA 2



**MB Knee - Tilter**  
COM Yardage: 2  
Freight Class: 125  
Product Weight (lbs.): 67  
Cubic Feet Per Carton: 10.50

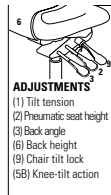









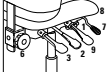

**ADJUSTMENTS**  
(1) Tilt tension  
(2) Pneumatic seat height  
(3) Back angle  
(6) Back height  
(9) Chair tilt lock  
(5B) Knee-tilt action

Ergonomic Features:  
A, B, C, D, E, G, H, J, M, N, Q, R, U

MODEL#	1	2	3	4	5	6	7	8	9	10	11	12
<b>1241-2</b>	1019	1078	1123	1192	1290	1325	1411	1574	1652	1804	2009	2265

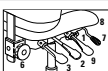
OVERALL DIMENSIONS			SEAT DIMENSIONS			BACK DIMENSIONS	
W	D	H	W	D	H	W	H
26	25	44.5	21	17.5-20	16.5-20.5	19.5	22-27.5

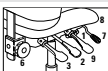
RTA 2

DESCRIPTION	FEATURES	MODEL#	STANDARD TEXTILE GRADES													
			1	2	3	4	5	6	7	8	9	10	11	12		
 <p><b>MB Multi -Tilter</b> COM Yardage: 2 Freight Class: 125 Product Weight (lbs.): 67 Cubic Feet Per Carton: 10.50</p>	 <p><b>ADJUSTMENTS</b> (1) Tilt tension (2) Pneumatic seat height (3) Back angle (6) Back height* (7) Forward tilt lock (8) Seat depth (9) Chair tilt lock (SA) Center-tilt action</p>	<b>1241-3</b>	863	920	967	1035	1133	1169	1253	1417	1495	1646	1851	2108		
			<b>OVERALL DIMENSIONS</b>			<b>SEAT DIMENSIONS</b>			<b>BACK DIMENSIONS</b>							
			<b>W</b>	<b>D</b>	<b>H</b>	<b>W</b>	<b>D</b>	<b>H</b>	<b>W</b>	<b>H</b>						
			26	25	44	21	17.5-20	16-20	19.5	22						
			<b>RTA 2</b>													
 <p><b>Armchair - Sled Base</b> COM Yardage: 1.75 Freight Class: 250 Product Weight (lbs.): 35 Cubic Feet Per Carton: 10</p>	<p>Ergonomic Features: A, B, C, D, E, F, G, H, M, N, Q, R, S, U</p>	<b>1246</b>	556	604	642	697	777	805	876	1008	1073	1196	1364	1574		
			<b>OVERALL DIMENSIONS</b>			<b>SEAT DIMENSIONS</b>			<b>BACK DIMENSIONS</b>							
			<b>W</b>	<b>D</b>	<b>H</b>	<b>W</b>	<b>D</b>	<b>H</b>	<b>W</b>	<b>H</b>						
			21	24	38	21	18	18	20	20.5						
			<b>RTA 2</b>													
 <p><b>Armchair - Sled Base</b> COM Yardage: 1.75 Freight Class: 150 Product Weight (lbs.): 40 Cubic Feet Per Carton: 10</p>	<p>Ergonomic Features: M, N</p>	<b>1247</b>	731	778	816	872	952	980	1050	1183	1248	1372	1540	1747		
			<b>OVERALL DIMENSIONS</b>			<b>SEAT DIMENSIONS</b>			<b>BACK DIMENSIONS</b>							
			<b>W</b>	<b>D</b>	<b>H</b>	<b>W</b>	<b>D</b>	<b>H</b>	<b>W</b>	<b>H</b>						
			24.5	24	38	21	18	18	20	20.5						
			<b>RTA 2</b>													
 <p><b>HB Multi -Tilter w/Schukra</b> COM Yardage: 2.25 Freight Class: 125 Product Weight (lbs.): 69 Cubic Feet Per Carton: 11</p>	 <p><b>ADJUSTMENTS</b> (1) Tilt tension (2) Pneumatic seat height (3) Back angle (6) Back height* (7) Forward tilt lock (8) Seat depth (9) Chair tilt lock (SA) Center-tilt action</p>	<b>1260-3</b>	1028	1094	1145	1223	1333	1372	1468	1652	1740	1910	2142	2430		
			<b>OVERALL DIMENSIONS</b>			<b>SEAT DIMENSIONS</b>			<b>BACK DIMENSIONS</b>							
			<b>W</b>	<b>D</b>	<b>H</b>	<b>W</b>	<b>D</b>	<b>H</b>	<b>W</b>	<b>H</b>						
			26	25	48	21	17.5-20	16-20	19.5	27-32.25						
			<b>RTA 2</b>													
 <p><b>MB Multi -Tilter w/Schukra</b> COM Yardage: 2 Freight Class: 125 Product Weight (lbs.): 67 Cubic Feet Per Carton: 10.50</p>	 <p><b>ADJUSTMENTS</b> (1) Tilt tension (2) Pneumatic seat height (3) Back angle (6) Back height* (7) Forward tilt lock (8) Seat depth (9) Chair tilt lock (SA) Center-tilt action</p>	<b>1261-3</b>	983	1042	1087	1156	1254	1289	1375	1537	1616	1768	1973	2229		
			<b>OVERALL DIMENSIONS</b>			<b>SEAT DIMENSIONS</b>			<b>BACK DIMENSIONS</b>							
			<b>W</b>	<b>D</b>	<b>H</b>	<b>W</b>	<b>D</b>	<b>H</b>	<b>W</b>	<b>H</b>						
			26	25	44	21	17.5-20	16-20	19.5	22						
			<b>RTA 2</b>													

OBUSFORME® COMFORT XL



model 1251-0

model 1252-8



**Memory Foam**  
Available, use code "MF" and Add \$84





STANDARD FEATURES





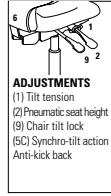

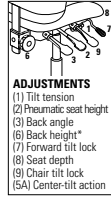

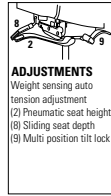
- ObusForme Comfort XL is the newest Addition to the ObusForme family and is recommended by chiropractors worldwide.
- All models provided Additional height and/or seat depth, design to meet the requirements of the large occupant chair.
- Features a elastomeric back support system that provides impressive comfortable support with no pressure points along the spine, with a compound curved back and seat.
- Standard seat foam is extra thick dual cushion with a soft top layer and a firmly supportive lower layer.
- Standard with height and width adjustable forward swept arms with "sliding armcaps" (G3).
- Standard with Global's high quality Soft Descent™ Pneumatic lift which slowly and gently lowers the seat height of the chair making it easy to obtain exactly the right seat height you desire.
- Vari - Width Adapter Plate (WA) is standard. Allows each arm to move outward an Additional 2" (for a total of 4" extra seat width) and locks with the use of an easy to maneuver lever.

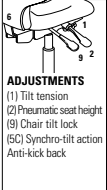
- Sliding seat depth is standard on all models.
- Vertical back height ratchet adjustment of 5 1/4", standard on all models.
- Standard five-legged, injection moulded, fiberglass reinforced nylon black spider base.
- C65 dual wheel carpet casters are standard.
- All models are rated for 400lbs.
- All models ship fully assembled in the box.

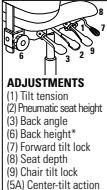

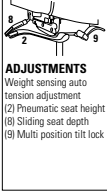

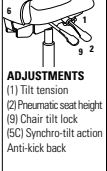

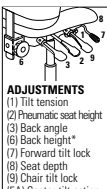

OPTIONAL FEATURES

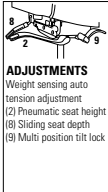
- Optional Memory Foam (MF) seats are available. This slow release foam molds to your contour and evenly distributes body weight. Please specify. Add \$84.
- Please specify C65R for hard surface flooring. Add \$51.
- Available in fabrics, vinyls, leather or leather/mock leather combination.

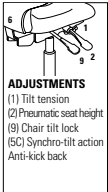
DESCRIPTION	FEATURES	MODEL#	STANDARD TEXTILE GRADES													
			1	2	3	4	5	6	7	8	9	10	11	12		
 <p><b>Extended Back Synchro - Tilter w/ Back Angle Adj.</b> COM Yardage: 2.75 Freight Class: 250 Product Weight (lbs.): 69 Cubic Feet Per Carton: 24.25</p>	 <p><b>ADJUSTMENTS</b> (1) Tilt tension (2) Pneumatic seat height (9) Chair tilt lock (5C) Synchro-tilt action Anti-kick back.</p>	1251-0	1391	1462	1518	1601	1722	1764	1868	2068	2163	2348	2600	2914		
		1251LM-0	-	-	-	-	1722	-	-	2068	-	2348	2600	2914		
		Leather/Mock Leather														
		<b>OVERALL DIMENSIONS</b>			<b>SEAT DIMENSIONS</b>			<b>BACK DIMENSIONS</b>								
W D H			W D H			W H										
28 26 53			23.5 19-21.5 17-21			22 31-36.25										
RTA 00																
 <p><b>Extended Back Multi - Tilter</b> COM Yardage: 2.75 Freight Class: 250 Product Weight (lbs.): 71 Cubic Feet Per Carton: 24.25</p>	 <p><b>ADJUSTMENTS</b> (1) Tilt tension (2) Pneumatic seat height (3) Back angle (6) Back height* (7) Forward tilt lock (8) Seat depth (9) Chair tilt lock (5A) Center-tilt action</p>	1251-3	1391	1462	1518	1601	1722	1764	1868	2068	2163	2348	2600	2914		
		1251LM-3	-	-	-	-	1722	-	-	2068	-	2348	2600	2914		
		Leather/Mock Leather														
		<b>OVERALL DIMENSIONS</b>			<b>SEAT DIMENSIONS</b>			<b>BACK DIMENSIONS</b>								
W D H			W D H			W H										
28 26 53			23.5 19-21.5 17-21			22 31-36.25										
RTA 00																
 <p><b>Extended Back Weight Sensing Synchro - Tilter</b> COM Yardage: 2.75 Freight Class: 250 Product Weight (lbs.): 66 Cubic Feet Per Carton: 24.25</p>	 <p><b>ADJUSTMENTS</b> Weight sensing auto tension adjustment (2) Pneumatic seat height (8) Sliding seat depth (9) Multi position tilt lock</p>	1251-8	1391	1462	1518	1601	1722	1764	1868	2068	2163	2348	2600	2914		
		1251LM-8	-	-	-	-	1722	-	-	2068	-	2348	2600	2914		
		Leather/Mock Leather														
		<b>OVERALL DIMENSIONS</b>			<b>SEAT DIMENSIONS</b>			<b>BACK DIMENSIONS</b>								
W D H			W D H			W H										
28 26 53			23.5 19-21.5 17-21			22 31-36.25										
RTA 00																

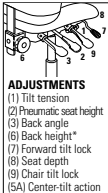
DESCRIPTION	FEATURES	MODEL#	STANDARD TEXTILE GRADES											
			1	2	3	4	5	6	7	8	9	10	11	12
 <p><b>High Back Synchro - Tilter w/ Back Angle Adj.</b> COM Yardage: 2.50 Freight Class: 250 Product Weight (lbs.): 65 Cubic Feet Per Carton: 22.25</p>	 <p><b>ADJUSTMENTS</b> (1) Tilt tension (2) Pneumatic seat height (9) Chair tilt lock (5C) Synchro-tilt action Anti-kick back</p>	<b>1252-0</b>	1330	1394	1446	1522	1630	1669	1764	1945	2033	2201	2429	2715
		<b>1252LM-0</b>	-	-	-	-	1630	-	-	1945	-	2201	2429	2715
		<b>OVERALL DIMENSIONS</b>			<b>SEAT DIMENSIONS</b>			<b>BACK DIMENSIONS</b>						
		<b>W D H</b>			<b>W D H</b>			<b>W H</b>						
		28 26 48.5			23.5 19-21.5 17-21			22 26.5-31.75						
		<b>RTA 00</b>												
 <p><b>High Back Multi - Tilter</b> COM Yardage: 2.50 Freight Class: 250 Product Weight (lbs.): 67 Cubic Feet Per Carton: 22.25</p>	 <p><b>ADJUSTMENTS</b> (1) Tilt tension (2) Pneumatic seat height (3) Back angle (6) Back height* (7) Forward tilt lock (8) Seat depth (9) Chair tilt lock (5A) Center-tilt action</p>	<b>1252-3</b>	1330	1394	1446	1522	1630	1669	1764	1945	2033	2201	2429	2715
		<b>1252LM-3</b>	-	-	-	-	1630	-	-	1945	-	2201	2429	2715
		<b>OVERALL DIMENSIONS</b>			<b>SEAT DIMENSIONS</b>			<b>BACK DIMENSIONS</b>						
		<b>W D H</b>			<b>W D H</b>			<b>W H</b>						
		28 26 48.5			23.5 19-21.5 17-21			22 26.5-31.75						
		<b>RTA 00</b>												
 <p><b>High Back Weight Sensing Synchro - Tilter</b> COM Yardage: 2.50 Freight Class: 250 Product Weight (lbs.): 62 Cubic Feet Per Carton: 22.25</p>	 <p><b>ADJUSTMENTS</b> Weight sensing auto tension adjustment (2) Pneumatic seat height (8) Sliding seat depth (9) Multi position tilt lock</p>	<b>1252-8</b>	1330	1394	1446	1522	1630	1669	1764	1945	2033	2201	2429	2715
		<b>1252LM-8</b>	-	-	-	-	1630	-	-	1945	-	2201	2429	2715
		<b>OVERALL DIMENSIONS</b>			<b>SEAT DIMENSIONS</b>			<b>BACK DIMENSIONS</b>						
		<b>W D H</b>			<b>W D H</b>			<b>W H</b>						
		28 26 48.5			23.5 19-21.5 17-21			22 26.5-31.75						
		<b>RTA 00</b>												
 <p><b>Mid Back Synchro - Tilter w/ Back Angle Adj.</b> COM Yardage: 1.75 Freight Class: 150 Product Weight (lbs.): 46 Cubic Feet Per Carton: 10.50</p>	 <p><b>ADJUSTMENTS</b> (1) Tilt tension (2) Pneumatic seat height (9) Chair tilt lock (5C) Synchro-tilt action Anti-kick back</p>	<b>1253-0</b>	1269	1334	1386	1462	1570	1609	1704	1885	1973	2141	2369	2654
		<b>1253LM-0</b>	-	-	-	-	1570	-	-	1885	-	2141	2369	2654
		<b>OVERALL DIMENSIONS</b>			<b>SEAT DIMENSIONS</b>			<b>BACK DIMENSIONS</b>						
		<b>W D H</b>			<b>W D H</b>			<b>W H</b>						
		28 26 44.5			23.5 19-21.5 17-21			22 22-27.25						
		<b>RTA 00</b>												
 <p><b>Mid Back Multi - Tilter</b> COM Yardage: 1.75 Freight Class: 150 Product Weight (lbs.): 41 Cubic Feet Per Carton: 10.50</p>	 <p><b>ADJUSTMENTS</b> (1) Tilt tension (2) Pneumatic seat height (3) Back angle (6) Back height* (7) Forward tilt lock (8) Seat depth (9) Chair tilt lock (5A) Center-tilt action</p>	<b>1253-3</b>	1269	1334	1386	1462	1570	1609	1704	1885	1973	2141	2369	2654
		<b>1253LM-3</b>	-	-	-	-	1570	-	-	1885	-	2141	2369	2654
		<b>OVERALL DIMENSIONS</b>			<b>SEAT DIMENSIONS</b>			<b>BACK DIMENSIONS</b>						
		<b>W D H</b>			<b>W D H</b>			<b>W H</b>						
		28 26 44.5			23.5 19-21.5 17-21			22 22-27.25						
		<b>RTA 00</b>												

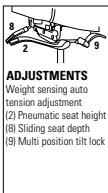

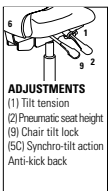

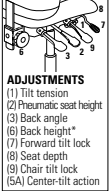
DESCRIPTION	FEATURES	MODEL#	STANDARD TEXTILE GRADES													
			1	2	3	4	5	6	7	8	9	10	11	12		
 <p><b>Mid Back Weight Sensing Synchro - Tilter</b> COM Yardage: 1.75 Freight Class: 150 Product Weight (lbs.): 35 Cubic Feet Per Carton: 10</p>	 <p><b>ADJUSTMENTS</b> Weight sensing auto tension adjustment (2) Pneumatic seat height (8) Sliding seat depth (9) Multi position tilt lock</p>	<b>1253-8</b>	1269	1334	1386	1462	1570	1609	1704	1885	1973	2141	2369	2654		
		<b>1253LM-8</b>	-	-	-	-	1570	-	-	1885	-	2141	2369	2654		
		Leather/Mock Leather														
		<b>OVERALL DIMENSIONS</b>			<b>SEAT DIMENSIONS</b>			<b>BACK DIMENSIONS</b>								
W D H			W D H			W H										
28 26 44.5			23.5 19-21.5 17-21			22 22-27.25										
<b>RTA 00</b>																
 <p><b>Extended Back Synchro - Tilter w/ Back Angle Adj.</b> COM Yardage: 1.75 Freight Class: 250 Product Weight (lbs.): 40 Cubic Feet Per Carton: 10</p>	 <p><b>ADJUSTMENTS</b> (1) Tilt tension (2) Pneumatic seat height (9) Chair tilt lock (5C) Synchro-tilt action Anti-kick back</p>	<b>1254-0</b>	1330	1400	1456	1541	1661	1703	1808	2007	2103	2287	2539	2853		
		<b>1254LM-0</b>	-	-	-	-	1661	-	-	2007	-	2287	2539	2853		
		Leather/Mock Leather														
		<b>OVERALL DIMENSIONS</b>			<b>SEAT DIMENSIONS</b>			<b>BACK DIMENSIONS</b>								
W D H			W D H			W H										
28 24.5 53			23.5 17-19.5 17-21			22 31-36.25										
<b>RTA 00</b>																
 <p><b>Extended Back Multi - Tilter</b> COM Yardage: 1.75 Freight Class: 250 Product Weight (lbs.): 49 Cubic Feet Per Carton: 10.50</p>	 <p><b>ADJUSTMENTS</b> (1) Tilt tension (2) Pneumatic seat height (3) Back angle (6) Back height* (7) Forward tilt lock (8) Seat depth (9) Chair tilt lock (5A) Center-tilt action</p>	<b>1254-3</b>	1330	1400	1456	1541	1661	1703	1808	2007	2103	2287	2539	2853		
		<b>1254LM-3</b>	-	-	-	-	1661	-	-	2007	-	2287	2539	2853		
		Leather/Mock Leather														
		<b>OVERALL DIMENSIONS</b>			<b>SEAT DIMENSIONS</b>			<b>BACK DIMENSIONS</b>								
W D H			W D H			W H										
28 24.5 53			23.5 17-19.5 17-21			22 31-36.25										
<b>RTA 00</b>																
 <p><b>Extended Back Weight Sensing Synchro - Tilter</b> COM Yardage: 1.75 Freight Class: 250 Product Weight (lbs.): 54 Cubic Feet Per Carton: 10.50</p>	 <p><b>ADJUSTMENTS</b> Weight sensing auto tension adjustment (2) Pneumatic seat height (8) Sliding seat depth (9) Multi position tilt lock</p>	<b>1254-8</b>	1330	1400	1456	1541	1661	1703	1808	2007	2103	2287	2539	2853		
		<b>1254LM-8</b>	-	-	-	-	1661	-	-	2007	-	2287	2539	2853		
		Leather/Mock Leather														
		<b>OVERALL DIMENSIONS</b>			<b>SEAT DIMENSIONS</b>			<b>BACK DIMENSIONS</b>								
W D H			W D H			W H										
28 24.5 53			23.5 17-19.5 17-21			22 31-36.25										
<b>RTA 00</b>																
 <p><b>High Back Synchro - Tilter w/ Back Angle Adj.</b> COM Yardage: 2.25 Freight Class: 250 Product Weight (lbs.): 67 Cubic Feet Per Carton: 11</p>	 <p><b>ADJUSTMENTS</b> (1) Tilt tension (2) Pneumatic seat height (9) Chair tilt lock (5C) Synchro-tilt action Anti-kick back</p>	<b>1255-0</b>	1269	1334	1386	1462	1570	1609	1704	1885	1973	2141	2369	2654		
		<b>1255LM-0</b>	-	-	-	-	1570	-	-	1885	-	2141	2369	2654		
		Leather/Mock Leather														
		<b>OVERALL DIMENSIONS</b>			<b>SEAT DIMENSIONS</b>			<b>BACK DIMENSIONS</b>								
W D H			W D H			W H										
28 24.5 48			23.5 17-19.5 17-21			22 26.5-31.75										
<b>RTA 00</b>																

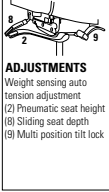
DESCRIPTION	FEATURES	MODEL#	STANDARD TEXTILE GRADES												
			1	2	3	4	5	6	7	8	9	10	11	12	
 <p><b>High Back Multi - Tilter</b> COM Yardage: 2.25 Freight Class: 250 Product Weight (lbs.): 69 Cubic Feet Per Carton: 11</p>	 <p><b>ADJUSTMENTS</b> (1) Tilt tension (2) Pneumatic seat height (3) Back angle (6) Back height* (7) Forward tilt lock (8) Seat depth (9) Chair tilt lock (5A) Center-tilt action</p>	<b>1255-3</b>	1269	1334	1386	1462	1570	1609	1704	1885	1973	2141	2369	2654	
		<b>1255LM-3</b>	-	-	-	-	1570	-	-	1885	-	2141	2369	2654	
		<b>OVERALL DIMENSIONS</b>			<b>SEAT DIMENSIONS</b>			<b>BACK DIMENSIONS</b>							
		<b>W</b>	<b>D</b>	<b>H</b>	<b>W</b>	<b>D</b>	<b>H</b>	<b>W</b>	<b>H</b>						
			28	24.5	48.5	23.5	17-19.5	17-21	22	26.5-31.75					
			<b>RTA 00</b>												

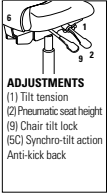
 <p><b>High Back Weight Sensing Synchro - Tilter</b> COM Yardage: 2 Freight Class: 250 Product Weight (lbs.): 67 Cubic Feet Per Carton: 10.50</p>	 <p><b>ADJUSTMENTS</b> Weight sensing auto tension adjustment (2) Pneumatic seat height (8) Sliding seat depth (9) Multi position tilt lock</p>	<b>1255-8</b>	1269	1334	1386	1462	1570	1609	1704	1885	1973	2141	2369	2654	
		<b>1255LM-8</b>	-	-	-	-	1570	-	-	1885	-	2141	2369	2654	
		<b>OVERALL DIMENSIONS</b>			<b>SEAT DIMENSIONS</b>			<b>BACK DIMENSIONS</b>							
		<b>W</b>	<b>D</b>	<b>H</b>	<b>W</b>	<b>D</b>	<b>H</b>	<b>W</b>	<b>H</b>						
			28	24.5	48.5	23.5	17-19.5	17-21	22	26.5-31.75					
			<b>RTA 00</b>												

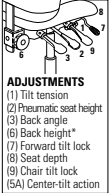
 <p><b>Mid Back Synchro - Tilter w/ Back Angle Adj.</b> COM Yardage: 2 Freight Class: 150 Product Weight (lbs.): 67 Cubic Feet Per Carton: 10.50</p>	 <p><b>ADJUSTMENTS</b> (1) Tilt tension (2) Pneumatic seat height (9) Chair tilt lock (5C) Synchro-tilt action Anti-kick back</p>	<b>1256-0</b>	1209	1273	1324	1400	1508	1549	1643	1825	1911	2080	2308	2593	
		<b>1256LM-0</b>	-	-	-	-	1508	-	-	1825	-	2080	2308	2593	
		<b>OVERALL DIMENSIONS</b>			<b>SEAT DIMENSIONS</b>			<b>BACK DIMENSIONS</b>							
		<b>W</b>	<b>D</b>	<b>H</b>	<b>W</b>	<b>D</b>	<b>H</b>	<b>W</b>	<b>H</b>						
			28	24.5	44.5	23.5	17-19.5	17-21	22	22-27.25					
			<b>RTA 00</b>												

 <p><b>Mid Back Multi - Tilter</b> COM Yardage: 2 Freight Class: 150 Product Weight (lbs.): 67 Cubic Feet Per Carton: 10.50</p>	 <p><b>ADJUSTMENTS</b> (1) Tilt tension (2) Pneumatic seat height (3) Back angle (6) Back height* (7) Forward tilt lock (8) Seat depth (9) Chair tilt lock (5A) Center-tilt action</p>	<b>1256-3</b>	1209	1273	1324	1400	1508	1549	1643	1825	1911	2080	2308	2593	
		<b>1256LM-3</b>	-	-	-	-	1508	-	-	1825	-	2080	2308	2593	
		<b>OVERALL DIMENSIONS</b>			<b>SEAT DIMENSIONS</b>			<b>BACK DIMENSIONS</b>							
		<b>W</b>	<b>D</b>	<b>H</b>	<b>W</b>	<b>D</b>	<b>H</b>	<b>W</b>	<b>H</b>						
			28	24.5	44.5	23.5	17-19.5	17-21	22	22-27.25					
			<b>RTA 00</b>												

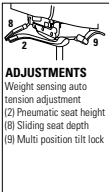
 <p><b>Mid Back Weight Sensing Synchro - Tilter</b> COM Yardage: 2 Freight Class: 150 Product Weight (lbs.): 67 Cubic Feet Per Carton: 10.50</p>	 <p><b>ADJUSTMENTS</b> Weight sensing auto tension adjustment (2) Pneumatic seat height (8) Sliding seat depth (9) Multi position tilt lock</p>	<b>1256-8</b>	1209	1273	1324	1400	1508	1549	1643	1825	1911	2080	2308	2593	
		<b>1256LM-8</b>	-	-	-	-	1508	-	-	1825	-	2080	2308	2593	
		<b>OVERALL DIMENSIONS</b>			<b>SEAT DIMENSIONS</b>			<b>BACK DIMENSIONS</b>							
		<b>W</b>	<b>D</b>	<b>H</b>	<b>W</b>	<b>D</b>	<b>H</b>	<b>W</b>	<b>H</b>						
			28	24.5	44.5	23.5	17-19.5	17-21	22	22-27.25					
			<b>RTA 00</b>												

PREFER



model 8458NA



model 8459



STANDARD FEATURES

- A sleek and comfortable all-purpose chair beautifully suited for conference, collaboration and training environments. Designed by Norbert Geelen.
- Swivel tilt function with no visible levers or mechanism.
- Standard with Asphalt or Alabaster frame and base, armless or with fixed arms.
- Integrated seat height adjustment lever is intuitive and easy to utilize.
- Dual wheel carpet casters are standard. Black (C82) casters standard on Asphalt models. Fog Grey (C82F) casters standard on Alabaster models.
- Not available in Crescent fabric.

OPTIONAL FEATURES

- Mesh is available in Black (MBK), Charcoal (MCH), Citrus (MCT), Pool Blue (MPB), Sand (MSD), and Stone (MST).
- Polished Aluminum (ALU) base available for Asphalt and Alabaster frames. Add \$124.
- Polished Aluminum (AL) arms available for Asphalt and Alabaster fixed arm models. Add \$124.
- For Alabaster base on the Asphalt frame, please specify (ABR). For Asphalt base on the Alabaster frame, please specify (ABT). Add \$55.
- Optional low black glides (G) are available at no upcharge.
- For hard floor surface casters, please specify (C82R) for Black and (C82FR) for Fog. Add \$68.
- For fully assembled in the box, please specify (SU). Add \$55.

DESCRIPTION FEATURES MODEL# STANDARD TEXTILE GRADES



Multi-task chair- Asphalt Base/Frame

COM Yardage: 1  
Freight Class: 250  
Product Weight (lbs.): 29  
Cubic Feet Per Carton: 9

Ergonomic Features:  
C, M

	1	2	3	4	5	6	7	8	9	10	11	12
8458	824	844	858	879	910	924	951	995	1029	1067	1144	1226

OVERALL DIMENSIONS

W D H

25.5 25 36

SEAT DIMENSIONS

W D H

20 20 17.5-22

BACK DIMENSIONS

W H

21 20

RTA 1



Multi-task chair, armless- Asphalt Base/Frame

COM Yardage: 0.75  
Freight Class: 250  
Product Weight (lbs.): 29  
Cubic Feet Per Carton: 9

Ergonomic Features:  
C, M

	1	2	3	4	5	6	7	8	9	10	11	12
8458NA	794	813	829	851	883	899	929	975	1011	1051	1133	1222

OVERALL DIMENSIONS

W D H

22 25 36

SEAT DIMENSIONS

W D H

20 20 17.5-22

BACK DIMENSIONS

W H

21 20

RTA 1



Drafting Stool- Asphalt Base/Frame

COM Yardage: 0.75  
Freight Class: 250  
Product Weight (lbs.): 36  
Cubic Feet Per Carton: 9

Ergonomic Features:  
C, M

	1	2	3	4	5	6	7	8	9	10	11	12
8458S	925	972	986	1008	1038	1052	1080	1124	1158	1195	1274	1356

OVERALL DIMENSIONS

W D H

25.5 25 42

SEAT DIMENSIONS

W D H

20 20 23-31

BACK DIMENSIONS

W H

21 20

RTA 1



Drafting stool, armless- Asphalt Base/Frame

COM Yardage: 0.75  
Freight Class: 250  
Product Weight (lbs.): 36  
Cubic Feet Per Carton: 9

Ergonomic Features:  
C, M

	1	2	3	4	5	6	7	8	9	10	11	12
8458NAS	922	942	957	980	1012	1027	1056	1104	1139	1179	1261	1349

OVERALL DIMENSIONS

W D H

25.5 25 42

SEAT DIMENSIONS

W D H

20 20 23-31

BACK DIMENSIONS

W H

21 20

RTA 1



DESCRIPTION	FEATURES	MODEL#	STANDARD TEXTILE GRADES											
			1	2	3	4	5	6	7	8	9	10	11	12
 <b>Multi-task chair- Alabaster Base/Frame</b> COM Yardage: 0.75 Freight Class: 250 Product Weight (lbs.): 29 Cubic Feet Per Carton: 9	Ergonomic Features: C, M	<b>8459</b>	902	920	936	957	989	1005	1033	1079	1114	1153	1233	1319
		<b>OVERALL DIMENSIONS</b>			<b>SEAT DIMENSIONS</b>			<b>BACK DIMENSIONS</b>						
		<b>W</b>	<b>D</b>	<b>H</b>	<b>W</b>	<b>D</b>	<b>H</b>	<b>W</b>	<b>H</b>					
			25.5	25	36	20	20	17.5-22	21	20				
						<b>RTA 1</b>								
 <b>Multi-task chair, armless- Alabaster Base/Frame</b> COM Yardage: 0.75 Freight Class: 250 Product Weight (lbs.): 29 Cubic Feet Per Carton: 9	Ergonomic Features: C, M	<b>8459NA</b>	871	891	907	931	965	980	1011	1059	1097	1139	1225	1317
		<b>OVERALL DIMENSIONS</b>			<b>SEAT DIMENSIONS</b>			<b>BACK DIMENSIONS</b>						
		<b>W</b>	<b>D</b>	<b>H</b>	<b>W</b>	<b>D</b>	<b>H</b>	<b>W</b>	<b>H</b>					
			22	25	36	20	20	17.5-22	21	20				
						<b>RTA 1</b>								
 <b>Drafting Stool- Alabaster Base/Frame</b> COM Yardage: 0.75 Freight Class: 250 Product Weight (lbs.): 36 Cubic Feet Per Carton: 9	Ergonomic Features: C, M	<b>8459S</b>	1030	1049	1064	1086	1118	1133	1161	1208	1243	1282	1362	1448
		<b>OVERALL DIMENSIONS</b>			<b>SEAT DIMENSIONS</b>			<b>BACK DIMENSIONS</b>						
		<b>W</b>	<b>D</b>	<b>H</b>	<b>W</b>	<b>D</b>	<b>H</b>	<b>W</b>	<b>H</b>					
			25.5	25	42	20	20	23-31	21	20				
						<b>RTA 1</b>								
 <b>Drafting stool, armless- Alabaster Base/Frame</b> COM Yardage: 0.75 Freight Class: 250 Product Weight (lbs.): 36 Cubic Feet Per Carton: 9	Ergonomic Features: C, M	<b>8459NAS</b>	1000	1020	1037	1060	1093	1109	1140	1188	1225	1266	1352	1442
		<b>OVERALL DIMENSIONS</b>			<b>SEAT DIMENSIONS</b>			<b>BACK DIMENSIONS</b>						
		<b>W</b>	<b>D</b>	<b>H</b>	<b>W</b>	<b>D</b>	<b>H</b>	<b>W</b>	<b>H</b>					
			25.5	25	42	20	20	23-31	21	20				
						<b>RTA 1</b>								

PRIORITY™



model 8490

model 8491

STANDARD FEATURES

- Priority's slim, sleek profile incorporates a compression molded wood back that follows and supports the ergonomic contours of the spine.
- Frames are standard in Black (BK).
- Soft touch self-skinned urethane (SSU) armcaps are available in Black only.
- All models are standard with a five prong, injection molded, fiberglass reinforced nylon Black base with (C1) dual wheel carpet casters.
- Standard pneumatic seat height, infinite tilt lock and tilt tension control.
- Upholstery options: fabric, vinyl or leather.
- Upholstery on outer back can be specified separately in a matching or contrasting material.





- Both the outer back and inner seat and back cushion can be upholstered and are available in fabric, vinyl, and leathers or in a combination of matching or contrasting fabric, vinyl and leather.\*\*This item may require a longer lead time.

SIDE CHAIR MODEL #8492

- Cantilever frame is made from tubular steel, standard in Black, optionally available in Aluminum (ALU) Chrome (CH) or Tungsten (TUN), please specify. Add \$189.
- Arms feature soft touch self-skinned urethane (SSU) armcaps in Black only.
- Glides are non-marking polypropylene suitable for both carpet and hard surface flooring.

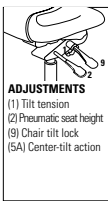
OPTIONAL FEATURES

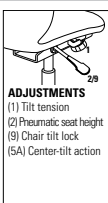
- Optional Polished Aluminum (ALU), Chrome (CH) and Tungsten (TUN) finishes are available at an upcharge. Please specify and Add \$189
- Soft touch self-skinned urethane armcaps are available in Black Only.
- Soft Casters (C9R) are available as an option. Please specify and Add \$51.

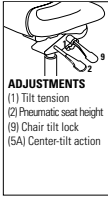
DESCRIPTION	FEATURES	MODEL#	STANDARD TEXTILE GRADES																											
			1	2	3	4	5	6	7	8	9	10	11	12																
 <p><b>HB Knee - Tilter</b> COM Yardage: 2.50 Freight Class: 250 Product Weight (lbs.): 54 Cubic Feet Per Carton: 22.75</p>	 <p><b>ADJUSTMENTS</b> (1) Tilt tension (2) Pneumatic seat height (9) Chair tilt lock (SA) Center-tilt action</p>	<p>Ergonomic Features: A, B, C, M, N, S</p>	<table border="1"> <tr> <td>8490</td><td>1142</td><td>1249</td><td>1288</td><td>1346</td><td>1430</td><td>1460</td><td>1532</td><td>1670</td><td>1737</td><td>1867</td><td>2041</td><td>2260</td> </tr> </table>												8490	1142	1249	1288	1346	1430	1460	1532	1670	1737	1867	2041	2260			
			8490	1142	1249	1288	1346	1430	1460	1532	1670	1737	1867	2041	2260															
			<p><b>OVERALL DIMENSIONS</b></p> <table border="1"> <tr> <th>W</th><th>D</th><th>H</th> </tr> <tr> <td>23.5</td><td>23.5</td><td>46</td> </tr> </table>			W	D	H	23.5	23.5	46	<p><b>SEAT DIMENSIONS</b></p> <table border="1"> <tr> <th>W</th><th>D</th><th>H</th> </tr> <tr> <td>19</td><td>18.5</td><td>18.5-23</td> </tr> </table>			W	D	H	19	18.5	18.5-23	<p><b>BACK DIMENSIONS</b></p> <table border="1"> <tr> <th>W</th><th>H</th> </tr> <tr> <td>19</td><td>27.5</td> </tr> </table>						W	H	19	27.5
			W	D	H																									
23.5	23.5	46																												
W	D	H																												
19	18.5	18.5-23																												
W	H																													
19	27.5																													
<b>RTA 00</b>																														
<p>RTA 00</p>																														
 <p><b>HB Tilter</b> COM Yardage: 2.75 Freight Class: 250 Product Weight (lbs.): 54 Cubic Feet Per Carton: 22.75</p>	 <p><b>ADJUSTMENTS</b> (1) Tilt tension (2) Pneumatic seat height (9) Chair tilt lock (SA) Center-tilt action</p>	<p>Ergonomic Features: A, B, C, M, N, S</p>	<table border="1"> <tr> <td>8490-4</td><td>1027</td><td>1077</td><td>1116</td><td>1175</td><td>1258</td><td>1287</td><td>1360</td><td>1499</td><td>1565</td><td>1695</td><td>1869</td><td>2087</td> </tr> </table>												8490-4	1027	1077	1116	1175	1258	1287	1360	1499	1565	1695	1869	2087			
			8490-4	1027	1077	1116	1175	1258	1287	1360	1499	1565	1695	1869	2087															
			<p><b>OVERALL DIMENSIONS</b></p> <table border="1"> <tr> <th>W</th><th>D</th><th>H</th> </tr> <tr> <td>23.5</td><td>23.5</td><td>46</td> </tr> </table>			W	D	H	23.5	23.5	46	<p><b>SEAT DIMENSIONS</b></p> <table border="1"> <tr> <th>W</th><th>D</th><th>H</th> </tr> <tr> <td>19</td><td>18.5</td><td>18.5-23</td> </tr> </table>			W	D	H	19	18.5	18.5-23	<p><b>BACK DIMENSIONS</b></p> <table border="1"> <tr> <th>W</th><th>H</th> </tr> <tr> <td>19</td><td>27.5</td> </tr> </table>						W	H	19	27.5
			W	D	H																									
23.5	23.5	46																												
W	D	H																												
19	18.5	18.5-23																												
W	H																													
19	27.5																													
<b>RTA 00</b>																														
<p>RTA 00</p>																														
 <p><b>MB Knee - Tilter</b> COM Yardage: 2.25 Freight Class: 250 Product Weight (lbs.): 49 Cubic Feet Per Carton: 17</p>	 <p><b>ADJUSTMENTS</b> (1) Tilt tension (2) Pneumatic seat height (9) Chair tilt lock (SA) Center-tilt action</p>	<p>Ergonomic Features: A, B, C, M, N, S</p>	<table border="1"> <tr> <td>8491</td><td>1090</td><td>1136</td><td>1172</td><td>1225</td><td>1301</td><td>1328</td><td>1395</td><td>1522</td><td>1583</td><td>1701</td><td>1861</td><td>2060</td> </tr> </table>												8491	1090	1136	1172	1225	1301	1328	1395	1522	1583	1701	1861	2060			
			8491	1090	1136	1172	1225	1301	1328	1395	1522	1583	1701	1861	2060															
			<p><b>OVERALL DIMENSIONS</b></p> <table border="1"> <tr> <th>W</th><th>D</th><th>H</th> </tr> <tr> <td>23.5</td><td>23.5</td><td>37</td> </tr> </table>			W	D	H	23.5	23.5	37	<p><b>SEAT DIMENSIONS</b></p> <table border="1"> <tr> <th>W</th><th>D</th><th>H</th> </tr> <tr> <td>19</td><td>18.5</td><td>18.5-23</td> </tr> </table>			W	D	H	19	18.5	18.5-23	<p><b>BACK DIMENSIONS</b></p> <table border="1"> <tr> <th>W</th><th>H</th> </tr> <tr> <td>19</td><td>19</td> </tr> </table>						W	H	19	19
			W	D	H																									
23.5	23.5	37																												
W	D	H																												
19	18.5	18.5-23																												
W	H																													
19	19																													
<b>RTA 00</b>																														
<p>RTA 00</p>																														

DESCRIPTION	FEATURES	MODEL#	STANDARD TEXTILE GRADES											
-------------	----------	--------	-------------------------	--	--	--	--	--	--	--	--	--	--	--



**MB Tilter**  
 COM Yardage: 2.50  
 Freight Class: 250  
 Product Weight (lbs.): 49  
 Cubic Feet Per Carton: 17

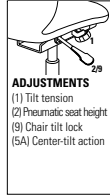

**ADJUSTMENTS**  
 (1) Tilt tension  
 (2) Pneumatic seat height  
 (3) Chair tilt lock  
 (5A) Center-tilt action

Ergonomic Features:  
 A, B, C, M, N, S

	1	2	3	4	5	6	7	8	9	10	11	12
--	---	---	---	---	---	---	---	---	---	----	----	----

<b>8491-4</b>	932	976	1012	1066	1142	1170	1235	1362	1424	1541	1701	1901
---------------	-----	-----	------	------	------	------	------	------	------	------	------	------

OVERALL DIMENSIONS			SEAT DIMENSIONS			BACK DIMENSIONS	
W	D	H	W	D	H	W	H

23.5	23.5	37	19	18.5	18.5-23	19	19
------	------	----	----	------	---------	----	----

**RTA 00**

ROMA®



model 1906



model 1908



**Optional Arms**  
A height adjustable arm is optionally available for task seating. Please specify (RA). Add \$61.

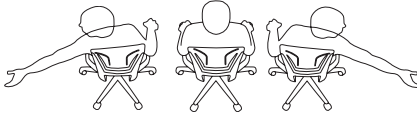

The Polypropylene Medium Back and the Upholstered Medium Back feature a flexible back construction that provides support, proper spinal alignment and comfort when moving or reaching in a seated position.







STANDARD FEATURES











- Flexible, elegant and affordable, Roma offers a family of seating with simple clean lines.
- The series includes nesting chairs, task seating and drafting stools, with and without arms.
- For Nesting chairs see page 194.
- Four back versions are available. Choose from Mesh, Upholstered, Flexible Polypropylene or Honeycomb Polypropylene back.
- All models upholstered in leather have two-piece seats with a radius towards the rear of the seat.
- Flexible polypropylene back chair features a built in lumbar support designed to move as you move and is available exclusively in black.
- The task chair upholstered back features a removable cover for on-site replacement and cleaning.
- Arms are durable fiberglass reinforced Nylon, fixed height. Armcaps are durable Polyurethane (SSU), soft and warm to the touch.
- Roma features an exclusive chair control mechanism which allows the chair back and arms to recline together while the chair seat moves just enough to ensure comfort.

- Features the new Soft Descent pneumatic technology to gently control the seat height for both an accurate and comfortable fit.
- Task chairs and stools are standard with a Black 5 prong fiberglass reinforced Nylon base.
- Nesting chairs are available in Tungsten (TUN) or Black (BLK).
- C1 casters are standard.











OPTIONAL FEATURES





- Breathable mesh back is available in six colors. Choose from Autumn Orange (AO), Spring Green (SG) Winter Grey (WG), Midnight Black (MB), Summer Blue (SB), Fall Burgundy (FB).
- An optional polished aluminum base is available at an upcharge. Specify (ALU). Add \$121.
- Please refer to "Cylinder Selection" section of the price book for additional cylinder options.
- Optional height adjustable arms are available, on task models. Please specify (RA). Add \$61.
- For hard surface flooring casters, please specify C9R. Add \$51.
- Available in fabric and leather with the EXCEPTION of Crescent, Imprint, and Renewal.
- For fully assembled in box, please specify SU. Add \$55.

DESCRIPTION	FEATURES	MODEL#	STANDARD TEXTILE GRADES												
			1	2	3	4	5	6	7	8	9	10	11	12	
 <p><b>Mesh MB - Armless Drafting Stool</b> COM Yardage: 1 Freight Class: 150 Product Weight (lbs.): 43 Cubic Feet Per Carton: 9.25</p>	<p>Ergonomic Features: B, C, M, N</p>	<p>RTA 2 </p>	1871	812	840	860	890	934	949	987	1059	1095	1161	1253	1367
			OVERALL DIMENSIONS			SEAT DIMENSIONS			BACK DIMENSIONS						
			W	D	H	W	D	H	W	H					
			19.5	23.5	48	19.5	18	24.5-34.5	18.5	19					
 <p><b>Polypropylene MB - Armless Drafting Stool</b> COM Yardage: 1 Freight Class: 150 Product Weight (lbs.): 43 Cubic Feet Per Carton: 9.25</p>	<p>Ergonomic Features: B, C, M, N</p>	<p>RTA 2 </p>	1872	812	840	860	890	934	949	987	1059	1095	1161	1253	1367
			OVERALL DIMENSIONS			SEAT DIMENSIONS			BACK DIMENSIONS						
			W	D	H	W	D	H	W	H					
			19.5	23.5	48	19.5	18	24.5-34.5	18.5	19					
 <p><b>Honeycomb MB - Armless Drafting Stool</b> COM Yardage: 1 Freight Class: 150 Product Weight (lbs.): 43 Cubic Feet Per Carton: 9.25</p>	<p>Ergonomic Features: B, C, M, N</p>	<p>RTA 2 </p>	1874	842	868	887	919	961	977	1014	1087	1123	1190	1282	1395
			OVERALL DIMENSIONS			SEAT DIMENSIONS			BACK DIMENSIONS						
			W	D	H	W	D	H	W	H					
			19.5	23.5	48	19.5	18	24.5-34.5	18.5	19					

DESCRIPTION	FEATURES	MODEL#	STANDARD TEXTILE GRADES											
			1	2	3	4	5	6	7	8	9	10	11	12
 <p><b>Mesh MB - Drafting Stool</b> COM Yardage: 1 Freight Class: 150 Product Weight (lbs.): 50 Cubic Feet Per Carton: 9.25</p>	Ergonomic Features: B, C, M, N	<b>1876</b>	863	889	909	941	983	999	1037	1109	1145	1212	1303	1417
			<b>OVERALL DIMENSIONS</b>			<b>SEAT DIMENSIONS</b>			<b>BACK DIMENSIONS</b>					
			<b>W</b>	<b>D</b>	<b>H</b>	<b>W</b>	<b>D</b>	<b>H</b>	<b>W</b>	<b>H</b>				
			25.5	23.5	48	19.5	18	24.5-34.5	18.5	19				
			<b>RTA 2</b>											
 <p><b>Polypropylene MB - Drafting Stool</b> COM Yardage: 1 Freight Class: 150 Product Weight (lbs.): 50 Cubic Feet Per Carton: 9.25</p>	Ergonomic Features: B, C, M, N	<b>1877</b>	863	889	909	941	983	999	1037	1109	1145	1212	1303	1417
			<b>OVERALL DIMENSIONS</b>			<b>SEAT DIMENSIONS</b>			<b>BACK DIMENSIONS</b>					
			<b>W</b>	<b>D</b>	<b>H</b>	<b>W</b>	<b>D</b>	<b>H</b>	<b>W</b>	<b>H</b>				
			25.5	23.5	48	19.5	18	24.5-34.5	18.5	19				
			<b>RTA 2</b>											
 <p><b>Honeycomb MB - Drafting Stool</b> COM Yardage: 1 Freight Class: 150 Product Weight (lbs.): 50 Cubic Feet Per Carton: 9.25</p>	Ergonomic Features: B, C, M, N	<b>1879</b>	894	919	939	971	1013	1028	1068	1139	1175	1242	1333	1448
			<b>OVERALL DIMENSIONS</b>			<b>SEAT DIMENSIONS</b>			<b>BACK DIMENSIONS</b>					
			<b>W</b>	<b>D</b>	<b>H</b>	<b>W</b>	<b>D</b>	<b>H</b>	<b>W</b>	<b>H</b>				
			25.5	23.5	48	19.5	18	24.5-34.5	18.5	19				
			<b>RTA 2</b>											
 <p><b>Honeycomb MB - Armless</b> COM Yardage: 1 Freight Class: 150 Product Weight (lbs.): 38 Cubic Feet Per Carton: 9.25</p>	Ergonomic Features: B, C, M, N	<b>1896</b>	655	681	702	733	776	792	830	902	937	1005	1096	1210
			<b>OVERALL DIMENSIONS</b>			<b>SEAT DIMENSIONS</b>			<b>BACK DIMENSIONS</b>					
			<b>W</b>	<b>D</b>	<b>H</b>	<b>W</b>	<b>D</b>	<b>H</b>	<b>W</b>	<b>H</b>				
			19.5	23.5	38	19.5	18	15-19	18.5	19				
			<b>RTA 2</b>											
 <p><b>Mesh MB - Armless</b> COM Yardage: 1 Freight Class: 150 Product Weight (lbs.): 38 Cubic Feet Per Carton: 9.25</p>	Ergonomic Features: B, C, M, N	<b>1901</b>	655	682	704	736	781	798	837	914	951	1022	1118	1236
			<b>OVERALL DIMENSIONS</b>			<b>SEAT DIMENSIONS</b>			<b>BACK DIMENSIONS</b>					
			<b>W</b>	<b>D</b>	<b>H</b>	<b>W</b>	<b>D</b>	<b>H</b>	<b>W</b>	<b>H</b>				
			19.5	23.5	36.25	19.5	18	15-19	18.5	19				
			<b>RTA 2</b>											



DESCRIPTION	FEATURES	MODEL#	STANDARD TEXTILE GRADES											
			1	2	3	4	5	6	7	8	9	10	11	12
 <b>Polypropylene MB - Armless</b> COM Yardage: 1 Freight Class: 150 Product Weight (lbs.): 36.25 Cubic Feet Per Carton: 9.25	Ergonomic Features: B, C, M, N	<b>1902</b>	655	682	704	736	781	798	837	914	951	1022	1118	1236
			<b>OVERALL DIMENSIONS</b>			<b>SEAT DIMENSIONS</b>			<b>BACK DIMENSIONS</b>					
			<b>W</b>	<b>D</b>	<b>H</b>	<b>W</b>	<b>D</b>	<b>H</b>	<b>W</b>	<b>H</b>				
			19.5	23.5	36.25	19.5	18	15-19	18.5	19				
			<b>RTA 2</b>											
 <b>Upholstered MB - Armless</b> COM Yardage: 1.75 Freight Class: 150 Product Weight (lbs.): 38 Cubic Feet Per Carton: 9.25	Ergonomic Features: B, C, M, N	<b>1903</b>	704	752	789	846	925	953	1024	1157	1221	1346	1514	1722
			<b>OVERALL DIMENSIONS</b>			<b>SEAT DIMENSIONS</b>			<b>BACK DIMENSIONS</b>					
			<b>W</b>	<b>D</b>	<b>H</b>	<b>W</b>	<b>D</b>	<b>H</b>	<b>W</b>	<b>H</b>				
			19.5	23.5	36.25	19.5	18	15-19	18.5	19				
			<b>RTA 2</b>											
 <b>Honeycomb MB - w/Arms</b> COM Yardage: 1 Freight Class: 150 Product Weight (lbs.): 45 Cubic Feet Per Carton: 9.25	Ergonomic Features: B, C, M, N	<b>1897</b>	700	726	746	777	821	835	874	946	981	1049	1140	1254
			<b>OVERALL DIMENSIONS</b>			<b>SEAT DIMENSIONS</b>			<b>BACK DIMENSIONS</b>					
			<b>W</b>	<b>D</b>	<b>H</b>	<b>W</b>	<b>D</b>	<b>H</b>	<b>W</b>	<b>H</b>				
			25.5	23.5	38	19.5	18	15-19	18.5	19				
			<b>RTA 2</b>											
 <b>Mesh MB - w/Arms</b> COM Yardage: 1 Freight Class: 150 Product Weight (lbs.): 45 Cubic Feet Per Carton: 9.25	Ergonomic Features: B, C, M, N	<b>1906</b>	700	727	749	780	827	843	882	957	995	1066	1161	1282
			<b>OVERALL DIMENSIONS</b>			<b>SEAT DIMENSIONS</b>			<b>BACK DIMENSIONS</b>					
			<b>W</b>	<b>D</b>	<b>H</b>	<b>W</b>	<b>D</b>	<b>H</b>	<b>W</b>	<b>H</b>				
			25.5	23.5	36.25	19.5	18	15-19	18.5	19				
			<b>RTA 2</b>											
 <b>Polypropylene MB - w/Arms</b> COM Yardage: 1 Freight Class: 150 Product Weight (lbs.): 45 Cubic Feet Per Carton: 9.25	Ergonomic Features: B, C, M, N	<b>1907</b>	700	727	749	780	827	843	882	957	995	1066	1161	1282
			<b>OVERALL DIMENSIONS</b>			<b>SEAT DIMENSIONS</b>			<b>BACK DIMENSIONS</b>					
			<b>W</b>	<b>D</b>	<b>H</b>	<b>W</b>	<b>D</b>	<b>H</b>	<b>W</b>	<b>H</b>				
			25.5	23.5	36.25	19.5	18	15-19	18.5	19				
			<b>RTA 2</b>											

DESCRIPTION	FEATURES	MODEL#	STANDARD TEXTILE GRADES													
			1	2	3	4	5	6	7	8	9	10	11	12		
 <p><b>Upholstered MB - w/Arms</b> COM Yardage: 1.75 Freight Class: 150 Product Weight (lbs.): 45 Cubic Feet Per Carton: 9.25</p>	<p>Ergonomic Features: B, C, M, N</p>	<p><b>RTA 2</b> </p>	1908	752	797	833	886	963	990	1057	1183	1245	1362	1522	1722	
			<b>OVERALL DIMENSIONS</b>			<b>SEAT DIMENSIONS</b>			<b>BACK DIMENSIONS</b>							
			<b>W</b>	<b>D</b>	<b>H</b>	<b>W</b>	<b>D</b>	<b>H</b>	<b>W</b>	<b>H</b>						
			25.5	23.5	36.25	19.5	18	16.5-20.5	18.5	19						
 <p><b>Upholstered Back Pad</b> COM Yardage: 1 Freight Class: 70 Product Weight (lbs.): 1.50 Cubic Feet Per Carton: 1.10</p>		<p><b>RTA 00</b> </p>	1909	140	167	189	222	267	283	323	398	436	506	603	723	
			<b>OVERALL DIMENSIONS</b>			<b>SEAT DIMENSIONS</b>			<b>BACK DIMENSIONS</b>							
			<b>W</b>	<b>D</b>	<b>H</b>	<b>W</b>	<b>D</b>	<b>H</b>	<b>W</b>	<b>H</b>						
			20.5	19	.38	21	18	18	20	20.5						

**SOFTCURVE™**



model 4691LM-3 (SC)



model 4696LM-2



**Optional Base**

Arched aluminum base available as an option on models that are standard with a black arched base. Specify "B5". Add \$140.



model 4698LM

**STANDARD FEATURES**

- European style with gathered upholstery, detailed stitching, built-in lumbar support and distinctive arch base.
- Executive and managerial models incorporate polished aluminum that accent both the arch base and fixed height loop arms with padded armrests.
- Standard Pneumatic seat height adjustment and tilt tension control on all models.
- Synchro-Tilter with Back Angle - synchronized seat and back movement with 2-to-1 ratio. Infinite tilt lock control. Back angle adjustment.
- Knee-Tilter: seat and back tilts from a pivot point near the front of the chair with infinite tilt lock. Back angle control.
- Multi-Tilter - Forward and rearward seat tilt with infinite tilt lock. Free-floating back angle control.
- All other models use a black urethane arch base and adjustable height forward swept arms with kidney shaped urethane armcaps (SC).
- Please Note: Loop arms will be the standard polished aluminum.
- **C1** casters are standard.

- Standard in Special Leather/Mock Leather (Grade 5). Not available in Fabric.

**OPTIONAL FEATURES**

- Optional ballistic style nylon outer back fabric available. Resistant to impact damage. Available in Black Only (BKB) Add \$15 (for models 4690LM-2 and 4691LM-2)
- Optional seat depth is available on models 4690LM-2, 4691LM-2 and 4691LM-3 Specify (MD). Add \$94.
- Optional Chrome (CHM) base is available on armchair model 4698LM only. Add \$100. Please specify. Optional Black (BLK) finish is available on the base on models 4696LM and 4697LM only. Add \$75. Please Specify.
- Please refer to "Cylinder Selection" section of the price book for additional cylinder options.
- For hard surface flooring casters Please Specify C9R, add \$51.
- For fully assembled in box, please specify **SU**. Add \$55.

**DESCRIPTION FEATURES MODEL# STANDARD TEXTILE GRADES**



**HB Synchro - Tilter** with back angle adjustment  
COM Yardage: 4.25  
Freight Class: 150  
Product Weight (lbs.): 56  
Cubic Feet Per Carton: 11.50

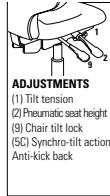

**ADJUSTMENTS**  
(1) Tilt tension  
(2) Pneumatic seat height  
(9) Chair tilt lock  
(SC) Synchro-tilt action  
Anti-kick back

Ergonomic Features:  
A, B, C, H, L, M, N

	1	2	3	4	5	6	7	8	9	10	11	12
<b>4690LM-0</b>	-	-	-	-	1221	-	-	1758	1945	2202	2636	3137

Leather/Mock Leather

OVERALL DIMENSIONS			SEAT DIMENSIONS			BACK DIMENSIONS	
W	D	H	W	D	H	W	H
26	27	45.5	20.5	18	17.5-21.5	20	26



**HB Knee - Tilter**  
COM Yardage: 4.25  
Freight Class: 150  
Product Weight (lbs.): 56  
Cubic Feet Per Carton: 11.50

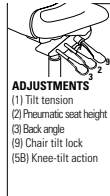

**ADJUSTMENTS**  
(1) Tilt tension  
(2) Pneumatic seat height  
(3) Back angle  
(9) Chair tilt lock  
(5B) Knee-tilt action

Ergonomic Features:  
A, B, C, G, H, J, M, N

	1	2	3	4	5	6	7	8	9	10	11	12
<b>4690LM-2</b>	-	-	-	-	1322	-	-	1859	2046	2305	2738	3239

Leather/Mock Leather

OVERALL DIMENSIONS			SEAT DIMENSIONS			BACK DIMENSIONS	
W	D	H	W	D	H	W	H
26	27	45.5	20.5	18	17.5-21.5	20	26



**HB Multi - Tilter**  
COM Yardage: 4.25  
Freight Class: 150  
Product Weight (lbs.): 56  
Cubic Feet Per Carton: 11.50

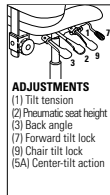

**ADJUSTMENTS**  
(1) Tilt tension  
(2) Pneumatic seat height  
(3) Back angle  
(7) Forward tilt lock  
(9) Chair tilt lock  
(5A) Center-tilt action







Ergonomic Features:  
A, B, C, F, G, H, M, N, S



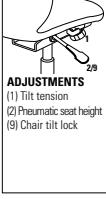
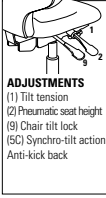

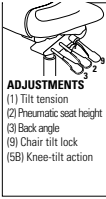

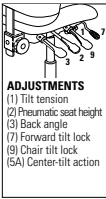

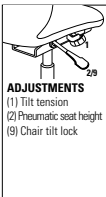
	1	2	3	4	5	6	7	8	9	10	11	12
<b>4690LM-3</b>	-	-	-	-	1221	-	-	1758	1945	2202	2636	3137

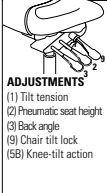

Leather/Mock Leather

OVERALL DIMENSIONS			SEAT DIMENSIONS			BACK DIMENSIONS	
W	D	H	W	D	H	W	H
26	27	45.5	20.5	18	17.5-21.5	20	20

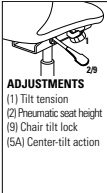

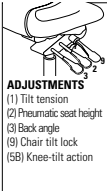
DESCRIPTION	FEATURES	MODEL#	STANDARD TEXTILE GRADES													
			1	2	3	4	5	6	7	8	9	10	11	12		
 <p><b>MB Tilter</b> COM Yardage: 4.25 Freight Class: 150 Product Weight (lbs.): 54 Cubic Feet Per Carton: 11.50</p>	 <p><b>ADJUSTMENTS</b> (1) Tilt tension (2) Pneumatic seat height (9) Chair tilt lock</p>	<b>4690LM-4</b> Leather/Mock Leather	-	-	-	-	1132	-	-	1668	1856	2114	2551	3049		
			<b>OVERALL DIMENSIONS</b>			<b>SEAT DIMENSIONS</b>			<b>BACK DIMENSIONS</b>							
			<b>W</b>	<b>D</b>	<b>H</b>	<b>W</b>	<b>D</b>	<b>H</b>	<b>W</b>	<b>H</b>						
			26	27	45.5	20.5	18	17.5-21.5	20	20						
			<b>RTA 2</b>													
 <p><b>MB Synchro - Tilter</b> with back angle adjustment COM Yardage: 3.75 Freight Class: 150 Product Weight (lbs.): 54 Cubic Feet Per Carton: 9.75</p>	 <p><b>ADJUSTMENTS</b> (1) Tilt tension (2) Pneumatic seat height (9) Chair tilt lock (5C) Synchro-tilt action Anti-kick back</p>	<b>4691LM-0</b> Leather/Mock Leather	-	-	-	-	1151	-	-	1688	1789	2133	2402	2843		
			<b>OVERALL DIMENSIONS</b>			<b>SEAT DIMENSIONS</b>			<b>BACK DIMENSIONS</b>							
			<b>W</b>	<b>D</b>	<b>H</b>	<b>W</b>	<b>D</b>	<b>H</b>	<b>W</b>	<b>H</b>						
			26	26	39.5	20.5	18	17.5-21.5	20	20						
			<b>RTA 2</b>													
 <p><b>MB Knee - Tilter</b> COM Yardage: 3.75 Freight Class: 150 Product Weight (lbs.): 54 Cubic Feet Per Carton: 9.75</p>	 <p><b>ADJUSTMENTS</b> (1) Tilt tension (2) Pneumatic seat height (3) Back angle (9) Chair tilt lock (5B) Knee-tilt action</p>	<b>4691LM-2</b> Leather/Mock Leather	-	-	-	-	1255	-	-	1793	1893	2236	2505	2947		
			<b>OVERALL DIMENSIONS</b>			<b>SEAT DIMENSIONS</b>			<b>BACK DIMENSIONS</b>							
			<b>W</b>	<b>D</b>	<b>H</b>	<b>W</b>	<b>D</b>	<b>H</b>	<b>W</b>	<b>H</b>						
			26	26	39.5	20.5	18	17.5-21.5	20	20						
			<b>RTA 2</b>													
 <p><b>MB Multi - Tilter</b> COM Yardage: 3.75 Freight Class: 150 Product Weight (lbs.): 54 Cubic Feet Per Carton: 9.75</p>	 <p><b>ADJUSTMENTS</b> (1) Tilt tension (2) Pneumatic seat height (3) Back angle (7) Forward tilt lock (9) Chair tilt lock (5A) Center-tilt action</p>	<b>4691LM-3</b> Leather/Mock Leather	-	-	-	-	1151	-	-	1688	1789	2133	2402	2843		
			<b>OVERALL DIMENSIONS</b>			<b>SEAT DIMENSIONS</b>			<b>BACK DIMENSIONS</b>							
			<b>W</b>	<b>D</b>	<b>H</b>	<b>W</b>	<b>D</b>	<b>H</b>	<b>W</b>	<b>H</b>						
			26	26	39.5	20.5	18	17.5-21.5	20	20						
			<b>RTA 1</b>													
 <p><b>MB Tilter</b> COM Yardage: 3.75 Freight Class: 150 Product Weight (lbs.): 54 Cubic Feet Per Carton: 9.75</p>	 <p><b>ADJUSTMENTS</b> (1) Tilt tension (2) Pneumatic seat height (9) Chair tilt lock</p>	<b>4691LM-4</b> Leather/Mock Leather	-	-	-	-	1062	-	-	1598	1699	2044	2314	2754		
			<b>OVERALL DIMENSIONS</b>			<b>SEAT DIMENSIONS</b>			<b>BACK DIMENSIONS</b>							
			<b>W</b>	<b>D</b>	<b>H</b>	<b>W</b>	<b>D</b>	<b>H</b>	<b>W</b>	<b>H</b>						
			26	26	39.5	20.5	18	17.5-21.5	20	20						
			<b>RTA 1</b>													

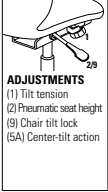
DESCRIPTION	FEATURES	MODEL#	STANDARD TEXTILE GRADES											
			1	2	3	4	5	6	7	8	9	10	11	12
 <p><b>Armchair</b> COM Yardage: 3.75 Freight Class: 250 Product Weight (lbs.): 42 Cubic Feet Per Carton: 13</p>	Ergonomic Features: H, M, N	4692LM	-	-	-	-	970	-	-	1506	1606	1951	2219	2661
			Leather/Mock Leather			<b>OVERALL DIMENSIONS</b>			<b>SEAT DIMENSIONS</b>			<b>BACK DIMENSIONS</b>		
			<b>W</b>	<b>D</b>	<b>H</b>	<b>W</b>	<b>D</b>	<b>H</b>	<b>W</b>	<b>H</b>				
			26	26.5	38.5	20.5	18	18	20	20.5				
			<b>RTA 00</b>											
 <p><b>MB Operator Armless</b> COM Yardage: 3.75 Freight Class: 150 Product Weight (lbs.): 40 Cubic Feet Per Carton: 9.75</p>	Ergonomic Features: C, F, G, M, N	4693LM-5	-	-	-	-	953	-	-	1491	1593	1935	2205	2648
			Leather/Mock Leather			<b>OVERALL DIMENSIONS</b>			<b>SEAT DIMENSIONS</b>			<b>BACK DIMENSIONS</b>		
			<b>W</b>	<b>D</b>	<b>H</b>	<b>W</b>	<b>D</b>	<b>H</b>	<b>W</b>	<b>H</b>				
			20.5	26	39	20.5	18	17-21	20	20				
			<b>RTA 1</b>											
 <p><b>HB Knee - Tilter Loop Arms</b> COM Yardage: 4.25 Freight Class: 150 Product Weight (lbs.): 58 Cubic Feet Per Carton: 13.25</p>	 <p><b>ADJUSTMENTS</b> (1) Tilt tension (2) Pneumatic seat height (3) Back angle (8) Chair tilt lock (5B) Knee-tilt action</p>	4696LM-2	-	-	-	-	1347	-	-	1883	2070	2328	2763	3265
			Leather/Mock Leather			<b>OVERALL DIMENSIONS</b>			<b>SEAT DIMENSIONS</b>			<b>BACK DIMENSIONS</b>		
			<b>W</b>	<b>D</b>	<b>H</b>	<b>W</b>	<b>D</b>	<b>H</b>	<b>W</b>	<b>H</b>				
			25	28	43.5	20.5	18	17-21	20	24				
			<b>RTA 1</b>											
 <p><b>HB Tilter Loop Arms</b> COM Yardage: 4.25 Freight Class: 250 Product Weight (lbs.): 45 Cubic Feet Per Carton: 13.25</p>	 <p><b>ADJUSTMENTS</b> (1) Tilt tension (2) Pneumatic seat height (9) Chair tilt lock (5A) Center-tilt action</p>	4696LM-4	-	-	-	-	1154	-	-	1691	1880	2138	2573	3072
			Leather/Mock Leather			<b>OVERALL DIMENSIONS</b>			<b>SEAT DIMENSIONS</b>			<b>BACK DIMENSIONS</b>		
			<b>W</b>	<b>D</b>	<b>H</b>	<b>W</b>	<b>D</b>	<b>H</b>	<b>W</b>	<b>H</b>				
			25	28	43	20.5	18	17-21	20	24				
			<b>RTA 1</b>											
 <p><b>MB Knee - Tilter Loop Arms</b> COM Yardage: 3.75 Freight Class: 150 Product Weight (lbs.): 55 Cubic Feet Per Carton: 11.50</p>	 <p><b>ADJUSTMENTS</b> (1) Tilt tension (2) Pneumatic seat height (3) Back angle (8) Chair tilt lock (5B) Knee-tilt action</p>	4697LM-2	-	-	-	-	1280	-	-	1815	1917	2261	2529	2973
			Leather/Mock Leather			<b>OVERALL DIMENSIONS</b>			<b>SEAT DIMENSIONS</b>			<b>BACK DIMENSIONS</b>		
			<b>W</b>	<b>D</b>	<b>H</b>	<b>W</b>	<b>D</b>	<b>H</b>	<b>W</b>	<b>H</b>				
			25	26	38	20.5	18	17.5-21.5	20	18.5				
			<b>RTA 1</b>											

DESCRIPTION	FEATURES	MODEL#	STANDARD TEXTILE GRADES											
			1	2	3	4	5	6	7	8	9	10	11	12
 <p><b>MB Tilter</b> Loop Arms COM Yardage: 3.75 Freight Class: 150 Product Weight (lbs.): 51 Cubic Feet Per Carton: 11.50</p>	 <p><b>ADJUSTMENTS</b> (1) Tilt tension (2) Pneumatic seat height (9) Chair tilt lock (5A) Center-tilt action</p>	<p><b>4697LM-4</b> Leather/Mock Leather</p>	<b>OVERALL DIMENSIONS</b>			<b>SEAT DIMENSIONS</b>			<b>BACK DIMENSIONS</b>					
			<b>W</b>	<b>D</b>	<b>H</b>	<b>W</b>	<b>D</b>	<b>H</b>	<b>W</b>	<b>H</b>				
			25	26	37.5	20.5	18	17.5-21.5	20	18.5				
			<p>Ergonomic Features: A, B, C, M, N, S</p> <p><b>RTA 00</b></p>											
 <p><b>Armchair</b> Loop Arms COM Yardage: 3.75 Freight Class: 250 Product Weight (lbs.): 42 Cubic Feet Per Carton: 17</p>		<p><b>4698LM</b> Leather/Mock Leather</p>	<b>OVERALL DIMENSIONS</b>			<b>SEAT DIMENSIONS</b>			<b>BACK DIMENSIONS</b>					
			<b>W</b>	<b>D</b>	<b>H</b>	<b>W</b>	<b>D</b>	<b>H</b>	<b>W</b>	<b>H</b>				
			25	26.5	37	20.5	18	18	20	18.5				
			<p>Ergonomic Features: H, M, N</p> <p><b>RTA 00</b></p>											

SOLAR



model 8456



model 8457



model 8456NA



model 8457NA

STANDARD FEATURES

- A sophisticated and versatile seating solution for conference and collaborative environments. Designed by Paul Brooks.
- One piece molded frame is extremely light (chair weighs 24 lbs) and exceeds BIFMA standard for commercial applications.
- Cascading forward seat surface and reverse edge profile provide better leg clearance and comfort.
- Integrated seat height adjustment lever is intuitive and easy to utilize.
- The under seat structure maintains the seamless and fluid aesthetic that defines Solar.
- All bases are standard with Black (C1) dual wheel carpet casters.

OPTIONAL FEATURES

- Mesh is available in Midnight (MDN), Storm (STM), and Dove (DVE).
- Polished Aluminum (ALU) base is available, please add \$121.
- Alabaster (ABR) base can be ordered on an Asphalt frame, please add \$55 list.
- Asphalt (APT) base on an Alabaster frame, please add \$55.
- Optional hard surface Black Glide (C7) is available at no up charge.
- For hard floor surface casters please specify C9R, please add \$51.

DESCRIPTION	FEATURES	MODEL#	STANDARD TEXTILE GRADES											
-------------	----------	--------	-------------------------	--	--	--	--	--	--	--	--	--	--	--



**MB Mesh Tilter - Asphalt Base/Frame**

COM Yardage: N/A  
 Freight Class: 250  
 Product Weight (lbs.): 24  
 Cubic Feet Per Carton: 9

Ergonomic Features:  
 C, M

MODEL#	1	2	3	4	5	6	7	8	9	10	11	12
8456	800	-	-	-	-	-	-	-	-	-	-	-

OVERALL DIMENSIONS			SEAT DIMENSIONS			BACK DIMENSIONS	
W	D	H	W	D	H	W	H

23.25	25	36	19.25	18	17-21	19	19
-------	----	----	-------	----	-------	----	----



**MB Mesh Tilter - Alabaster Base/Frame**

COM Yardage: N/A  
 Freight Class: 250  
 Product Weight (lbs.): 24  
 Cubic Feet Per Carton: 9

Ergonomic Features:  
 C, M

MODEL#	1	2	3	4	5	6	7	8	9	10	11	12
8457	877	-	-	-	-	-	-	-	-	-	-	-

OVERALL DIMENSIONS			SEAT DIMENSIONS			BACK DIMENSIONS	
W	D	H	W	D	H	W	H

23.25	25	36	19.25	18	17-21	19	19
-------	----	----	-------	----	-------	----	----



**MB Mesh Stool - Asphalt Base/Frame**

COM Yardage: N/A  
 Freight Class: 250  
 Product Weight (lbs.): 31  
 Cubic Feet Per Carton: 9











Ergonomic Features:  
 C, M

MODEL#	1	2	3	4	5	6	7	8	9	10	11	12
8456S	1020	-	-	-	-	-	-	-	-	-	-	-

OVERALL DIMENSIONS			SEAT DIMENSIONS			BACK DIMENSIONS	
W	D	H	W	D	H	W	H

23.25	25	42	19.25	18	22.5-30.5	19	19
-------	----	----	-------	----	-----------	----	----



DESCRIPTION	FEATURES	MODEL#	STANDARD TEXTILE GRADES											
			1	2	3	4	5	6	7	8	9	10	11	12
 <p><b>MB Mesh Stool - Alabaster Base/Frame</b>                      COM Yardage: N/A                      Freight Class: 250                      Product Weight (lbs.): 31                      Cubic Feet Per Carton: 9</p>	Ergonomic Features: C, M	8457S	1097	-	-	-	-	-	-	-	-	-	-	-
		<b>OVERALL DIMENSIONS</b> W D H			<b>SEAT DIMENSIONS</b> W D H			<b>BACK DIMENSIONS</b> W H						
		23.25	25	42	19.25	18	22.5-30.5	19	19					
		RTA 1												
 <p><b>MB Mesh Tilter - Asphalt Base/Frame</b>                      COM Yardage: N/A                      Freight Class: 250                      Product Weight (lbs.): 25                      Cubic Feet Per Carton: 9.50</p>	Ergonomic Features: C, M	8456NA	767	-	-	-	-	-	-	-	-	-	-	
		<b>OVERALL DIMENSIONS</b> W D H			<b>SEAT DIMENSIONS</b> W D H			<b>BACK DIMENSIONS</b> W H						
		23.25	25	36	19.25	18	17-21	19	19					
		RTA 1												
 <p><b>MB Mesh Tilter - Alabaster Base/Frame</b>                      COM Yardage: N/A                      Freight Class: 250                      Product Weight (lbs.): 25                      Cubic Feet Per Carton: 9.50</p>	Ergonomic Features: C, M	8457NA	844	-	-	-	-	-	-	-	-	-	-	
		<b>OVERALL DIMENSIONS</b> W D H			<b>SEAT DIMENSIONS</b> W D H			<b>BACK DIMENSIONS</b> W H						
		23.25	25	36	19.25	18	17-21	19	19					
		RTA 1												
 <p><b>MB Mesh Stool - Asphalt Base/Frame</b>                      COM Yardage: N/A                      Freight Class: 250                      Product Weight (lbs.): 29                      Cubic Feet Per Carton: 9.50</p>	Ergonomic Features: C, M	8456SNA	987	-	-	-	-	-	-	-	-	-	-	
		<b>OVERALL DIMENSIONS</b> W D H			<b>SEAT DIMENSIONS</b> W D H			<b>BACK DIMENSIONS</b> W H						
		23.25	25	42	19.25	18	22.5-30.5	19	19					
		RTA 1												
 <p><b>MB Mesh Stool - Alabaster Base/Frame</b>                      COM Yardage: N/A                      Freight Class: 250                      Product Weight (lbs.): 31                      Cubic Feet Per Carton: 9</p>	Ergonomic Features: C, M	8457SNA	1064	-	-	-	-	-	-	-	-	-	-	
		<b>OVERALL DIMENSIONS</b> W D H			<b>SEAT DIMENSIONS</b> W D H			<b>BACK DIMENSIONS</b> W H						
		23.25	25	42	19.25	18	22.5-30.5	19	19					
		RTA 1												



SOLO®



model 5227



model 5226

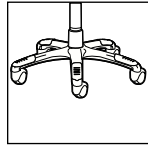

**Optional Base**  
Polished Aluminum base with black scuff tips. Specify "B2". Add \$117.

**STANDARD FEATURES**

- Contoured seat and back, waterfall seat edge and **SSU** armcaps provide extended comfort.
- All models (except armchairs) are standard with a five-legged, injection molded base.
- Frame is standard in Black (**BK**).
- Ganging Clamp 5233 used for models 5225 and 5226 sled base models. Can be used for Supra models 5332 and 5332L.
- Ganging Clamp 2755 For model 5226. Zinc plated.
- Specifications and pricing is for 1 chair.
- Armchair models are standard with Black (**BK**) glides.
- **C65** casters are standard.
- For availability of chair series in Vinyl, please contact a Global Sales Representative.
- Not available in Leather.

**OPTIONAL FEATURES**

- Frame is optional in a Tungsten (TUN) finish. No additional charge. Please Specify. (except on model 5224, Base is available in Black only.)

- Chrome upper finish with Black base available on models 5224, 5227 and 5228 or all Chrome on models 5225 and 5226. Add 10% of opening published grade price.
- Optional ballistic style nylon outer back fabric available. Resistant to impact damage. Available in Black Only (**BKB**) Add \$15.
- Vinyl Bumper Guard available with back edge vinyl bumper guard option (**VBG**). Add \$18.
- Non-marking (**NM**) glides are available at no charge to replace Black glides. Please Specify.
- Polished Aluminum base with black scuff tips. Specify "B2". Add \$121.
- Please refer to the "Casters Selection" section of the price book for caster options. Optional casters may be priced higher than the standard casters for your chair and the difference will be charged. Lower priced optional casters will not be credited.
- For hard surface flooring casters Please Specify **C65R**, add \$51.
- For fully assembled in box, please specify **SU**. Add \$55.

**DESCRIPTION FEATURES MODEL# STANDARD TEXTILE GRADES**



**Armchair**

COM Yardage: 1.25  
Freight Class: 250  
Product Weight (lbs.): 25  
Cubic Feet Per Carton: 10.13 (2 per carton)

Ergonomic Features:  
M, N

MODEL#	1	2	3	4	5	6	7	8	9	10	11	12
5225	313	345	372	412	468	488	538	630	676	761	879	1026

OVERALL DIMENSIONS			SEAT DIMENSIONS			BACK DIMENSIONS	
W	D	H	W	D	H	W	H
24	25	34	20	18	18	20	18

RTA 00

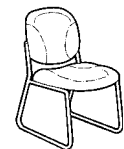

**Side Chair**

COM Yardage: 1.25  
Freight Class: 250  
Product Weight (lbs.): 21  
Cubic Feet Per Carton: 8.75 (2 per carton)

Ergonomic Features:  
M, N

MODEL#	1	2	3	4	5	6	7	8	9	10	11	12
5226	289	324	351	391	446	467	515	608	652	740	857	1026

OVERALL DIMENSIONS			SEAT DIMENSIONS			BACK DIMENSIONS	
W	D	H	W	D	H	W	H
22	25.5	34	20	18	18	20	18

RTA 00







**Ganging Clamp**

COM Yardage: N/A  
Freight Class: 70  
Product Weight (lbs.): .30  
Cubic Feet Per Carton: .10

MODEL#	1	2	3	4	5	6	7	8	9	10	11	12
2755	24	-	-	-	-	-	-	-	-	-	-	-

OVERALL DIMENSIONS			SEAT DIMENSIONS			BACK DIMENSIONS	
W	D	H	W	D	H	W	H
3	0.75	1	-	-	-	-	-

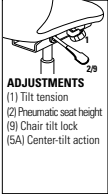

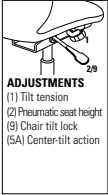
DESCRIPTION	FEATURES	MODEL#	STANDARD TEXTILE GRADES												
			1	2	3	4	5	6	7	8	9	10	11	12	
 <p><b>Ganging Clamps - Set of 2</b> COM Yardage: N/A Freight Class: 70 Product Weight: .20 Cubic Feet Per Carton: .04</p>		<b>5233</b>	22	-	-	-	-	-	-	-	-	-	-	-	-
			<b>OVERALL DIMENSIONS</b>			<b>SEAT DIMENSIONS</b>			<b>BACK DIMENSIONS</b>						
			<b>W</b>	<b>D</b>	<b>H</b>	<b>W</b>	<b>D</b>	<b>H</b>	<b>W</b>	<b>H</b>					
			.87	7.75	1.5										
															
 <p><b>HB Tilter</b> COM Yardage: 1.50 Freight Class: 150 Product Weight (lbs.): 41 Cubic Feet Per Carton: 10.13 (2 per carton)</p>	 <p><b>ADJUSTMENTS</b> (1) Tilt tension (2) Pneumatic seat height (9) Chair tilt lock (5A) Center-tilt action</p>		1	2	3	4	5	6	7	8	9	10	11	12	
		<b>5227</b>	461	500	533	578	646	670	730	844	896	999	1140	1317	
			<b>OVERALL DIMENSIONS</b>			<b>SEAT DIMENSIONS</b>			<b>BACK DIMENSIONS</b>						
			<b>W</b>	<b>D</b>	<b>H</b>	<b>W</b>	<b>D</b>	<b>H</b>	<b>W</b>	<b>H</b>					
			24	25.5	38	20	18.5	17.75-21.75	20	19.5					
			<b>RTA 00</b>												
 <p><b>LB Tilter</b> COM Yardage: 1.25 Freight Class: 250 Product Weight (lbs.): 32 Cubic Feet Per Carton: 10.13 (2 per carton)</p>	 <p><b>ADJUSTMENTS</b> (1) Tilt tension (2) Pneumatic seat height (9) Chair tilt lock (5A) Center-tilt action</p>		1	2	3	4	5	6	7	8	9	10	11	12	
		<b>5228</b>	415	448	473	514	570	591	640	732	776	863	980	1127	
			<b>OVERALL DIMENSIONS</b>			<b>SEAT DIMENSIONS</b>			<b>BACK DIMENSIONS</b>						
			<b>W</b>	<b>D</b>	<b>H</b>	<b>W</b>	<b>D</b>	<b>H</b>	<b>W</b>	<b>H</b>					
			24	24.5	34	20	18.5	17.75-21.75	20	17.5					
			<b>RTA 00</b>												

SORA™



model 6941



model 6942

**MECHANISM:**

Weight sensing synchro-tilter mechanism (-8)

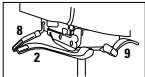

**ADJUSTMENTS**

- Weight sensing auto tension adjustment
- (2) Pneumatic seat height back/lumbar height
- (8) Sliding seat depth
- (9) Multi position tilt lock

**Ergonomic features:**

B, C, D, E, H, L, M, N, Q, R, U, V

**STANDARD FEATURES**

- Designed in three seat sizes and two back sizes to accommodate many body shapes.
- The upper back shape encourages free lateral movement.
- Features a weight sensing synchro-tilter mechanism (-8) that requires no tilt tension adjustment.
- Side activated sliding seat depth adjustment (**MD**).
- 4.4" adjustable lumbar area for personalized comfort and support is standard.
- Standard with Global's high quality Soft Descent™ 4" travel pneumatic lift which slowly and gently lowers the seat height of the chair making it easy to obtain the exact seat height you desire.
- 4.5" travel height adjustable arms.
- Five prong, injection molded, fiberglass reinforced nylon base with dual wheel casters.
- Sora is fully compliant with the latest BIFMA G1, GSA, and CGSB specifications.
- Frame is only available in Black.
- Upholstery options: fabric, vinyl or leather.

**OPTIONAL FEATURES**

- Height (E2), height and width adjustable (E3), and fully ergonomic arms (E4) are available.
- Fully ergonomic arms (E4) are height and width (1.4" travel) adjustable arms with sliding armcaps. Sliding armcaps travel 1" in width and 2" in depth, and articulate 20° inwards and 10° outwards to aim toward the keyboard or mouse area.
- Mesh backs are available in 24 brilliant Vue colors.

Please add option codes in the following order:



- **Model number**  
6941 High back  
6942 Medium back
- **Fabric**  
Specify fabric code
- **Mechanism**  
(-8) Weight sensing synchro-tilt
- **Arms**  
(E2) Height adjustable arms..... **No upcharge**  
(E3) Height and width adjustable arms..... **Add \$65**  
(E4) Fully ergonomic arms..... **Add \$155**
- **Base**  
(B7) Black nylon base..... **No upcharge**  
(A7) Polished aluminum base..... **Add \$121**
- **Casters**  
(C82) Dual wheel carpet casters..... **No upcharge**  
(C82R) Dual wheel hard floor casters..... **Add \$68**
- **Mesh** (colors shown on website)  
(VU10) Sandy Beach (VU23) Chartreuse  
(VU11) Desert Sand (VU26) Pool Blue  
(VU12) Orange Sunset (VU28) Sky  
(VU13) Chocolate Fountain (VU32) Primary Blue  
(VU14) Arctic Blue (VU34) Tangerine  
(VU15) Quarry Grey (VU37) Paprika  
(VU16) Tidal Wave (VU40) Grain  
(VU17) Ivy Moss (VU43) Yellow  
(VU18) Red Rose (VU55) Silver Grey  
(VU19) Coal Black (VU63) Silver  
(VU20) White (VU65) Hot Pink  
(VU21) Lime (VU70) Red Mittens
- **Seat Size**  
(P) Petite seat, 17" wide  
(STAN) Standard seat, 18.5" wide  
(GS) Generous seat, 19.5" wide
- **Cylinder (No Upcharge)**  
(4L) Standard (4")  
(5L) High (5")  
(4S) Short (4"). Seat height: 14.8" - 18.7"  
Seat height range achieved using (C1) casters.

**EXAMPLE SORA ORDER CODE**

6942	-HD08	-8	-E4	-A7	-C82	-VU32	-STAN	-4L
Model #	Fabric	Mechanism	Arm	Base	Casters	Mesh	Seat	Cylinder

Sora recommended dimensional information: based on measurements with weight sensing synchro-tilter mechanism				
	Distance between arms (pivot not included)	Standard arm height	Seat depth range	Standard seat height
<b>Petite seat (P)</b> Soft Descent 4" lift & (E4) arm	14.7" - 17.5" = 2.8" adjustment	7" - 11.5"	15.5" - 18.5"	16.1" - 20.1"
<b>Standard seat (STAN)</b> Soft Descent 4" lift & (E4) arm	16.2" - 19" = 2.8" adjustment		16.5" - 19.5"	
<b>Generous seat (GS)</b> Soft Descent 4" lift & (E4) arm	17.2" - 20" = 2.8" adjustment		17.5" - 19.75"	

Measurements shown are measured to the requirements of BIFMA G1-2013 / CGSB 44.232-2008.

DESCRIPTION	FEATURES	MODEL#	STANDARD TEXTILE GRADES											
			1	2	3	4	5	6	7	8	9	10	11	12
 <p><b>HB Weight Sensing Synchro-Tilter</b>                      COM Yardage: 1                      Freight Class: 150                      Product Weight (lbs.): 62                      Cubic Feet Per Carton: 13.50</p>		<b>6941</b>	1010	1037	1057	1087	1130	1151	1189	1252	1299	1353	1463	1579
			<b>OVERALL DIMENSIONS</b>			<b>SEAT DIMENSIONS</b>			<b>BACK DIMENSIONS</b>					
				<b>W</b>	<b>D</b>	<b>H</b>	<b>W</b>	<b>D</b>	<b>H</b>	<b>W</b>	<b>H</b>			
				25	24	42.5	18.5	16.5-19.5	16.1-20.1	18.5	26			
				<b>RTA 1</b>			1 per carton							
 <p><b>MB Weight Sensing Synchro-Tilter</b>                      COM Yardage: 1                      Freight Class: 150                      Product Weight (lbs.): 60                      Cubic Feet Per Carton: 13.50</p>		<b>6942</b>	969	995	1016	1046	1089	1110	1149	1212	1259	1313	1423	1540
			<b>OVERALL DIMENSIONS</b>			<b>SEAT DIMENSIONS</b>			<b>BACK DIMENSIONS</b>					
				<b>W</b>	<b>D</b>	<b>H</b>	<b>W</b>	<b>D</b>	<b>H</b>	<b>W</b>	<b>H</b>			
				25	24	40.5	18.5	16.5-19.5	16.1-20.1	18.5	24			
				<b>RTA 1</b>			1 per carton							

SPRITZ™



Spritz is offered in two back heights, with or without an optional lumbar support

MECHANISMS OPTIONS

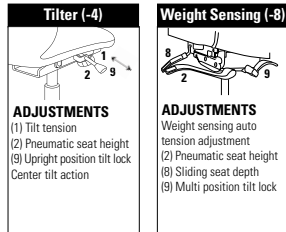

**Ergonomic Features:**  
A, B, C, D, E, H, M, N, Q, S, U

**Ergonomic Features:**  
A, B, C, E, H, L, M, N, Q, U

SPRITZ NESTING/MULTI-PURPOSE CHAIRS



For Spritz Nesting/Multi-Purpose chairs, please refer to Multi-Purpose section of price book.

STANDARD FEATURES

- An exceptionally comfortable chair series featuring a sophisticated, translucent mesh and models for all applications.
- Side activated sliding seat depth adjustment (**MD**) is standard on weight sensing synchro tilter control mechanism.
- Standard with height adjustable, forward swept arms and sliding armcaps (**G4**).
- Standard with Global's high quality Soft Descent™ pneumatic lift which slowly and gently lowers the seat height of the chair making it easy to obtain the exact seat height you desire.
- Five prong, injection molded, fiberglass reinforced nylon Black base with **C10** dual wheel carpet casters.
- Seat and headrest (where applicable) can be upholstered in fabric, vinyl or leather.
- Models can be ordered in Leather using appropriate grade. No leather/mock leather combination available.

OPTIONAL FEATURES

- For additional caster options, please refer to the Arm and Caster section.
- Optional casters may be priced higher than the standard casters for your chair and the difference will be charged. Lower priced optional casters will not be credited.

OPTION CODES

Please add option codes in the following order:

- **Model number**  
**6760** Task Chair w/Adjustable Headrest  
**6761** Task Chair
- Add **(-4)** to model number if ordering Tilter mechanism  
Add **(-8)** to model number if ordering Weight Sensing Synchro-Tilter mechanism
- **Fabric**  
Specify fabric code for seat.
- **Arms**  
**(G4)** Black nylon arms w/SSU armcaps..... **Standard**
- **Lumbar Pad Option**  
**(LSP)** Lumbar Pad..... **Add \$28**
- **Base**  
**(BK)** Black nylon base..... **Standard**  
**(M2)** Steel Chrome base..... **Add \$45**
- **Casters**  
**(C10)** Dual wheel carpet casters ..... **Standard**  
**(C10R)** Dual wheel hard floor casters..... **Add \$46**
- **Mesh Back**  
**(U1)** Black  
**(U2)** Burgundy  
**(U3)** Blue  
**(U4)** Green  
(colors shown on website)
- **Vari-Width**  
(WA) Width adjustable arm extensions..... **Add \$62**
- **Chair Assembly**  
**(-SU)** Assembled in Box..... **Add \$55**

EXAMPLE OF ORDER CODE:

6760-4	WA50	G4	LSP	SD	C10	U2	WA	SU
Model Number	Fabric	Arms	Lumbar Pad	Base	Casters	Mesh Back	Vari-Width	Chair Assembly

DESCRIPTION

FEATURES

MODEL#

STANDARD TEXTILE GRADES



Tilter w/Adjustable Headrest

COM Yardage: 1  
Freight Class: 150  
Product Weight (lbs.): 49  
Cubic Feet Per Carton: 11

	1	2	3	4	5	6	7	8	9	10	11	12
<b>6760-4</b>	763	789	810	841	884	905	944	1007	1055	1109	1220	1338

  

OVERALL DIMENSIONS			SEAT DIMENSIONS			BACK DIMENSIONS	
W	D	H	W	D	H	W	H
26	24	45	19.5	19	16-20	17.5	27

RTA 2

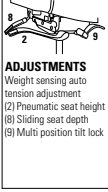

DESCRIPTION	FEATURES	MODEL#	STANDARD TEXTILE GRADES													
			1	2	3	4	5	6	7	8	9	10	11	12		
 <p><b>Weight Sensing Sychro-Tilter w/Adjustable Headrest</b> COM Yardage: 1 Freight Class: 150 Product Weight (lbs.): 55 Cubic Feet Per Carton: 11</p>	 <p><b>ADJUSTMENTS</b> Weight sensing auto tension adjustment (2) Pneumatic seat height (8) Sliding seat depth (9) Multi position tilt lock</p>	<b>6760-8</b>	866	892	913	944	987	1008	1047	1110	1159	1213	1324	1441		
		<b>OVERALL DIMENSIONS</b>			<b>SEAT DIMENSIONS</b>			<b>BACK DIMENSIONS</b>								
		<b>W</b>	<b>D</b>	<b>H</b>	<b>W</b>	<b>D</b>	<b>H</b>	<b>W</b>	<b>H</b>							
	26	24	45	19.5	19-21.5	16-20	17.5	27								
			<b>RTA 2</b>													

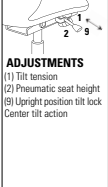
DESCRIPTION	FEATURES	MODEL#	STANDARD TEXTILE GRADES													
			1	2	3	4	5	6	7	8	9	10	11	12		
 <p><b>Tilter</b> COM Yardage: 1 Freight Class: 150 Product Weight (lbs.): 48 Cubic Feet Per Carton: 10.50</p>	 <p><b>ADJUSTMENTS</b> (1) Tilt tension (2) Pneumatic seat height (9) Upright position tilt lock Center tilt action</p>	<b>6761-4</b>	716	742	763	794	837	857	897	958	1007	1060	1172	1289		
		<b>OVERALL DIMENSIONS</b>			<b>SEAT DIMENSIONS</b>			<b>BACK DIMENSIONS</b>								
		<b>W</b>	<b>D</b>	<b>H</b>	<b>W</b>	<b>D</b>	<b>H</b>	<b>W</b>	<b>H</b>							
	26	24	38.5	19.5	19	16-20	17.5	20								
			<b>RTA 2</b>													

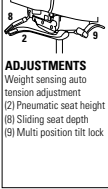
DESCRIPTION	FEATURES	MODEL#	STANDARD TEXTILE GRADES													
			1	2	3	4	5	6	7	8	9	10	11	12		
 <p><b>Weight Sensing Sychro-Tilter</b> COM Yardage: 1 Freight Class: 150 Product Weight (lbs.): 54 Cubic Feet Per Carton: 10.50</p>	 <p><b>ADJUSTMENTS</b> Weight sensing auto tension adjustment (2) Pneumatic seat height (8) Sliding seat depth (9) Multi position tilt lock</p>	<b>6761-8</b>	819	845	866	897	940	960	1000	1062	1111	1164	1276	1393		
		<b>OVERALL DIMENSIONS</b>			<b>SEAT DIMENSIONS</b>			<b>BACK DIMENSIONS</b>								
		<b>W</b>	<b>D</b>	<b>H</b>	<b>W</b>	<b>D</b>	<b>H</b>	<b>W</b>	<b>H</b>							
	26	24	38.5	19.5	19-21.5	16-20	17.5	20								
			<b>RTA 2</b>													

SUPRA™



model 5330-4 (UB)



model 5332 (TUN)



**Impact Resistant Back**  
All models are standard with an impact resistant back cover, in Black Only.



model 5332



**Optional Base**  
Arched aluminum base available as an option on models that are standard with a black arched base. Specify "B5". Add \$121.

STANDARD FEATURES

- Contoured cushions support the user in a comfortable, contemporary style.
- Stylish arm/frame design sweeps from under the seat through the back and culminates in a hoop at the rear of the seat.
- Tilters are standard with a Tungsten (TUN) finish and Black base. Armchairs are standard with a Tungsten finish (TUN).
- Molded self-skinned urethane waterfall armrests are available in Black (BK) Only.
- The impact resistant outer back shell adds a decorative look and protects from damage. Available in Black (BK) Only.
- All models (except armchairs) are standard with a five-legged, injection molded "spider" base with C65 casters are standard.
- Model 5331-4SC features a self centering cylinder which swivels and automatically returns to the starting seat location. This model is standard with a flat 5 star base in Black (BK) with C7 glides.

OPTIONAL FEATURES

- Models 5332 and 5332L can be joined together using ganging clamp model 5233.
- Optional steel cushioned glides (B) are available on models 5332 and 5332L. Add \$23. Please specify
- Please note that partially KD models 5330-4 and 5331-5 are part of the 2 Day Lightning quick ship program. Please contact a Global Sales Representative.
- Not available in Leather/Mock Leather combination (Grade 5).
- Optional frame finishes include: Please Specify a Tungsten finish with Tungsten base (UT)\* on Tilter models. Add \$65. (\* Equipped with a 3" cylinder instead of the standard 4" cylinder to maintain seat height range.) For a Chrome (CH) finish on armchairs. Add \$91.
- Please refer to the "Casters Selection" section of the price book for caster options. Optional casters may be priced higher than the standard casters for your chair and the difference will be charged. Lower priced optional casters will not be credited.
- For hard surface flooring casters, please specify C65R casters. Add \$51.
- For fully assembled in box, please specify SU. Add \$55.

DESCRIPTION FEATURES MODEL# STANDARD TEXTILE GRADES



5330-2



5330L-2

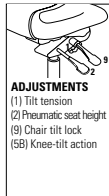

**ADJUSTMENTS**  
(1) Tilt tension  
(2) Pneumatic seat height  
(9) Chair tilt lock  
(5B) Knee-tilt action

**HB Knee - Tilter**  
COM Yardage: 1.50  
Freight Class: 250  
Product Weight (lbs.): 41  
Cubic Feet Per Carton: 13.25

Ergonomic Features:  
A, B, C, J, M, N

MODEL#	1	2	3	4	5	6	7	8	9	10	11	12
5330-2	702	742	774	822	887	912	972	1083	1138	1241	1381	1558

OVERALL DIMENSIONS			SEAT DIMENSIONS			BACK DIMENSIONS	
W	D	H	W	D	H	W	H
26	27	42.5	21	18.5	17.5-21.5	20	24

RTA 2



5330-4



5330L-4

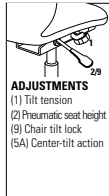

**ADJUSTMENTS**  
(1) Tilt tension  
(2) Pneumatic seat height  
(9) Chair tilt lock  
(5A) Center-tilt action

**HB Tilter**  
COM Yardage: 1.50  
Freight Class: 250  
Product Weight (lbs.): 38  
Cubic Feet Per Carton: 12

Ergonomic Features:  
A, B, C, M, N, S

MODEL#	1	2	3	4	5	6	7	8	9	10	11	12
5330-4	533	572	604	651	717	742	801	914	969	1072	1212	1389

OVERALL DIMENSIONS			SEAT DIMENSIONS			BACK DIMENSIONS	
W	D	H	W	D	H	W	H
26	27	42	21	18.5	16.5-20.5	20	24

RTA 2



5331-2



5331L-2

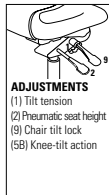

**ADJUSTMENTS**  
(1) Tilt tension  
(2) Pneumatic seat height  
(9) Chair tilt lock  
(5B) Knee-tilt action

**MB Knee - Tilter**  
COM Yardage: 1.25  
Freight Class: 250  
Product Weight (lbs.): 39  
Cubic Feet Per Carton: 13.25













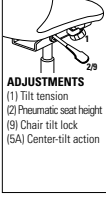

Ergonomic Features:  
A, B, C, J, M, N

MODEL#	1	2	3	4	5	6	7	8	9	10	11	12
5331-2	665	699	726	764	821	841	890	981	1027	1114	1231	1379

OVERALL DIMENSIONS			SEAT DIMENSIONS			BACK DIMENSIONS	
W	D	H	W	D	H	W	H
26	26	39.5	21	18.5	17.5-21.5	20	19.5

RTA 2



DESCRIPTION		FEATURES	MODEL#	STANDARD TEXTILE GRADES											
 <p><b>5331-4</b></p>	 <p><b>5331L-4</b></p>	 <p><b>ADJUSTMENTS</b>                      (1) Tilt tension                      (2) Pneumatic seat height                      (3) Chair tilt lock                      (5A) Center-tilt action</p>		1	2	3	4	5	6	7	8	9	10	11	12
			<b>5331-4</b>	498	531	560	596	652	675	723	816	861	946	1064	1212
<p><b>MB Tilter</b>                      COM Yardage: 1.25                      Freight Class: 250                      Product Weight (lbs.): 35                      Cubic Feet Per Carton: 12</p>				<p>Ergonomic Features:                      A, B, C, M, N, S</p>				<p><b>RTA 2</b></p>							
 <p><b>5331-4SC</b></p>	 <p><b>5331L-4SC</b></p>		1	2	3	4	5	6	7	8	9	10	11	12	
		<b>5331-4SC</b>	553	589	614	654	713	732	781	877	923	1012	1131	1281	
<p><b>MB Conference Chair</b>                      COM Yardage: 1.25                      Freight Class: 250                      Product Weight (lbs.): 37                      Cubic Feet Per Carton: 11.50</p>				<p>Ergonomic Features:                      A, B, C, M, N, S</p>				<p><b>RTA 2</b></p>							
 <p><b>5332</b></p>	 <p><b>5332L</b></p>		1	2	3	4	5	6	7	8	9	10	11	12	
		<b>5332</b>	415	448	473	514	570	591	640	732	776	863	980	1127	
<p><b>Armchair</b>                      COM Yardage: 1.25                      Freight Class: 300                      Product Weight (lbs.): 28                      Cubic Feet Per Carton: 17</p>				<p>Ergonomic Features:                      M, N</p>				<p><b>RTA 00</b></p>							
 <p><b>5332C</b></p>	 <p><b>5332LC</b></p>		1	2	3	4	5	6	7	8	9	10	11	12	
		<b>5332C</b>	546	580	608	648	705	726	776	871	917	1005	1124	1276	
<p><b>Armchair Casters</b>                      COM Yardage: 1.25                      Freight Class: 300                      Product Weight (lbs.): 28                      Cubic Feet Per Carton: 17</p>				<p>Ergonomic Features:                      M, N</p>				<p><b>RTA 00</b></p>							
 <p><b>5335</b></p>	 <p><b>5335L</b></p>		1	2	3	4	5	6	7	8	9	10	11	12	
		<b>5335</b>	498	531	560	596	652	675	723	816	861	946	1064	1212	
<p><b>Armchair Sled base</b>                      COM Yardage: 1.25                      Freight Class: 300                      Product Weight (lbs.): 33                      Cubic Feet Per Carton: 17.50</p>				<p>Ergonomic Features:                      M, N</p>				<p><b>RTA 00</b></p>							



SUPRA X™



model 5336-3 (UG)



model 5336-5



**Impact Resistant Back**  
All models are standard with an impact resistant back cover, in Black Only.



**Optional Base**  
An optional five-legged, arched metal base in Tungsten finish is available. (No Cover Can Used) Specify (UG). Add \$63



model 5337-6

STANDARD FEATURES

- Ergonomic office seating with height adjustable lumbar support.
- Control knobs on the outside of the back allow the adjustment of the lumbar support.
- An impact resistant outer back shell adds a distinctive look to this series and protects against damage.
- Height and depth adjustable lumbar support.
- Standard with adjustable height forward swept arms with kidney shaped urethane armcaps (SC).
- Base and frame are standard in Black (BK).
- All models are standard with a five-legged, injection molded "spider" base.
- C65 casters are standard.

OPTIONAL FEATURES

- Please refer to "Arms Selection" section of the price book for arm options.
- Please refer to "Cylinder Selection" section of the price book for additional cylinder options.
- Please refer to the "Casters Selection" section of the price book for caster options. Optional casters may be priced higher than the standard casters for your chair and the difference will be charged. Lower priced optional casters will not be credited.
- For hard surface flooring casters, please specify C65R casters. Add \$51
- For availability of chair series in Vinyl, please contact a Global Sales Representative. Not available in Leather/Mock Leather combination (Grade 5).
- Vari-Width Adapter Plate (WA) is standard when chair is ordered with adjustable height arms. Allows each arm to move outward an additional 2" (for a total of 4" extra seat width) and locks with the use of an easy to maneuver lever (WA).
- For fully assembled in box, please specify SU. Add \$55.

DESCRIPTION FEATURES MODEL# STANDARD TEXTILE GRADES



5333-3



5333L-3

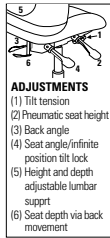

**ADJUSTMENTS**  
(1) Tilt tension  
(2) Pneumatic seat height  
(3) Back angle  
(4) Seat angle/infinite position tilt lock  
(5) Height and depth adjustable lumbar support  
(6) Seat depth via back movement

**HB Multi - Tilter**  
COM Yardage: 1.50  
Freight Class: 150  
Product Weight (lbs.): 50  
Cubic Feet Per Carton: 9.75

Ergonomic Features:  
A, B, C, E, G, H, M, N, S

	1	2	3	4	5	6	7	8	9	10	11	12
<b>5333-3</b>	799	840	872	920	989	1013	1073	1188	1242	1349	1492	1671

OVERALL DIMENSIONS			SEAT DIMENSIONS			BACK DIMENSIONS	
W	D	H	W	D	H	W	H
26	26.5	41	20	19-20	16-20	18	23.5

RTA 2



5333-4



5333L-4

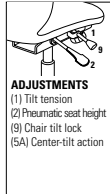

**ADJUSTMENTS**  
(1) Tilt tension  
(2) Pneumatic seat height  
(9) Chair tilt lock  
(5A) Center-tilt action

**HB Tilter**  
COM Yardage: 1.50  
Freight Class: 150  
Product Weight (lbs.): 47  
Cubic Feet Per Carton: 9.75

Ergonomic Features:  
A, B, C, E, H, M, N, S

	1	2	3	4	5	6	7	8	9	10	11	12
<b>5333-4</b>	744	785	818	867	935	957	1019	1133	1188	1292	1437	1618

OVERALL DIMENSIONS			SEAT DIMENSIONS			BACK DIMENSIONS	
W	D	H	W	D	H	W	H
26	25.5	41.5	21	18-19	16-20	18	23

RTA 2



5336-1



5336L-1

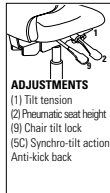

**ADJUSTMENTS**  
(1) Tilt tension  
(2) Pneumatic seat height  
(9) Chair tilt lock  
(5C) Synchro-tilt action  
Anti-kick back

**MB Synchro - Tilter**  
COM Yardage: 1.25  
Freight Class: 150  
Product Weight (lbs.): 49  
Cubic Feet Per Carton: 9.75













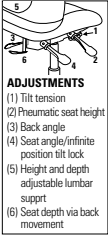



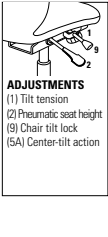

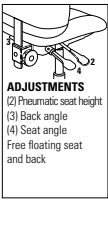

Ergonomic Features:  
A, B, C, H, L, M, N, Q



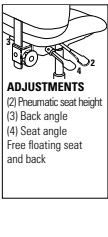



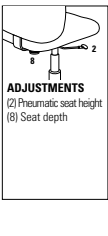

	1	2	3	4	5	6	7	8	9	10	11	12
<b>5336-1</b>	933	970	995	1036	1092	1113	1163	1258	1303	1393	1509	1661

OVERALL DIMENSIONS			SEAT DIMENSIONS			BACK DIMENSIONS	
W	D	H	W	D	H	W	H
26	26.5	37.5	20	19-20	16-20	18	16.5

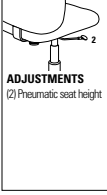
RTA 2

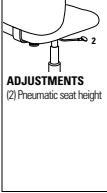

DESCRIPTION	FEATURES	MODEL#	STANDARD TEXTILE GRADES												
 <b>5336-3</b> <b>MB Multi - Tilter</b> COM Yardage: 1.25 Freight Class: 150 Product Weight (lbs.): 47 Cubic Feet Per Carton: 8.25	 <b>5336L-3</b> Ergonomic Features: A, B, C, E, G, H, M, N, Q, S	 <p><b>ADJUSTMENTS</b></p> (1) Tilt tension (2) Pneumatic seat height (3) Back angle (4) Seat angle/infinite position tilt lock (5) Height and depth adjustable lumbar support (6) Seat depth via back movement	1	2	3	4	5	6	7	8	9	10	11	12	
			<b>5336-3</b>	679	706	727	759	803	821	860	935	970	1038	1133	1251
			<b>OVERALL DIMENSIONS</b> W D H 26 26.5 37.5 <b>SEAT DIMENSIONS</b> W D H 20 17-18.5 17-21 <b>BACK DIMENSIONS</b> W H 18 20	<b>RTA 2</b>											
 <b>5336-4</b> <b>HB Tilter</b> COM Yardage: 1.25 Freight Class: 150 Product Weight (lbs.): 45 Cubic Feet Per Carton: 8.25	 <b>5336L-4</b> Ergonomic Features: A, B, C, E, H, M, N, Q, S	 <p><b>ADJUSTMENTS</b></p> (1) Tilt tension (2) Pneumatic seat height (9) Chair tilt lock (5A) Center-tilt action	1	2	3	4	5	6	7	8	9	10	11	12	
			<b>5336-4</b>	679	706	727	759	803	821	860	935	970	1038	1133	1251
			<b>OVERALL DIMENSIONS</b> W D H 26 25.5 37.5 <b>SEAT DIMENSIONS</b> W D H 21 18-19 16-20 <b>BACK DIMENSIONS</b> W H 19 19	<b>RTA 2</b>											
 <b>5336-5</b> <b>MB Operator</b> COM Yardage: 1.25 Freight Class: 150 Product Weight (lbs.): 44 Cubic Feet Per Carton: 7.50	 <b>5336L-5</b> Ergonomic Features: C, E, F, G, H, M, N, Q, S	 <p><b>ADJUSTMENTS</b></p> (2) Pneumatic seat height (3) Back angle (4) Seat angle Free floating seat and back	1	2	3	4	5	6	7	8	9	10	11	12	
			<b>5336-5</b>	656	684	705	738	780	799	836	912	949	1018	1112	1229
			<b>OVERALL DIMENSIONS</b> W D H 26 27.5 37.5 <b>SEAT DIMENSIONS</b> W D H 20 17-18.5 16.5-21.5 <b>BACK DIMENSIONS</b> W H 18 20	<b>RTA 2</b>											
 <b>5337-5</b> <b>MB Operator Armless</b> COM Yardage: 1.25 Freight Class: 150 Product Weight (lbs.): 38 Cubic Feet Per Carton: 7	 <b>5337L-5</b> Ergonomic Features: C, E, F, G, M, N, Q, S	 <p><b>ADJUSTMENTS</b></p> (2) Pneumatic seat height (3) Back angle (4) Seat angle Free floating seat and back	1	2	3	4	5	6	7	8	9	10	11	12	
			<b>5337-5</b>	543	571	592	623	668	684	724	799	832	904	998	1115
			<b>OVERALL DIMENSIONS</b> W D H 20 27.5 37.5 <b>SEAT DIMENSIONS</b> W D H 20 17-18.5 16.5-21.5 <b>BACK DIMENSIONS</b> W H 18 20	<b>RTA 2</b>											
 <b>5337-6</b> <b>MB Task Armless</b> COM Yardage: 1.25 Freight Class: 150 Product Weight (lbs.): 30 Cubic Feet Per Carton: 7	 <b>5337L-6</b> Ergonomic Features: C, E, M, N, Q	 <p><b>ADJUSTMENTS</b></p> (2) Pneumatic seat height (8) Seat depth	1	2	3	4	5	6	7	8	9	10	11	12	
			<b>5337-6</b>	440	467	487	518	563	578	618	694	730	799	894	1011
			<b>OVERALL DIMENSIONS</b> W D H 20 25 38.5 <b>SEAT DIMENSIONS</b> W D H 20 17-18.5 16.5-21.5 <b>BACK DIMENSIONS</b> W H 18 20	<b>RTA 2</b>											

DESCRIPTION	FEATURES	MODEL#	STANDARD TEXTILE GRADES														
			1	2	3	4	5	6	7	8	9	10	11	12			
 <p><b>5338-6</b></p> <p><b>Drafting Chair Task</b>                      COM Yardage: 1.25                      Freight Class: 150                      Product Weight (lbs.): 40                      Cubic Feet Per Carton: 7.50</p>	 <p><b>5338L-6</b></p>	 <p><b>ADJUSTMENTS</b> (2) Pneumatic seat height</p>	<b>5338-6</b>	907	936	955	988	1030	1049	1088	1163	1198	1266	1362	1480		
			<b>OVERALL DIMENSIONS</b>			<b>SEAT DIMENSIONS</b>			<b>BACK DIMENSIONS</b>								
			<b>W</b>	<b>D</b>	<b>H</b>	<b>W</b>	<b>D</b>	<b>H</b>	<b>W</b>	<b>H</b>							
			26	25	46.5	20	18.5-19.5	23.5-33.5	18	19							
			<b>RTA 2</b>														
 <p><b>5339-6</b></p> <p><b>Drafting Chair Task Armless</b>                      COM Yardage: 1.25                      Freight Class: 150                      Product Weight (lbs.): 34                      Cubic Feet Per Carton: 7.50</p>	 <p><b>5339L-6</b></p>	 <p><b>ADJUSTMENTS</b> (2) Pneumatic seat height</p>	<b>5339-6</b>	791	818	836	870	914	931	971	1046	1080	1150	1245	1362		
			<b>OVERALL DIMENSIONS</b>			<b>SEAT DIMENSIONS</b>			<b>BACK DIMENSIONS</b>								
			<b>W</b>	<b>D</b>	<b>H</b>	<b>W</b>	<b>D</b>	<b>H</b>	<b>W</b>	<b>H</b>							
			20	25	46.5	20	18.5-19.5	23.5-33.5	18	19							
			<b>RTA 2</b>														

SYNOPSIS®



model 5080-3



model 5091-4

STANDARD FEATURES

- A compound curved back adds a distinct look while maximizing comfort.
- Fixed height, impact and scuff resistant curved arms are standard on models 5090-4, 5091-4 and 5092
- Tilter, Synchro-Tilter, and Multi-Tilter models (starting with 5080) are standard with adjustable height T arms with teardrop shaped urethane armcaps (3B).
- Ratchet style back height and pneumatic seat height adjustments is standard on Synchro-Tilter and Multi-Tilter models.
- Vari-Width (WA), Width adjustable arm extensions are standard with adjustable height T arms.
- Synchro-Tilter and Multi-Tilters feature a black impact resistant outer back shell. Drafting stools have a plastic back panel. All other models feature a fully upholstered outer back.
- Sliding seat depth is available on Synchro-Tilters and Multi-Tilters. Seat depth can be adjusted with a lever on the side of the chair.
- All models (except armchair) are standard with a five-legged, injection molded base.
- Base and arms are available in Black (BK) Only.
- C65 casters are standard.

OPTIONAL FEATURES

- Available with Memory Foam (MF). Add \$84.
- Polished Aluminum base with black scuff tips. Specify "B2". Add \$121. Available on select models: 5080-0, 5080-4, 5081-0, 5081-4, 5090-4, and 5091-4.
- Please refer to "Arms Selection" section of the price book for arm options.
- Please refer to "Cylinder Selection" section of the price book for additional cylinder options.
- For hard surface flooring casters please specify C65R, add \$51.
- Please refer to the "Casters Selection" section of the price book for caster options. Optional casters may be priced higher than the standard casters for your chair and the difference will be charged. Lower priced optional casters will not be credited.
- Available in fabric, vinyl or leather/mock leather with the EXCEPTION of Match, Imprint, and Renewal.
- For fully assembled in box, please specify SU. Add \$55.

DESCRIPTION FEATURES MODEL# STANDARD TEXTILE GRADES



**HB Synchro - Tilter w/Back Angle Adjustment**  
COM Yardage: 2  
Freight Class: 150  
Product Weight (lbs.): 65  
Cubic Feet Per Carton: 14.25

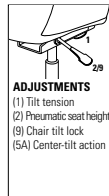

Ergonomic Features:  
A, B, C, E, H, L, M, N, R

MODEL#	1	2	3	4	5	6	7	8	9	10	11	12
5080-0	884	980	1022	1083	1171	1201	1278	1423	1491	1627	1809	2037

OVERALL DIMENSIONS			SEAT DIMENSIONS			BACK DIMENSIONS	
W	D	H	W	D	H	W	H
24	25	46	19.5	18-20.5	17-21	19	26-28.5

RTA 1



**HB Multi - Tilter**  
COM Yardage: 2  
Freight Class: 150  
Product Weight (lbs.): 67  
Cubic Feet Per Carton: 14.25

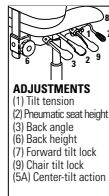

Ergonomic Features:  
A, B, C, D, E, F, G, H, M, N, Q, S

MODEL#	1	2	3	4	5	6	7	8	9	10	11	12
5080-3	884	980	1022	1083	1171	1201	1278	1423	1491	1627	1809	2037

OVERALL DIMENSIONS			SEAT DIMENSIONS			BACK DIMENSIONS	
W	D	H	W	D	H	W	H
24	25	46	19.5	18-20.5	17-21	19	26-28.5

RTA 1



**HB Tilter**  
COM Yardage: 2  
Freight Class: 150  
Product Weight (lbs.): 45  
Cubic Feet Per Carton: 9.75

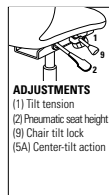





Ergonomic Features:  
A, B, C, M, N, S

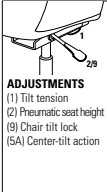

MODEL#	1	2	3	4	5	6	7	8	9	10	11	12
5080-4	758	809	850	912	998	1029	1105	1250	1320	1454	1637	1866

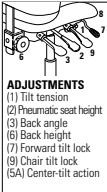

OVERALL DIMENSIONS			SEAT DIMENSIONS			BACK DIMENSIONS	
W	D	H	W	D	H	W	H
24.5	26.5	43.5	19.5	18-19.5	16.5-20.5	19	25.5

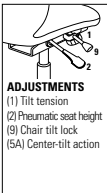

RTA 2

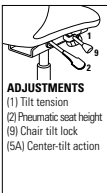

DESCRIPTION	FEATURES	MODEL#	STANDARD TEXTILE GRADES											
			1	2	3	4	5	6	7	8	9	10	11	12
 <p><b>MB Synchro - Tilter w/Back Angle Adjustment</b> COM Yardage: 1.75 Freight Class: 150 Product Weight (lbs.): 62 Cubic Feet Per Carton: 14.25</p>	 <p><b>ADJUSTMENTS</b> (1) Tilt tension (2) Pneumatic seat height (9) Chair tilt lock (5A) Center-tilt action</p>	<b>5081-0</b>	800	885	922	975	1051	1079	1145	1272	1333	1451	1611	1810
			<b>OVERALL DIMENSIONS</b>			<b>SEAT DIMENSIONS</b>			<b>BACK DIMENSIONS</b>					
			<b>W</b>	<b>D</b>	<b>H</b>	<b>W</b>	<b>D</b>	<b>H</b>	<b>W</b>	<b>H</b>				
	24	25	42	19.5	18-20.5	17-21	19	22-24.5						
				<b>RTA 1</b>										

 <p><b>MB Multi - Tilter</b> COM Yardage: 1.75 Freight Class: 150 Product Weight (lbs.): 64 Cubic Feet Per Carton: 14.25</p>	 <p><b>ADJUSTMENTS</b> (1) Tilt tension (2) Pneumatic seat height (3) Back angle (6) Back height (7) Forward tilt lock (9) Chair tilt lock (5A) Center-tilt action</p>	<b>5081-3</b>	800	885	922	975	1051	1079	1145	1272	1333	1451	1611	1810
			<b>OVERALL DIMENSIONS</b>			<b>SEAT DIMENSIONS</b>			<b>BACK DIMENSIONS</b>					
			<b>W</b>	<b>D</b>	<b>H</b>	<b>W</b>	<b>D</b>	<b>H</b>	<b>W</b>	<b>H</b>				
	24	25	42	19.5	18-20.5	17-21	19	22-24.5						
				<b>RTA 1</b>										

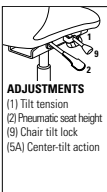
 <p><b>MB Tilter</b> COM Yardage: 1.75 Freight Class: 150 Product Weight (lbs.): 45 Cubic Feet Per Carton: 9.75</p>	 <p><b>ADJUSTMENTS</b> (1) Tilt tension (2) Pneumatic seat height (9) Chair tilt lock (5A) Center-tilt action</p>	<b>5081-4</b>	665	714	753	811	895	933	1008	1126	1219	1321	1532	1757
			<b>OVERALL DIMENSIONS</b>			<b>SEAT DIMENSIONS</b>			<b>BACK DIMENSIONS</b>					
			<b>W</b>	<b>D</b>	<b>H</b>	<b>W</b>	<b>D</b>	<b>H</b>	<b>W</b>	<b>H</b>				
	24.5	26.5	43.5	19.5	18-19.5	16.5-20.5	19	25.5						
				<b>RTA 2</b>										

 <p><b>HB Tilter</b> COM Yardage: 2 Freight Class: 250 Product Weight (lbs.): 41 Cubic Feet Per Carton: 11.50</p>	 <p><b>ADJUSTMENTS</b> (1) Tilt tension (2) Pneumatic seat height (9) Chair tilt lock (5A) Center-tilt action</p>	<b>5090-4</b>	552	631	671	733	821	851	926	1072	1141	1278	1459	1688
			<b>OVERALL DIMENSIONS</b>			<b>SEAT DIMENSIONS</b>			<b>BACK DIMENSIONS</b>					
			<b>W</b>	<b>D</b>	<b>H</b>	<b>W</b>	<b>D</b>	<b>H</b>	<b>W</b>	<b>H</b>				
	24.5	26.5	43.5	19.5	19.5	16.5-20.5	19	25.5						
				<b>RTA 1</b>										

 <p><b>MB Tilter</b> COM Yardage: 1.75 Freight Class: 250 Product Weight (lbs.): 38 Cubic Feet Per Carton: 11.50</p>	 <p><b>ADJUSTMENTS</b> (1) Tilt tension (2) Pneumatic seat height (9) Chair tilt lock (5A) Center-tilt action</p>	<b>5091-4</b>	518	590	625	678	754	781	848	975	1036	1154	1314	1514
			<b>OVERALL DIMENSIONS</b>			<b>SEAT DIMENSIONS</b>			<b>BACK DIMENSIONS</b>					
			<b>W</b>	<b>D</b>	<b>H</b>	<b>W</b>	<b>D</b>	<b>H</b>	<b>W</b>	<b>H</b>				
	24.5	26.5	39.5	19.5	19.5	16.5-20.5	19	21.5						
				<b>RTA 1</b>										

DESCRIPTION	FEATURES	MODEL#	STANDARD TEXTILE GRADES													
			1	2	3	4	5	6	7	8	9	10	11	12		
 <p><b>Armchair</b>                      COM Yardage: 1.75                      Freight Class: 250                      Product Weight (lbs.): 40                      Cubic Feet Per Carton: 17</p>	<p>Ergonomic Features:                      M, N</p>	<p><b>5092</b></p>	525	597	633	685	763	791	855	982	1045	1161	1323	1521		
			OVERALL DIMENSIONS			SEAT DIMENSIONS			BACK DIMENSIONS							
			W	D	H	W	D	H	W	H						
			25	26	37	19.5	19	16.5	19	27						
																

TAMIRI®



model 4520-3 (TD)



model 4522

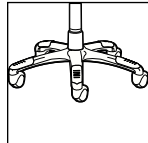

**Optional Base**

Polished aluminum base with black scuff tips (B2) is available at an upcharge. Add \$121.









model 4526



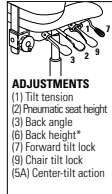

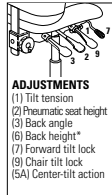



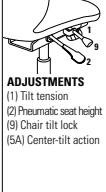

**STANDARD FEATURES**

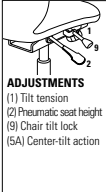
- Perforated, breathable leather panels in the seat and back provide long-term comfort through better ventilation.
- Fixed height, impact and scuff resistant curved arms with perforated leather pads are standard on managerial, executive and armchair models.
- All other models are standard with adjustable height T-arms with teardrop shaped urethane armcaps (TD).
- Models 4522, 4526 and 4527 are standard with upholstered armcaps. All polypropylene arms are available at no charge. Please specify "PA" when ordering.
- All models (except armchair) are standard with a five-legged, injection molded "spider" base.
- Base and arms are available in Black (BK) Only.
- C10 casters are standard.
- Standard in Leather/Mock Leather combination (Grade 5).
- Not available in Fabric.
- Vari-Width (WA) Width Adjustable Arm Extensions are standard.

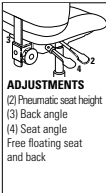

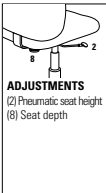
**OPTIONAL FEATURES**

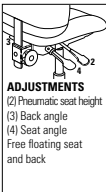
- Available with back edge vinyl bumper guard option (VBG). Add \$18.
- Polished Aluminum base with black scuff tips. Specify "B2". Add \$121.
- Please refer to "Arms Selection" section of the price book for arm options.
- For hard surface flooring casters Please Specify C10R, Add \$46.
- Please refer to the "Casters Selection" section of the price book for caster options. Optional casters may be priced higher than the standard casters for your chair and the difference will be charged. Lower priced optional casters will not be credited.
- For fully assembled in box, please specify SU. Add \$55.

DESCRIPTION	FEATURES	MODEL#	STANDARD FABRIC GRADES												
			1	2	3	4	5	6	7	8	9	10	11	12	
 <p><b>HB Multi - Tilter</b> w/Adj. Teardrop Arms COM Yardage: 2.25 Freight Class: 150 Product Weight (lbs.): 61 Cubic Feet Per Carton: 11</p>	 <p><b>ADJUSTMENTS</b> (1) Tilt tension (2) Pneumatic seat height (3) Back angle (6) Back height* (7) Forward tilt lock (8) Chair tilt lock (5A) Center-tilt action</p>	<p>Ergonomic Features: A, B, C, D, F, G, H, M, N, Q, S</p>	4520-3	-	-	-	-	938	-	-	1229	1319	1467	1688	1952
			<b>OVERALL DIMENSIONS</b>			<b>SEAT DIMENSIONS</b>			<b>BACK DIMENSIONS</b>						
			<b>W</b>	<b>D</b>	<b>H</b>	<b>W</b>	<b>D</b>	<b>H</b>	<b>W</b>		<b>H</b>				
			25.5	26.5	47.5	22	19.5	17-21	21		26-28				
			RTA 2												
 <p><b>MB Multi - Tilter</b> w/Adj. Teardrop Arms COM Yardage: 2 Freight Class: 150 Product Weight (lbs.): 53 Cubic Feet Per Carton: 9.50</p>	 <p><b>ADJUSTMENTS</b> (1) Tilt tension (2) Pneumatic seat height (3) Back angle (6) Back height* (7) Forward tilt lock (8) Chair tilt lock (5A) Center-tilt action</p>	<p>Ergonomic Features: A, B, C, D, F, G, H, M, N, Q, S</p>	4521-3	-	-	-	-	849	-	-	1109	1190	1319	1518	1750
			<b>OVERALL DIMENSIONS</b>			<b>SEAT DIMENSIONS</b>			<b>BACK DIMENSIONS</b>						
			<b>W</b>	<b>D</b>	<b>H</b>	<b>W</b>	<b>D</b>	<b>H</b>	<b>W</b>		<b>H</b>				
			25	26	41	22	19	17-21	21		20.5-22.5				
			RTA 2												
 <p><b>Armchair</b> w/Fixed Loop Arms COM Yardage: 2 Freight Class: 150 Product Weight (lbs.): 41 Cubic Feet Per Carton: 10</p>	<p>Ergonomic Features: M, N</p>	<p>Ergonomic Features: M, N</p>	4522	-	-	-	-	556	-	-	816	897	1026	1224	1458
			<b>OVERALL DIMENSIONS</b>			<b>SEAT DIMENSIONS</b>			<b>BACK DIMENSIONS</b>						
			<b>W</b>	<b>D</b>	<b>H</b>	<b>W</b>	<b>D</b>	<b>H</b>	<b>W</b>		<b>H</b>				
			25	26.5	37	22	19.5	17.5	21		19				
			RTA 2												

DESCRIPTION	FEATURES	MODEL#	STANDARD FABRIC GRADES																														
			1	2	3	4	5	6	7	8	9	10	11	12																			
 <p><b>HB Tilter</b> w/Fixed Loop Arms COM Yardage: 2.25 Freight Class: 250 Product Weight (lbs.): 45 Cubic Feet Per Carton: 11.50</p>	 <p><b>ADJUSTMENTS</b> (1) Tilt tension (2) Pneumatic seat height (9) Chair tilt lock (5A) Center-tilt action</p>	<p><b>Ergonomic Features:</b> A, B, C, M, N, S</p>	<table border="1"> <tr> <td>4526</td> <td>-</td> <td>-</td> <td>-</td> <td>-</td> <td>708</td> <td>-</td> <td>-</td> <td>1000</td> <td>1090</td> <td>1236</td> <td>1459</td> <td>1722</td> </tr> </table>												4526	-	-	-	-	708	-	-	1000	1090	1236	1459	1722						
			4526	-	-	-	-	708	-	-	1000	1090	1236	1459	1722																		
			<table border="1"> <tr> <th colspan="3">OVERALL DIMENSIONS</th> <th colspan="3">SEAT DIMENSIONS</th> <th colspan="3">BACK DIMENSIONS</th> </tr> <tr> <th>W</th> <th>D</th> <th>H</th> <th>W</th> <th>D</th> <th>H</th> <th>W</th> <th>H</th> </tr> <tr> <td>25</td> <td>27</td> <td>45</td> <td>22</td> <td>19.5</td> <td>17-22</td> <td>21</td> <td>25</td> </tr> </table>			OVERALL DIMENSIONS			SEAT DIMENSIONS			BACK DIMENSIONS			W	D	H	W	D	H	W	H	25	27	45	22	19.5	17-22	21	25	<p><b>RTA 1</b> </p>		
			OVERALL DIMENSIONS			SEAT DIMENSIONS			BACK DIMENSIONS																								
W	D	H	W	D	H	W	H																										
25	27	45	22	19.5	17-22	21	25																										
 <p><b>LB Tilter</b> w/Fixed Loop Arms COM Yardage: 2 Freight Class: 150 Product Weight (lbs.): 42 Cubic Feet Per Carton: 9.75</p>	 <p><b>ADJUSTMENTS</b> (1) Tilt tension (2) Pneumatic seat height (9) Chair tilt lock (5A) Center-tilt action</p>	<p><b>Ergonomic Features:</b> A, B, C, M, N, S</p>	<table border="1"> <tr> <td>4527</td> <td>-</td> <td>-</td> <td>-</td> <td>-</td> <td>618</td> <td>-</td> <td>-</td> <td>879</td> <td>959</td> <td>1089</td> <td>1287</td> <td>1521</td> </tr> </table>												4527	-	-	-	-	618	-	-	879	959	1089	1287	1521						
			4527	-	-	-	-	618	-	-	879	959	1089	1287	1521																		
			<table border="1"> <tr> <th colspan="3">OVERALL DIMENSIONS</th> <th colspan="3">SEAT DIMENSIONS</th> <th colspan="3">BACK DIMENSIONS</th> </tr> <tr> <th>W</th> <th>D</th> <th>H</th> <th>W</th> <th>D</th> <th>H</th> <th>W</th> <th>H</th> </tr> <tr> <td>25</td> <td>26.5</td> <td>39</td> <td>22</td> <td>19.5</td> <td>17-22</td> <td>21</td> <td>19</td> </tr> </table>			OVERALL DIMENSIONS			SEAT DIMENSIONS			BACK DIMENSIONS			W	D	H	W	D	H	W	H	25	26.5	39	22	19.5	17-22	21	19	<p><b>RTA 1</b> </p>		
			OVERALL DIMENSIONS			SEAT DIMENSIONS			BACK DIMENSIONS																								
W	D	H	W	D	H	W	H																										
25	26.5	39	22	19.5	17-22	21	19																										
 <p><b>LB Operator</b> w/Adj. Teardrop Arms COM Yardage: 1.75 Freight Class: 150 Product Weight (lbs.): 44 Cubic Feet Per Carton: 7.50</p>	 <p><b>ADJUSTMENTS</b> (2) Pneumatic seat height (3) Back angle (4) Seat angle Free floating seat and back.</p>	<p><b>Ergonomic Features:</b> C, D, F, G, H, M, N, Q</p>	<table border="1"> <tr> <td>4528-5</td> <td>-</td> <td>-</td> <td>-</td> <td>-</td> <td>785</td> <td>-</td> <td>-</td> <td>1012</td> <td>1082</td> <td>1196</td> <td>1369</td> <td>1575</td> </tr> </table>												4528-5	-	-	-	-	785	-	-	1012	1082	1196	1369	1575						
			4528-5	-	-	-	-	785	-	-	1012	1082	1196	1369	1575																		
			<table border="1"> <tr> <th colspan="3">OVERALL DIMENSIONS</th> <th colspan="3">SEAT DIMENSIONS</th> <th colspan="3">BACK DIMENSIONS</th> </tr> <tr> <th>W</th> <th>D</th> <th>H</th> <th>W</th> <th>D</th> <th>H</th> <th>W</th> <th>H</th> </tr> <tr> <td>25</td> <td>39</td> <td>39</td> <td>22</td> <td>19.5</td> <td>17-22</td> <td>19</td> <td>19-21</td> </tr> </table>			OVERALL DIMENSIONS			SEAT DIMENSIONS			BACK DIMENSIONS			W	D	H	W	D	H	W	H	25	39	39	22	19.5	17-22	19	19-21	<p><b>RTA 2</b> </p>		
			OVERALL DIMENSIONS			SEAT DIMENSIONS			BACK DIMENSIONS																								
W	D	H	W	D	H	W	H																										
25	39	39	22	19.5	17-22	19	19-21																										
 <p><b>LB Task</b> w/Adj. Teardrop Arms COM Yardage: 1.75 Freight Class: 150 Product Weight (lbs.): 41 Cubic Feet Per Carton: 7</p>	 <p><b>ADJUSTMENTS</b> (2) Pneumatic seat height (8) Seat depth</p>	<p><b>Ergonomic Features:</b> C, E, H, M, N, Q</p>	<table border="1"> <tr> <td>4528-6</td> <td>-</td> <td>-</td> <td>-</td> <td>-</td> <td>611</td> <td>-</td> <td>-</td> <td>836</td> <td>907</td> <td>1022</td> <td>1195</td> <td>1400</td> </tr> </table>												4528-6	-	-	-	-	611	-	-	836	907	1022	1195	1400						
			4528-6	-	-	-	-	611	-	-	836	907	1022	1195	1400																		
			<table border="1"> <tr> <th colspan="3">OVERALL DIMENSIONS</th> <th colspan="3">SEAT DIMENSIONS</th> <th colspan="3">BACK DIMENSIONS</th> </tr> <tr> <th>W</th> <th>D</th> <th>H</th> <th>W</th> <th>D</th> <th>H</th> <th>W</th> <th>H</th> </tr> <tr> <td>26.5</td> <td>25</td> <td>41</td> <td>22</td> <td>17-18.5</td> <td>16.5-21.5</td> <td>19</td> <td>21</td> </tr> </table>			OVERALL DIMENSIONS			SEAT DIMENSIONS			BACK DIMENSIONS			W	D	H	W	D	H	W	H	26.5	25	41	22	17-18.5	16.5-21.5	19	21	<p><b>RTA 2</b> </p>		
			OVERALL DIMENSIONS			SEAT DIMENSIONS			BACK DIMENSIONS																								
W	D	H	W	D	H	W	H																										
26.5	25	41	22	17-18.5	16.5-21.5	19	21																										
 <p><b>LB Operator</b> Armless COM Yardage: 1.75 Freight Class: 150 Product Weight (lbs.): 41 Cubic Feet Per Carton: 7</p>	 <p><b>ADJUSTMENTS</b> (2) Pneumatic seat height (3) Back angle (4) Seat angle Free floating seat and back.</p>	<p><b>Ergonomic Features:</b> C, D, F, G, M, N</p>	<table border="1"> <tr> <td>4529-5</td> <td>-</td> <td>-</td> <td>-</td> <td>-</td> <td>640</td> <td>-</td> <td>-</td> <td>867</td> <td>938</td> <td>1050</td> <td>1224</td> <td>1429</td> </tr> </table>												4529-5	-	-	-	-	640	-	-	867	938	1050	1224	1429						
			4529-5	-	-	-	-	640	-	-	867	938	1050	1224	1429																		
			<table border="1"> <tr> <th colspan="3">OVERALL DIMENSIONS</th> <th colspan="3">SEAT DIMENSIONS</th> <th colspan="3">BACK DIMENSIONS</th> </tr> <tr> <th>W</th> <th>D</th> <th>H</th> <th>W</th> <th>D</th> <th>H</th> <th>W</th> <th>H</th> </tr> <tr> <td>26.5</td> <td>25</td> <td>41</td> <td>22</td> <td>19.5</td> <td>17-22</td> <td>19</td> <td>19-21</td> </tr> </table>			OVERALL DIMENSIONS			SEAT DIMENSIONS			BACK DIMENSIONS			W	D	H	W	D	H	W	H	26.5	25	41	22	19.5	17-22	19	19-21	<p><b>RTA 2</b> </p>		
			OVERALL DIMENSIONS			SEAT DIMENSIONS			BACK DIMENSIONS																								
W	D	H	W	D	H	W	H																										
26.5	25	41	22	19.5	17-22	19	19-21																										

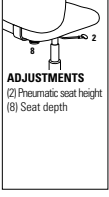

DESCRIPTION	FEATURES	MODEL#	STANDARD FABRIC GRADES												
			1	2	3	4	5	6	7	8	9	10	11	12	
 <p><b>LB Task</b> Armless COM Yardage: 1.75 Freight Class: 150 Product Weight (lbs.): 34 Cubic Feet Per Carton: 7</p>	 <p><b>ADJUSTMENTS</b> (2) Pneumatic seat height (8) Seat depth</p>	4529-6	-	-	-	-	496	-	-	723	793	906	1079	1285	
			OVERALL DIMENSIONS			SEAT DIMENSIONS			BACK DIMENSIONS						
			W	D	H	W	D	H	W	H					
			22.5	25	41	22	17-18.5	16.5-21.5	19	21					
	Ergonomic Features: C, E, M, N	RTA 2													

TRADITIONAL™



model 3720



model 3722

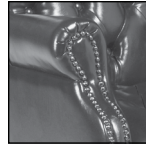

**Standard Feature**  
Attractive brass-colored nail head trim is standard on all models



model 3747

STANDARD FEATURES

- Tilter chairs are standard with a traditional style wood capped steel base.
- All models are Tufted design with brass-colored nail head trim and vinyl bumper guards. Pneumatic seat height adjustment and tilt tension control.
- **C1** casters are standard.
- All models ship fully assembled in the box.

OPTIONAL FEATURES

- Optional ballistic nylon outer back fabric available. Resistant to impact damage. Available in Black Only (**BKB**). Add \$15.
- Wood base, arms and frames are available in Absolute (**AAM**), Black (**BKM**), Cherry (**ACM**), Espresso Cafe (**ECM**), English Oak (**EOM**), Fruitwood (**TFM**), Gray (**HGM**), Honey (**AHM**), Mahogany (**TMM**), Maple (**AVM**), Medium Walnut (**MWM**), Night (**ASM**), Shaker Cherry (**SKM**), Walnut (**TWM**), WC Cream (**WTM**), White (**WHM**) and Winter Cherry (**WCM**). Please Specify. Genuine maple faced veneers and solids are used.
- For availability of chair series in Fabric, Vinyl or Leather, please contact a Global Sales Representative. Some restrictions apply.
- Tilter models can be ordered with an optional Black nylon base upon request, at no upcharge.
- Please refer to the "Casters Selection" section of the price book for caster options. Optional casters may be priced higher than the standard casters for your chair and the difference will be charged. Lower priced optional casters will not be credited.
- For hard surface flooring casters. Please Specify **C9R**, Add \$51.

DESCRIPTION	FEATURES	MODEL#	STANDARD FABRIC GRADES											
			1	2	3	4	5	6	7	8	9	10	11	12



**HB Tilter** Queen Anne Style  
COM Yardage: 4.75  
Freight Class: 250  
Product Weight (lbs.): 64  
Cubic Feet Per Carton: 22.25

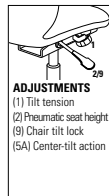

\*Fabrics Limited, See notes  
  
Ergonomic Features:  
A, C, M, N, S

<b>3720</b>	1213	1338	--	--	1800	1879	--	2417	2587	2918	3364	3923
-------------	------	------	----	----	------	------	----	------	------	------	------	------

OVERALL DIMENSIONS			SEAT DIMENSIONS			BACK DIMENSIONS	
W	D	H	W	D	H	W	H

29	30	44.5	19.5	19.5	19-23	19	26
----	----	------	------	------	-------	----	----

**RTA 00**



**ArmChair** Banker's Style  
COM Yardage: 2  
Freight Class: 250  
Product Weight (lbs.): 31  
Cubic Feet Per Carton: 11

\*Fabrics Limited, See notes  
  
Ergonomic Features:  
M, N

<b>3722</b>	608	663	--	--	854	890	--	1118	1189	1326	1517	1749
-------------	-----	-----	----	----	-----	-----	----	------	------	------	------	------

<b>3722C</b> with casters	648	702	--	--	898	929	--	1157	1230	1367	1556	1792
------------------------------	-----	-----	----	----	-----	-----	----	------	------	------	------	------

OVERALL DIMENSIONS			SEAT DIMENSIONS			BACK DIMENSIONS	
W	D	H	W	D	H	W	H

25	22.5	31	25	18	19.5	23	11
----	------	----	----	----	------	----	----

**RTA 00**



**High Back Armchair** Queen Anne Style  
COM Yardage: 4.75  
Freight Class: 250  
Product Weight (lbs.): 50  
Cubic Feet Per Carton: 22.25







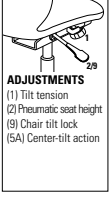

\*Fabrics Limited, See notes  
  
Ergonomic Features:  
M, N

<b>3725</b>	1032	1158	--	--	1622	1697	--	2238	2408	2737	3184	3742
-------------	------	------	----	----	------	------	----	------	------	------	------	------

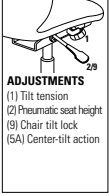
OVERALL DIMENSIONS			SEAT DIMENSIONS			BACK DIMENSIONS	
W	D	H	W	D	H	W	H

29	29	43	19	19	18	19	26
----	----	----	----	----	----	----	----

**RTA 00**

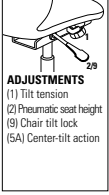
DESCRIPTION	FEATURES	MODEL#	STANDARD FABRIC GRADES													
			1	2	3	4	5	6	7	8	9	10	11	12		
 <p><b>HB Tilter</b> Martha Washington Style COM Yardage: 3 Freight Class: 250 Product Weight (lbs.): 50 Cubic Feet Per Carton: 20.25</p>	 <p><b>ADJUSTMENTS</b> (1) Tilt tension (2) Pneumatic seat height (9) Chair tilt lock (5A) Center-tilt action</p>	<b>3730</b>	1172	1251	--	--	1543	1593	--	1933	2041	2248	2529	2882		
			<b>OVERALL DIMENSIONS</b>			<b>SEAT DIMENSIONS</b>			<b>BACK DIMENSIONS</b>							
			<b>W</b>	<b>D</b>	<b>H</b>	<b>W</b>	<b>D</b>	<b>H</b>	<b>W</b>	<b>H</b>						
			25	27	39	18	18	17.5-21.5	19	23						
*Fabrics Limited, See notes		Ergonomic Features: A, C, M, N, S		<b>RTA 00</b>												
 <p><b>LB Tilter</b> Martha Washington Style COM Yardage: 2.75 Freight Class: 250 Product Weight (lbs.): 45 Cubic Feet Per Carton: 15.50</p>	 <p><b>ADJUSTMENTS</b> (1) Tilt tension (2) Pneumatic seat height (9) Chair tilt lock (5A) Center-tilt action</p>	<b>3731</b>	1087	1159	--	--	1428	1470	--	1783	1883	2073	2332	2656		
			<b>OVERALL DIMENSIONS</b>			<b>SEAT DIMENSIONS</b>			<b>BACK DIMENSIONS</b>							
			<b>W</b>	<b>D</b>	<b>H</b>	<b>W</b>	<b>D</b>	<b>H</b>	<b>W</b>	<b>H</b>						
			25.5	26	36	18	18	17.5-21.5	19	18						
*Fabrics Limited, See notes		Ergonomic Features: A, C, M, N, S		<b>RTA 00</b>												
 <p><b>LB Armchair</b> Martha Washington Style COM Yardage: 2.75 Freight Class: 300 Product Weight (lbs.): 28 Cubic Feet Per Carton: 15.50</p>	 <p><b>ADJUSTMENTS</b> (1) Tilt tension (2) Pneumatic seat height (9) Chair tilt lock (5A) Center-tilt action</p>	<b>3732</b>	901	974	--	--	1242	1285	--	1598	1697	1887	2147	2469		
			<b>OVERALL DIMENSIONS</b>			<b>SEAT DIMENSIONS</b>			<b>BACK DIMENSIONS</b>							
			<b>W</b>	<b>D</b>	<b>H</b>	<b>W</b>	<b>D</b>	<b>H</b>	<b>W</b>	<b>H</b>						
			25.5	24.5	34	20	18	19	19	18						
*Fabrics Limited, See notes		Ergonomic Features: M, N		<b>RTA 00</b>												
 <p><b>HB Armchair</b> Martha Washington Style COM Yardage: 3 Freight Class: 300 Product Weight (lbs.): 32 Cubic Feet Per Carton: 20.25</p>	 <p><b>ADJUSTMENTS</b> (1) Tilt tension (2) Pneumatic seat height (9) Chair tilt lock (5A) Center-tilt action</p>	<b>3735</b>	987	1064	--	--	1356	1406	--	1746	1856	2063	2345	2698		
			<b>OVERALL DIMENSIONS</b>			<b>SEAT DIMENSIONS</b>			<b>BACK DIMENSIONS</b>							
			<b>W</b>	<b>D</b>	<b>H</b>	<b>W</b>	<b>D</b>	<b>H</b>	<b>W</b>	<b>H</b>						
			25	27.5	39.5	20	18	19	19	22.5						
*Fabrics Limited, See notes		Ergonomic Features: M, N		<b>RTA 00</b>												
 <p><b>LB Tilter</b> Martha Washington Style COM Yardage: 2.75 Freight Class: 250 Product Weight (lbs.): 45 Cubic Feet Per Carton: 15.50</p>	 <p><b>ADJUSTMENTS</b> (1) Tilt tension (2) Pneumatic seat height (9) Chair tilt lock (5A) Center-tilt action</p>	<b>3741</b>	1102	1174	--	--	1442	1485	--	1798	1898	2088	2347	2671		
			<b>OVERALL DIMENSIONS</b>			<b>SEAT DIMENSIONS</b>			<b>BACK DIMENSIONS</b>							
			<b>W</b>	<b>D</b>	<b>H</b>	<b>W</b>	<b>D</b>	<b>H</b>	<b>W</b>	<b>H</b>						
			25.5	26	36	20	18	17.5-21.5	19	18						
*Fabrics Limited, See notes		Ergonomic Features: A, C, M, N, S		<b>RTA 00</b>												

DESCRIPTION	FEATURES	MODEL#	STANDARD FABRIC GRADES													
			1	2	3	4	5	6	7	8	9	10	11	12		
 <b>LB Armchair</b> Martha Washington Style COM Yardage: 2.75 Freight Class: 300 Product Weight (lbs.): 28 Cubic Feet Per Carton: 15.50	*Fabrics Limited, See notes  Ergonomic Features: M, N	<b>3742</b>	917	991	--	--	1258	1302	--	1615	1713	1904	2162	2485		
			OVERALL DIMENSIONS			SEAT DIMENSIONS			BACK DIMENSIONS							
			W	D	H	W	D	H	W	H						
			25	34.5	34.5	20	18	19	19	18						
						<b>RTA 00</b>										

DESCRIPTION	FEATURES	MODEL#	STANDARD FABRIC GRADES													
			1	2	3	4	5	6	7	8	9	10	11	12		
 <b>HB Armchair</b> Martha Washington Style COM Yardage: 3 Freight Class: 300 Product Weight (lbs.): 26 Cubic Feet Per Carton: 20.25	*Fabrics Limited, See notes  Ergonomic Features: M, N	<b>3745</b>	1003	1082	--	--	1375	1425	--	1765	1872	2080	2361	2717		
			OVERALL DIMENSIONS			SEAT DIMENSIONS			BACK DIMENSIONS							
			W	D	H	W	D	H	W	H						
			25	27.5	39.5	20	18	19	19	22.5						
						<b>RTA 00</b>										

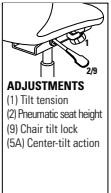
DESCRIPTION	FEATURES	MODEL#	STANDARD FABRIC GRADES													
			1	2	3	4	5	6	7	8	9	10	11	12		
 <b>MB Tilter</b> Martha Washington Style COM Yardage: 3 Freight Class: 300 Product Weight (lbs.): 40 Cubic Feet Per Carton: 20.25	 <b>ADJUSTMENTS</b> (1) Tilt tension (2) Pneumatic seat height (9) Chair tilt lock (5A) Center-tilt action	<b>3746</b>	1087	1166	--	--	1458	1506	--	1849	1956	2162	2446	2799		
			OVERALL DIMENSIONS			SEAT DIMENSIONS			BACK DIMENSIONS							
			W	D	H	W	D	H	W	H						
			26.5	29	38	20	18	17-21	20	24						
						<b>RTA 00</b>										

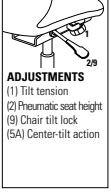
DESCRIPTION	FEATURES	MODEL#	STANDARD FABRIC GRADES													
			1	2	3	4	5	6	7	8	9	10	11	12		
 <b>MB Tilter</b> Martha Washington Style COM Yardage: 3 Freight Class: 250 Product Weight (lbs.): 46 Cubic Feet Per Carton: 20.25	 <b>ADJUSTMENTS</b> (1) Tilt tension (2) Pneumatic seat height (9) Chair tilt lock (5A) Center-tilt action	<b>3747</b>	1068	1147	--	--	1439	1489	--	1830	1937	2145	2428	2779		
			OVERALL DIMENSIONS			SEAT DIMENSIONS			BACK DIMENSIONS							
			W	D	H	W	D	H	W	H						
			25.5	28	38	20	18	17-21	20	24						
						<b>RTA 00</b>										

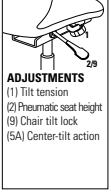
DESCRIPTION	FEATURES	MODEL#	STANDARD FABRIC GRADES													
			1	2	3	4	5	6	7	8	9	10	11	12		
 <b>HB Tilter</b> Judge's Style COM Yardage: 5 Freight Class: 250 Product Weight (lbs.): 61 Cubic Feet Per Carton: 28.25	 <b>ADJUSTMENTS</b> (1) Tilt tension (2) Pneumatic seat height (9) Chair tilt lock (5A) Center-tilt action	<b>3760</b>	1350	1482	--	--	1969	2048	--	2617	2797	3142	3615	4200		
			OVERALL DIMENSIONS			SEAT DIMENSIONS			BACK DIMENSIONS							
			W	D	H	W	D	H	W	H						
			29	32	48	20.5	18.5	18-22	20.5	26						
						<b>RTA 00</b>										

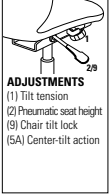
DESCRIPTION	FEATURES	MODEL#	STANDARD FABRIC GRADES											
			1	2	3	4	5	6	7	8	9	10	11	12
 <p><b>HB Tilter</b> Judge's Style                      COM Yardage: 4.75                      Freight Class: 250                      Product Weight (lbs.): 70                      Cubic Feet Per Carton: 28.25</p>	 <p><b>ADJUSTMENTS</b>                      (1) Tilt tension                      (2) Pneumatic seat height                      (3) Chair tilt lock                      (5A) Center-tilt action</p>	<b>3766</b>	1380	1505	--	--	1969	2044	--	2584	2755	3084	3533	4090
			OVERALL DIMENSIONS			SEAT DIMENSIONS			BACK DIMENSIONS					
			W	D	H	W	D	H	W	H				
			29	32	48	20.5	18.5	18-22	20.5	26				
			<b>RTA 00</b>											

\*Fabrics Limited, See notes  
 Ergonomic Features:  
 A, C, M, N, S

TRIUMPH™



model 3650-3

model 3651-3



**Lumbar Support**







Adjusted in and out by turning the knob and vertically by moving up and down the slider.

**STANDARD FEATURES**

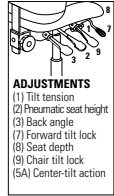
- Contemporary seating series featuring exceptional comfort, support and adjustment.
- Standard with adjustable height, forward swept arms with "sliding armcaps" (G1).
- Outer back knob can be adjusted in and out for lumbar support and vertically for optimal positioning.
- Frame is standard with a polished aluminum arched base and accentuated with polished aluminum back trim.
- Side activated sliding seat depth adjustment (MD), is standard on both control mechanisms. Provides 2" of seat depth adjustment.
- C1 casters are standard.

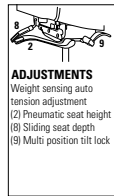
**OPTIONAL FEATURES**

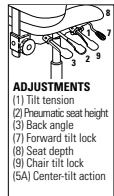
- For hard surface flooring please specify C9R and Add \$51.
- All models are available in Fabric, Vinyl, Leather/Mock Leather and Leather at the same grade pricing below. Not available in Imprint and Renewal.
- Please refer to the "Casters Selection" section of the price book for caster options.
- Please refer to "Cylinder Selection" section of the price book for additional cylinder options.
- For fully assembled in box, please specify SU. Add \$55.

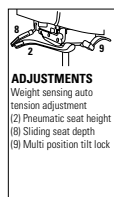
DESCRIPTION	FEATURES	MODEL#	STANDARD FABRIC GRADES												
			1	2	3	4	5	6	7	8	9	10	11	12	
 <p><b>HB Multi-Tilter</b> COM Yardage: 2 Freight Class: 250 Product Weight (lbs.): 66 Cubic Feet Per Carton: 23.50</p>	 <p><b>ADJUSTMENTS</b> (1) Tilt tension (2) Pneumatic seat height (3) Back angle (7) Forward tilt lock (8) Seat depth (9) Chair tilt lock (5A) Center-tilt action</p>	3650-3	1207	1322	1363	1428	1520	1553	1631	1783	1857	1999	2190	2430	
			<b>OVERALL DIMENSIONS</b>			<b>SEAT DIMENSIONS</b>			<b>BACK DIMENSIONS</b>						
			<b>W</b>	<b>D</b>	<b>H</b>	<b>W</b>	<b>D</b>	<b>H</b>	<b>W</b>	<b>H</b>					
	26	25	46.5	21	18-20.5	17-21	20	27							
				<b>RTA 00</b>											
	Adjustable Lumbar Support		Ergonomic Features: A, B, C, D, E, F, G, H, M, N, Q, R, S, V												
 <p><b>HB Weight Sensing Synchro - Tilter</b> COM Yardage: 2 Freight Class: 250 Product Weight (lbs.): 66 Cubic Feet Per Carton: 23.50</p>	 <p><b>ADJUSTMENTS</b> Weight sensing auto tension adjustment (2) Pneumatic seat height (8) Sliding seat depth (9) Multi-position tilt lock</p>	3650-8	1207	1322	1363	1428	1520	1553	1631	1783	1857	1999	2190	2430	
			<b>OVERALL DIMENSIONS</b>			<b>SEAT DIMENSIONS</b>			<b>BACK DIMENSIONS</b>						
			<b>W</b>	<b>D</b>	<b>H</b>	<b>W</b>	<b>D</b>	<b>H</b>	<b>W</b>	<b>H</b>					
	26	25	46.5	21	18-20.5	17-21	20	27							
				<b>RTA 00</b>											
	Adjustable Lumbar Support		Ergonomic Features: A, B, C, D, E, H, L, M, N, Q, R, V												
 <p><b>MB Multi - Tilter</b> COM Yardage: 1.75 Freight Class: 250 Product Weight (lbs.): 64 Cubic Feet Per Carton: 20.50</p>	 <p><b>ADJUSTMENTS</b> (1) Tilt tension (2) Pneumatic seat height (3) Back angle (7) Forward tilt lock (8) Seat depth (9) Chair tilt lock (5A) Center-tilt action</p>	3651-3	1181	1294	1337	1401	1494	1526	1605	1758	1831	1973	2163	2405	
			<b>OVERALL DIMENSIONS</b>			<b>SEAT DIMENSIONS</b>			<b>BACK DIMENSIONS</b>						
			<b>W</b>	<b>D</b>	<b>H</b>	<b>W</b>	<b>D</b>	<b>H</b>	<b>W</b>	<b>H</b>					
	26	25	39.5	21	18-20.5	17-21	20	21							
				<b>RTA 00</b>											
	Adjustable Lumbar Support		Ergonomic Features: A, B, C, D, E, F, G, H, M, N, Q, R, S, V												
 <p><b>MB Weight Sensing Synchro - Tilter</b> COM Yardage: 1.75 Freight Class: 250 Product Weight (lbs.): 64 Cubic Feet Per Carton: 20.50</p>	 <p><b>ADJUSTMENTS</b> Weight sensing auto tension adjustment (2) Pneumatic seat height (8) Sliding seat depth (9) Multi-position tilt lock</p>	3651-8	1181	1294	1337	1401	1494	1526	1605	1758	1831	1973	2163	2405	
			<b>OVERALL DIMENSIONS</b>			<b>SEAT DIMENSIONS</b>			<b>BACK DIMENSIONS</b>						
			<b>W</b>	<b>D</b>	<b>H</b>	<b>W</b>	<b>D</b>	<b>H</b>	<b>W</b>	<b>H</b>					
	26	25	39.5	21	18-20.5	17-21	20	21							
				<b>RTA 00</b>											
	Adjustable Lumbar Support		Ergonomic Features: A, B, C, D, E, H, L, M, N, Q, R, V												

TRUFORM™



model 5450-3



model 5451-3

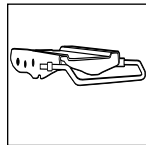

**Multi-Depth Mechanism**  
Seat depth option is available on multi-tilter models. (see notes for more details)

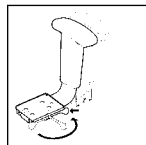

**Vari-Width (WA)**  
Width Adjustable Arm Extensions is standard when order with adjustable height arms.

STANDARD FEATURES

- Sixteen different models available, all featuring gently curved, streamlined seat and back cushions
- Standard with adjustable height **SC** arms.
- All models are standard with a high rise, injection molded base, standard in black.
- All models are shipped partially **KD**.
- **C1** casters are standard.

OPTIONAL FEATURES

- Memory foam is available as an option, specify **MF**. Add \$84
- Seat depth is standard on models 5450-3, 5450-8, 5451-0, 5451-3.
- An optional polished aluminum base is available, specify **ALU**. Add \$121.
- Please refer to "Arms Selection" section of the price book for arm options.
- Please refer to "Cylinder Selection" section of the price book for additional cylinder options.
- Please refer to the "Casters Selection" section of the price book for caster options. Optional casters may be priced higher than the standard casters for your chair and the difference will be charged. Lower priced optional casters will not be credited.
- For hard surface flooring please specify **C9R** and Add \$51.
- Upholstery in vinyl is limited to polyurethane vinyls which include Allante FFree. Some wrinkling of the materials on the upper left and right corner of the back is normal and should be expected.
- Not available in Leather or Leather/Mock Leather combination.
- For fully assembled in box, please specify **SU**. Add \$55.

DESCRIPTION FEATURES MODEL# STANDARD FABRIC GRADES



**HB Multi - Tilter**  
COM Yardage: 2  
Freight Class: 125  
Product Weight (lbs.): 63  
Cubic Feet Per Carton: 10.50

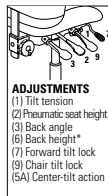

**ADJUSTMENTS**  
(1) Tilt tension  
(2) Pneumatic seat height  
(3) Back angle  
(6) Back height\*  
(7) Forward tilt lock  
(9) Chair tilt lock  
(5A) Center-tilt action

Ergonomic Features:  
A, B, C, D, F, G, H, M, N, Q, S

	1	2	3	4	5	6	7	8	9	10	11	12
<b>5450-3</b>	709	764	804	867	955	987	1064	1212	1284	1423	1607	1841

OVERALL DIMENSIONS			SEAT DIMENSIONS			BACK DIMENSIONS	
W	D	H	W	D	H	W	H
26	25	42	20	18-20.5	16.5-20.5	20	23.5-26



**HB Tilter**  
COM Yardage: 2  
Freight Class: 150  
Product Weight (lbs.): 45  
Cubic Feet Per Carton: 10.50

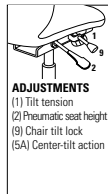

**ADJUSTMENTS**  
(1) Tilt tension  
(2) Pneumatic seat height  
(9) Chair tilt lock  
(5A) Center-tilt action

Ergonomic Features:  
A, B, C, J, M, N

	1	2	3	4	5	6	7	8	9	10	11	12
<b>5450-4</b>	630	682	725	788	877	908	985	1133	1205	1342	1528	1761

OVERALL DIMENSIONS			SEAT DIMENSIONS			BACK DIMENSIONS	
W	D	H	W	D	H	W	H
26	25	42	20	18-20.5	16.5-20.5	20	23-26



**HB Task**  
COM Yardage: 2  
Freight Class: 250  
Product Weight (lbs.): 39  
Cubic Feet Per Carton: 10.50

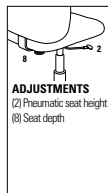









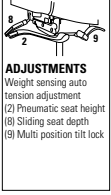

**ADJUSTMENTS**  
(2) Pneumatic seat height  
(8) Seat depth

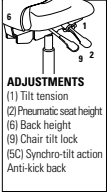
Ergonomic Features:  
C, E, H, M, N, Q

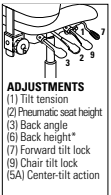

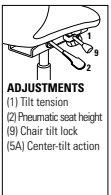

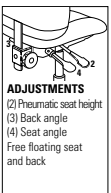
	1	2	3	4	5	6	7	8	9	10	11	12
<b>5450-6</b>	580	633	676	739	828	860	937	1084	1155	1292	1480	1712

OVERALL DIMENSIONS			SEAT DIMENSIONS			BACK DIMENSIONS	
W	D	H	W	D	H	W	H
26	25	41.5	20	18-20.5	16-20	20	23.5-26

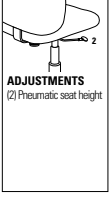

DESCRIPTION	FEATURES	MODEL#	STANDARD FABRIC GRADES													
			1	2	3	4	5	6	7	8	9	10	11	12		
 <p><b>HB Weight Sensing Synchro - Tilter</b> COM Yardage: 2 Freight Class: 125 Product Weight (lbs.): 59 Cubic Feet Per Carton: 10.50</p>	 <p><b>ADJUSTMENTS</b> (1) Weight sensing auto tension adjustment (2) Pneumatic seat height (8) Sliding seat depth (9) Multi-position tilt lock</p>	<b>5450-8</b>	709	761	803	865	951	981	1058	1204	1273	1407	1590	1817		
		<b>OVERALL DIMENSIONS</b>			<b>SEAT DIMENSIONS</b>			<b>BACK DIMENSIONS</b>								
		<b>W</b>	<b>D</b>	<b>H</b>	<b>W</b>	<b>D</b>	<b>H</b>	<b>W</b>	<b>H</b>							
		26	25	41.5	20	18-20.5	16.5-20.5	20	23.5-26							
			<b>RTA 2</b>													
 <p><b>MB Synchro - Tilter w/Back Angle Adjustment</b> COM Yardage: 1.75 Freight Class: 150 Product Weight (lbs.): 60 Cubic Feet Per Carton: 10.50</p>	 <p><b>ADJUSTMENTS</b> (1) Tilt tension (2) Pneumatic seat height (6) Back height (9) Chair tilt lock (5C) Synchro-tilt action Anti-kick back</p>	<b>5451-0</b>	680	727	765	818	897	923	991	1121	1183	1303	1466	1669		
		<b>OVERALL DIMENSIONS</b>			<b>SEAT DIMENSIONS</b>			<b>BACK DIMENSIONS</b>								
		<b>W</b>	<b>D</b>	<b>H</b>	<b>W</b>	<b>D</b>	<b>H</b>	<b>W</b>	<b>H</b>							
		26	25	38.5	20	18-20.5	17-21	20	23.5-26							
			<b>RTA 2</b>													
 <p><b>MB Multi - Tilter</b> COM Yardage: 1.75 Freight Class: 150 Product Weight (lbs.): 60 Cubic Feet Per Carton: 10.50</p>	 <p><b>ADJUSTMENTS</b> (1) Tilt tension (2) Pneumatic seat height (3) Back angle (6) Back height* (7) Forward tilt lock (9) Chair tilt lock (5A) Center-tilt action</p>	<b>5451-3</b>	680	727	765	818	897	923	991	1121	1183	1303	1466	1669		
		<b>OVERALL DIMENSIONS</b>			<b>SEAT DIMENSIONS</b>			<b>BACK DIMENSIONS</b>								
		<b>W</b>	<b>D</b>	<b>H</b>	<b>W</b>	<b>D</b>	<b>H</b>	<b>W</b>	<b>H</b>							
		26	25	38.5	20	18-20.5	16.5-20.5	20	20-22.5							
			<b>RTA 2</b>													
 <p><b>MB Tilter</b> COM Yardage: 1.75 Freight Class: 150 Product Weight (lbs.): 43 Cubic Feet Per Carton: 10.50</p>	 <p><b>ADJUSTMENTS</b> (1) Tilt tension (2) Pneumatic seat height (9) Chair tilt lock (5A) Center-tilt action</p>	<b>5451-4</b>	601	648	683	739	816	845	912	1041	1104	1223	1387	1590		
		<b>OVERALL DIMENSIONS</b>			<b>SEAT DIMENSIONS</b>			<b>BACK DIMENSIONS</b>								
		<b>W</b>	<b>D</b>	<b>H</b>	<b>W</b>	<b>D</b>	<b>H</b>	<b>W</b>	<b>H</b>							
		26	25	38.5	20	18-20.5	16.5-20.5	20	20-22.5							
			<b>RTA 2</b>													
 <p><b>MB Operator</b> COM Yardage: 1.75 Freight Class: 150 Product Weight (lbs.): 45 Cubic Feet Per Carton: 10.50</p>	 <p><b>ADJUSTMENTS</b> (2) Pneumatic seat height (3) Back angle (4) Seat angle Free floating seat and back</p>	<b>5451-5</b>	675	721	757	811	890	918	985	1115	1178	1297	1461	1663		
		<b>OVERALL DIMENSIONS</b>			<b>SEAT DIMENSIONS</b>			<b>BACK DIMENSIONS</b>								
		<b>W</b>	<b>D</b>	<b>H</b>	<b>W</b>	<b>D</b>	<b>H</b>	<b>W</b>	<b>H</b>							
		26	25	38.5	20	18-20.5	16.5-20.5	20	20-22.5							
			<b>RTA 2</b>													

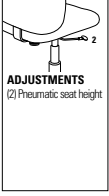

DESCRIPTION	FEATURES	MODEL#	STANDARD FABRIC GRADES											
			1	2	3	4	5	6	7	8	9	10	11	12
 <p><b>MB Drafting Stool Armless</b> COM Yardage: 1.75 Freight Class: 250 Product Weight (lbs.): 38 Cubic Feet Per Carton: 10.50</p>	 <p><b>ADJUSTMENTS</b> (2) Pneumatic seat height</p>	<b>5457-6</b>	807	853	891	945	1023	1049	1119	1248	1310	1430	1594	1796
			<b>OVERALL DIMENSIONS</b>			<b>SEAT DIMENSIONS</b>			<b>BACK DIMENSIONS</b>					
			<b>W</b>	<b>D</b>	<b>H</b>	<b>W</b>	<b>D</b>	<b>H</b>	<b>W</b>	<b>H</b>				
			20	25	47	20	17.5-19	22-30	20	20				
			<b>RTA 2</b>											
 <p><b>MB Drafting Stool</b> COM Yardage: 1.75 Freight Class: 150 Product Weight (lbs.): 44 Cubic Feet Per Carton: 10.50</p>	 <p><b>ADJUSTMENTS</b> (2) Pneumatic seat height</p>	<b>5458-6</b>	943	988	1025	1080	1157	1185	1253	1382	1444	1563	1728	1932
			<b>OVERALL DIMENSIONS</b>			<b>SEAT DIMENSIONS</b>			<b>BACK DIMENSIONS</b>					
			<b>W</b>	<b>D</b>	<b>H</b>	<b>W</b>	<b>D</b>	<b>H</b>	<b>W</b>	<b>H</b>				
			26	25	47	20	17.5-19	22-30	20	20				
			<b>RTA 2</b>											

TYE™



model 1950-4 (3N)

model 1951-4 (3N)

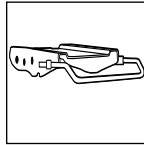

**Multi-Depth Mechanism**

Seat depth option is available on multi-tilter models. (see notes for more details)



model 1953

**STANDARD FEATURES**

- Contemporary mesh fabric and upholstered panels are used on chair backs.
- Standard with adjustable height T-arms with curved urethane armcaps (3N) in Black Only, (except model 1953 which has a fixed height version of this same arm style). All models (except armchair) are standard with a five-legged, injection molded "spider" base.
- C65 casters are standard.
- Seat and back panels will be upholstered in the same fabric unless otherwise specified.
- Seat depth and pneumatic seat height adjustments. Tilt tension adjustment with tilt lock.
- Mesh available in Black only.
- Not available in leather or leather/mock leather combination.
- Available in all standard Global textiles except Jenny. (Jenny is available on the seat only.)

**OPTIONAL FEATURES**

- Please refer to "Arms Selection" section of the price book for arm options.
- Please refer to the "Casters Selection" section of the price book for caster options. Optional casters may be priced higher than the standard casters for your chair and the difference will be charged. Lower priced optional casters will not be credited.
- For hard surface flooring please specify C65R and Add \$51.
- For fully assembled in box, please specify SU. Add \$55.

DESCRIPTION	FEATURES	MODEL#	STANDARD TEXTILE GRADES											
-------------	----------	--------	-------------------------	--	--	--	--	--	--	--	--	--	--	--



**HB Synchro - Tilter**  
COM Yardage: 1.50  
Freight Class: 150  
Product Weight (lbs.): 53  
Cubic Feet Per Carton: 11

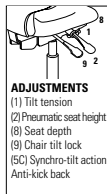

**ADJUSTMENTS**  
(1) Tilt tension  
(2) Pneumatic seat height  
(8) Seat depth  
(9) Chair tilt lock  
(5C) Synchro-tilt action  
Anti-kick back

Ergonomic Features:  
A, B, C, E, H, L, M, N

	1	2	3	4	5	6	7	8	9	10	11	12
<b>1950-1</b>	776	818	849	-	-	-	-	-	-	-	-	-

OVERALL DIMENSIONS			SEAT DIMENSIONS			BACK DIMENSIONS	
W	D	H	W	D	H	W	H
25	26	45	21	19-20.5	17.5-21.5	19.5	27

RTA 2



**HB Multi - Tilter**  
COM Yardage: 1.50  
Freight Class: 150  
Product Weight (lbs.): 52  
Cubic Feet Per Carton: 11

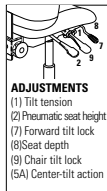

**ADJUSTMENTS**  
(1) Tilt tension  
(2) Pneumatic seat height  
(7) Forward tilt lock  
(8) Seat depth  
(9) Chair tilt lock  
(5A) Center-tilt action

Ergonomic Features:  
A, B, C, E, F, H, M, N, S

	1	2	3	4	5	6	7	8	9	10	11	12
<b>1950-3</b>	761	801	832	-	-	-	-	-	-	-	-	-

OVERALL DIMENSIONS			SEAT DIMENSIONS			BACK DIMENSIONS	
W	D	H	W	D	H	W	H
25	26	45	21	19-20.5	17.5-21.5	19.5	27

RTA 2



**HB Tilter**  
COM Yardage: 1.50  
Freight Class: 150  
Product Weight (lbs.): 49  
Cubic Feet Per Carton: 11

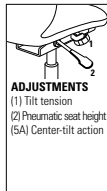

**ADJUSTMENTS**  
(1) Tilt tension  
(2) Pneumatic seat height  
(5A) Center-tilt action









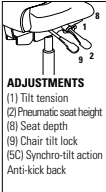

Ergonomic Features:  
A, C, E, H, M, N

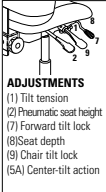

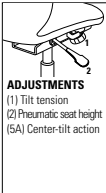

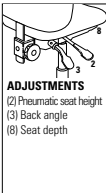

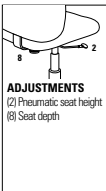

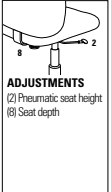

	1	2	3	4	5	6	7	8	9	10	11	12
<b>1950-4</b>	646	685	717	-	-	-	-	-	-	-	-	-

OVERALL DIMENSIONS			SEAT DIMENSIONS			BACK DIMENSIONS	
W	D	H	W	D	H	W	H
25	26	45.5	21	19-20.5	16.5-20.5	19.5	27

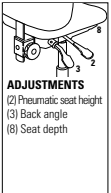
RTA 2

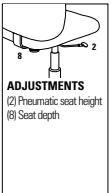

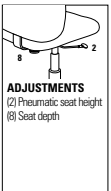
DESCRIPTION	FEATURES	MODEL#	STANDARD TEXTILE GRADES													
			1	2	3	4	5	6	7	8	9	10	11	12		
 <p><b>MB Synchro - Tilter</b> COM Yardage: 1.25 Freight Class: 150 Product Weight (lbs.): 51 Cubic Feet Per Carton: 10.50</p>	 <p><b>ADJUSTMENTS</b> (1) Tilt tension (2) Pneumatic seat height (8) Seat depth (9) Chair tilt lock (5C) Synchro-tilt action Anti-kick back</p>	1951-1	751	785	812	-	-	-	-	-	-	-	-	-		
			<b>OVERALL DIMENSIONS</b>			<b>SEAT DIMENSIONS</b>			<b>BACK DIMENSIONS</b>							
			<b>W</b>	<b>D</b>	<b>H</b>	<b>W</b>	<b>D</b>	<b>H</b>	<b>W</b>	<b>H</b>						
			25	26	40.5	21	19-20.5	17-21	19.5	23						
			<b>RTA 2</b>													
 <p><b>MB Multi - Tilter</b> COM Yardage: 1.25 Freight Class: 150 Product Weight (lbs.): 50 Cubic Feet Per Carton: 10.50</p>	 <p><b>ADJUSTMENTS</b> (1) Tilt tension (2) Pneumatic seat height (7) Forward tilt lock (8) Seat depth (9) Chair tilt lock (5A) Center-tilt action</p>	1951-3	734	768	795	-	-	-	-	-	-	-	-	-		
			<b>OVERALL DIMENSIONS</b>			<b>SEAT DIMENSIONS</b>			<b>BACK DIMENSIONS</b>							
			<b>W</b>	<b>D</b>	<b>H</b>	<b>W</b>	<b>D</b>	<b>H</b>	<b>W</b>	<b>H</b>						
			25.	26.	40.5	21	19-20.5	17-21	19.5	23						
			<b>RTA 2</b>													
 <p><b>MB Tilter</b> COM Yardage: 1.25 Freight Class: 150 Product Weight (lbs.): 47 Cubic Feet Per Carton: 10.50</p>	 <p><b>ADJUSTMENTS</b> (1) Tilt tension (2) Pneumatic seat height (5A) Center-tilt action</p>	1951-4	618	651	679	-	-	-	-	-	-	-	-	-		
			<b>OVERALL DIMENSIONS</b>			<b>SEAT DIMENSIONS</b>			<b>BACK DIMENSIONS</b>							
			<b>W</b>	<b>D</b>	<b>H</b>	<b>W</b>	<b>D</b>	<b>H</b>	<b>W</b>	<b>H</b>						
			25	26	41	21	19-20.5	17-21	19.5	23						
			<b>RTA 2</b>													
 <p><b>MB Posture Task w/Arms</b> COM Yardage: 1.25 Freight Class: 150 Product Weight (lbs.): 45 Cubic Feet Per Carton: 9.25</p>	 <p><b>ADJUSTMENTS</b> (2) Pneumatic seat height (3) Back angle (8) Seat depth</p>	1951-7	670	703	731	-	-	-	-	-	-	-	-	-		
			<b>OVERALL DIMENSIONS</b>			<b>SEAT DIMENSIONS</b>			<b>BACK DIMENSIONS</b>							
			<b>W</b>	<b>D</b>	<b>H</b>	<b>W</b>	<b>D</b>	<b>H</b>	<b>W</b>	<b>H</b>						
			25	26	40	21	19-20.5	16-20	19.5	23						
			<b>RTA 2</b>													
 <p><b>LB Task w/Arms</b> COM Yardage: 1 Freight Class: 150 Product Weight (lbs.): 43 Cubic Feet Per Carton: 9.25</p>	 <p><b>ADJUSTMENTS</b> (2) Pneumatic seat height (8) Seat depth</p>	1952-6	536	563	585	-	-	-	-	-	-	-	-	-		
			<b>OVERALL DIMENSIONS</b>			<b>SEAT DIMENSIONS</b>			<b>BACK DIMENSIONS</b>							
			<b>W</b>	<b>D</b>	<b>H</b>	<b>W</b>	<b>D</b>	<b>H</b>	<b>W</b>	<b>H</b>						
			25	26	35.	21	19-20.5	17-20	19.5	16						
			<b>RTA 2</b>													

DESCRIPTION	FEATURES	MODEL#	STANDARD TEXTILE GRADES														
			1	2	3	4	5	6	7	8	9	10	11	12			
 <b>Armchair</b> COM Yardage: 1 Freight Class: 250 Product Weight (lbs.): 36 Cubic Feet Per Carton: 10.25	Ergonomic Features: M, N	1953	479	509	527	-	-	-	-	-	-	-	-	-	-	-	
			<b>OVERALL DIMENSIONS</b>			<b>SEAT DIMENSIONS</b>			<b>BACK DIMENSIONS</b>								
			W	D	H	W	D	H	W	H							
			27	23	35	21	18.5	18	19.5	18							
											RTA 1 						
 <b>LB Task Armless</b> COM Yardage: 1 Freight Class: 150 Product Weight (lbs.): 37 Cubic Feet Per Carton: 9.25	 <b>ADJUSTMENTS</b> (2) Pneumatic seat height (8) Seat depth	1954-6	460	492	519	-	-	-	-	-	-	-	-	-	-		
			<b>OVERALL DIMENSIONS</b>			<b>SEAT DIMENSIONS</b>			<b>BACK DIMENSIONS</b>								
			W	D	H	W	D	H	W	H							
			25	26	35	21	19-20.5	17-22	19.5	16							
											RTA 2 						
 <b>MB Posture Task</b> Armless COM Yardage: 1.25 Freight Class: 150 Product Weight (lbs.): 39 Cubic Feet Per Carton: 9.25	 <b>ADJUSTMENTS</b> (2) Pneumatic seat height (3) Back angle (8) Seat depth	1957-7	595	629	655	-	-	-	-	-	-	-	-	-			
			<b>OVERALL DIMENSIONS</b>			<b>SEAT DIMENSIONS</b>			<b>BACK DIMENSIONS</b>								
			W	D	H	W	D	H	W	H							
			25	26	40	21	19-20.5	16-20	19.5	23							
											RTA 2 						
 <b>LB Task Drafting Chair</b> COM Yardage: 1 Freight Class: 150 Product Weight (lbs.): 47 Cubic Feet Per Carton: 9.25	 <b>ADJUSTMENTS</b> (2) Pneumatic seat height (8) Seat depth	1922-6	642	669	691	-	-	-	-	-	-	-	-	-			
			<b>OVERALL DIMENSIONS</b>			<b>SEAT DIMENSIONS</b>			<b>BACK DIMENSIONS</b>								
			W	D	H	W	D	H	W	H							
			25	26	44.5	21	19-20.5	24-34	19.5	16							
											RTA 2 						
 <b>LB Task Drafting Chair</b> Armless COM Yardage: 1 Freight Class: 150 Product Weight (lbs.): 40 Cubic Feet Per Carton: 9.25	 <b>ADJUSTMENTS</b> (2) Pneumatic seat height (8) Seat depth	1924-6	564	591	611	-	-	-	-	-	-	-	-				
			<b>OVERALL DIMENSIONS</b>			<b>SEAT DIMENSIONS</b>			<b>BACK DIMENSIONS</b>								
			W	D	H	W	D	H	W	H							
			25	26	44.5	21	19-20.5	24-34	19.5	16							
											RTA 2 						

VION



model 6321-8



model 6331-8



**Optional Live Lumbar Support Pad (LS)**

Lumbar Pad is spring loaded, providing pressure sensitive depth adjustment and 3 inches of height adjustment.



model 6322-4 (C)

VION FINISHES - TASK SEATING				
Back Frame	Base	Specify Code	Arm Option	Specify Code
Black	Black	BK	Adj. "T" arm (Black) Adj. "T" arm, fixed armcap (Black) Adj. "T" arm (Black, Chrome accent) Adj. "T" arm, fixed armcap (Black, Chrome accent)	AS AF AC AD
Black	Polished Aluminum	BA Add \$121	Adj. "T" arm (Fog) Adj. "T" arm, fixed armcap (Fog) Adj. "T" arm (Fog, Chrome accent) Adj. "T" arm, fixed armcap (Fog, Chrome accent)	FA FF FC CF
Fog	Fog	FG Add \$55	Fixed "C" arm (Black) Fixed "C" arm (Fog) Fixed "C" arm (Polished Aluminum)	C CC CA - Add \$147

\* All arms have Black SSU Armcaps.

**STANDARD FEATURES**

- Vion is a comprehensive seating series offering a family of models to address multiple applications: task, management, conference, guest, heavy duty 24/7 and drafting stools.
- Vion Heavy Duty models can be found in the Heavy Duty section of the price book (page 368).
- Series offers Mid and High Back models with either a mesh or upholstered back.
- Five different control mechanism options to suit all price points and ergonomic requirements.
- All models are standard with height and width adjustable arms (AS) that feature a front to back sliding armcap.
- Standard with Global's high quality Soft Descent™ pneumatic lift which slowly and gently lowers the seat height of the chair, making it easy to obtain the desired position.
- Side activated sliding seat depth adjustment (MD) is standard on multi-tilter, synchro tilter with back angle adjustment and weight sensing synchro tilter control mechanisms.
- Standard with Black five prong, injection molded, fiberglass reinforced nylon Governor base (B7) with dual wheel carpet casters (C1).
- Mesh back models are available in 10 colors: Aqua (MS75), Black (MS69), Black Cherry (MS76), Blue (MS72), Dust (MS77), Ivory (MS78), Natural (MS74), Paprika (MS79), Rope (MS73) and Stone (MS71).
- Upholstered back models feature black fabric Jenny (JN02) on the back side as standard.
- Upholstery options: fabric or vinyl only. Not available in leather, leather/mock leather combination or Crescent fabric.

**OPTIONAL FEATURES**

- Upholstered back models offer a Matching Outer (MO) upholstery option. Due to the Additional material needed, these models are listed separately and are priced differently than the standard upholstered back models.
- Optional lumbar pad can be added at the time of order. Please specify (LS) and add \$28. Lumbar pad can also be ordered after sale as a kit, specify model 6339 at 28 list. The lumbar pad is adjustable up to 3".
- Seat available in memory foam. Please specify (MF) and add \$84.
- Petite seat models (2" shorter and 2" narrower than the standard size seat) are available. Please specify by adding (P) to the model code. No upcharge.
- For hard surface flooring casters, please specify (C9R). Add \$51.
- Two featured "T" arm options that include height and width adjusting arms, one with sliding arm caps (AS) and one without sliding arm caps (AF). Also, available is a stylish fixed urethane arm (C) for conference/management environments.
- For additional arm/caster options, please refer to the Arm and Caster section (page 371). Optional casters may be priced higher than the standard casters for your chair and the difference will be charged. Lower priced optional casters will not be credited.
- Please refer to "Cylinder Selection" section of the price book for additional cylinder options.
- For fully assembled in box, please specify SU. Add \$55.







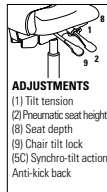

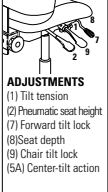

**Vion guest chairs**

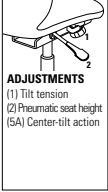

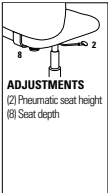

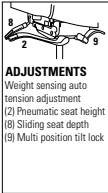

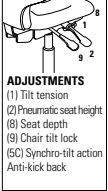



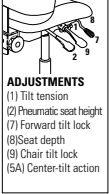

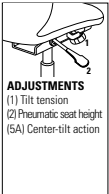

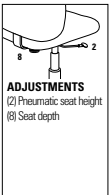

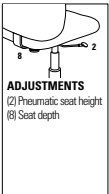

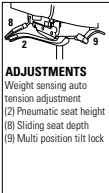

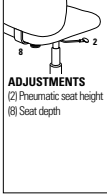

For Vion guest chairs, please see page Z31

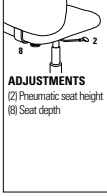
DESCRIPTION	FEATURES	MODEL#	STANDARD TEXTILE GRADES												
			1	2	3	4	5	6	7	8	9	10	11	12	
 <p><b>HB Synchro - Tilter w/Back Angle Adjustment</b> COM Yardage: 1 Freight Class: 150 Product Weight (lbs.): 60 Cubic Feet Per Carton: 10.50</p>	 <p><b>ADJUSTMENTS</b> (1) Tilt tension (2) Pneumatic seat height (3) Seat depth (4) Chair-tilt lock (5C) Synchro-tilt action Anti-kick back</p>	6321-0	733	759	779	810	852	869	906	979	1014	1081	1173	1286	
			<b>OVERALL DIMENSIONS</b>			<b>SEAT DIMENSIONS</b>			<b>BACK DIMENSIONS</b>						
			<b>W</b>	<b>D</b>	<b>H</b>	<b>W</b>	<b>D</b>	<b>H</b>	<b>W</b>	<b>H</b>					
			25.5	24	41.5	20	17-20	17.5-22.5	18.5	23					

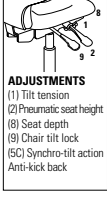

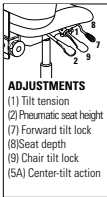

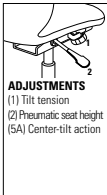





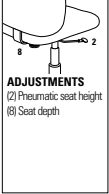

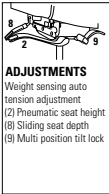

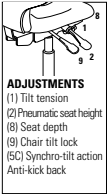

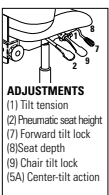

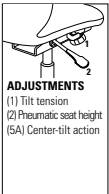

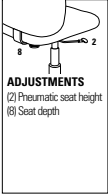

DESCRIPTION	FEATURES	MODEL#	STANDARD TEXTILE GRADES														
			1	2	3	4	5	6	7	8	9	10	11	12			
 <p><b>HB Multi - Tilter</b> COM Yardage: 1 Freight Class: 150 Product Weight (lbs.): 62 Cubic Feet Per Carton: 10.50</p>	 <p><b>ADJUSTMENTS</b> (1) Tilt tension (2) Pneumatic seat height (7) Forward tilt lock (8) Seat depth (9) Chair tilt lock (5A) Center-tilt action</p>	<p><b>6321-3</b></p>	733	759	779	810	852	869	906	979	1014	1081	1173	1286			
			<b>OVERALL DIMENSIONS</b>			<b>SEAT DIMENSIONS</b>			<b>BACK DIMENSIONS</b>								
			<b>W</b>	<b>D</b>	<b>H</b>	<b>W</b>	<b>D</b>	<b>H</b>	<b>W</b>		<b>H</b>						
			25.5	24	41	20	17-20	17.25-22.25	18.5		23						
<p><b>HB Multi - Tilter</b> COM Yardage: 1 Freight Class: 150 Product Weight (lbs.): 62 Cubic Feet Per Carton: 10.50</p>	<p>Mesh Back</p> <p>Ergonomic Features: A, B, C, E, F, G, H, M, N, Q, U, S</p>	<p><b>RTA 2</b></p> 															
			 <p><b>HB Tilter</b> COM Yardage: 1 Freight Class: 150 Product Weight (lbs.): 54 Cubic Feet Per Carton: 10.50</p>	 <p><b>ADJUSTMENTS</b> (1) Tilt tension (2) Pneumatic seat height (5A) Center-tilt action</p>	<p><b>6321-4</b></p>	656	682	703	734	776	793	830	903	938	1005	1096	1210
						<b>OVERALL DIMENSIONS</b>			<b>SEAT DIMENSIONS</b>			<b>BACK DIMENSIONS</b>					
						<b>W</b>	<b>D</b>	<b>H</b>	<b>W</b>	<b>D</b>	<b>H</b>	<b>W</b>		<b>H</b>			
25.5	24	39.25				20	17.5	16-21	18.5		23						
<p><b>HB Tilter</b> COM Yardage: 1 Freight Class: 150 Product Weight (lbs.): 54 Cubic Feet Per Carton: 10.50</p>	<p>Mesh Back</p> <p>Ergonomic Features: A, B, C, E, H, M, N, Q, S, U</p>	<p><b>RTA 2</b></p> 															
			 <p><b>HB Task</b> COM Yardage: 1 Freight Class: 150 Product Weight (lbs.): 49 Cubic Feet Per Carton: 10.50</p>	 <p><b>ADJUSTMENTS</b> (2) Pneumatic seat height (8) Seat depth</p>	<p><b>6321-6</b></p>	629	655	676	706	749	765	803	876	910	977	1069	1182
						<b>OVERALL DIMENSIONS</b>			<b>SEAT DIMENSIONS</b>			<b>BACK DIMENSIONS</b>					
						<b>W</b>	<b>D</b>	<b>H</b>	<b>W</b>	<b>D</b>	<b>H</b>	<b>W</b>		<b>H</b>			
25.5	24	39.25				20	17.5	17-22	18.5		23						
<p><b>HB Task</b> COM Yardage: 1 Freight Class: 150 Product Weight (lbs.): 49 Cubic Feet Per Carton: 10.50</p>	<p>Mesh Back</p> <p>Ergonomic Features: C, E, M, N, U</p>	<p><b>RTA 2</b></p> 															
			 <p><b>HB Weight Sensing Synchro - Tilter</b> COM Yardage: 1 Freight Class: 150 Product Weight (lbs.): 57 Cubic Feet Per Carton: 10.50</p>	 <p><b>ADJUSTMENTS</b> Weight sensing auto tension adjustment (2) Pneumatic seat height (8) Sliding seat depth (9) Multi position tilt lock</p>	<p><b>6321-8</b></p>	733	759	779	810	852	869	906	979	1014	1081	1173	1286
						<b>OVERALL DIMENSIONS</b>			<b>SEAT DIMENSIONS</b>			<b>BACK DIMENSIONS</b>					
						<b>W</b>	<b>D</b>	<b>H</b>	<b>W</b>	<b>D</b>	<b>H</b>	<b>W</b>		<b>H</b>			
25.5	24	40				20	17-20	16.5-21.5	18.5		23						
<p><b>HB Weight Sensing Synchro - Tilter</b> COM Yardage: 1 Freight Class: 150 Product Weight (lbs.): 57 Cubic Feet Per Carton: 10.50</p>	<p>Mesh Back</p> <p>Ergonomic Features: A, B, C, E, H, L, M, N, Q, U</p>	<p><b>RTA 2</b></p> 															
			 <p><b>MB Synchro - Tilter w/Back Angle Adjustment</b> COM Yardage: 1 Freight Class: 150 Product Weight (lbs.): 58 Cubic Feet Per Carton: 10.50</p>	 <p><b>ADJUSTMENTS</b> (1) Tilt tension (2) Pneumatic seat height (8) Seat depth (9) Chair tilt lock (5C) Synchro-tilt action Anti-kick back</p>	<p><b>6322-0</b></p>	695	720	741	772	814	831	868	941	976	1043	1135	1248
						<b>OVERALL DIMENSIONS</b>			<b>SEAT DIMENSIONS</b>			<b>BACK DIMENSIONS</b>					
						<b>W</b>	<b>D</b>	<b>H</b>	<b>W</b>	<b>D</b>	<b>H</b>	<b>W</b>		<b>H</b>			
25.5	24	39.5				20	17-20	17.5-22.5	18.5		21						
<p><b>MB Synchro - Tilter w/Back Angle Adjustment</b> COM Yardage: 1 Freight Class: 150 Product Weight (lbs.): 58 Cubic Feet Per Carton: 10.50</p>	<p>Mesh Back</p> <p>Ergonomic Features: A, B, C, E, G, H, L, M, N, Q, U</p>	<p><b>RTA 2</b></p> 															

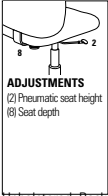
DESCRIPTION	FEATURES	MODEL#	STANDARD TEXTILE GRADES												
			1	2	3	4	5	6	7	8	9	10	11	12	
 <p><b>MB Multi - Tilter</b> COM Yardage: 1 Freight Class: 150 Product Weight (lbs.): 60 Cubic Feet Per Carton: 10.50</p>	 <p><b>ADJUSTMENTS</b> (1) Tilt tension (2) Pneumatic seat height (7) Forward tilt lock (8) Seat depth (9) Chair-tilt lock (5A) Center-tilt action</p>	<p>Mesh Back</p> <p>Ergonomic Features: A, B, C, E, F, G, H, M, N, Q, U, S</p>	6322-3	695	720	741	772	814	831	868	941	976	1043	1135	1248
			<b>OVERALL DIMENSIONS</b>			<b>SEAT DIMENSIONS</b>			<b>BACK DIMENSIONS</b>						
			<b>W</b>	<b>D</b>	<b>H</b>	<b>W</b>	<b>D</b>	<b>H</b>	<b>W</b>	<b>H</b>					
	25.5	24	39	20	17-20	17.25-22.25	18.5	21							
				<b>RTA 2</b>											
 <p><b>MB Tilter</b> COM Yardage: 1 Freight Class: 150 Product Weight (lbs.): 52 Cubic Feet Per Carton: 10.50</p>	 <p><b>ADJUSTMENTS</b> (1) Tilt tension (2) Pneumatic seat height (5A) Center-tilt action</p>	<p>Mesh Back</p> <p>Ergonomic Features: A, B, C, E, H, M, N, Q, S, U</p>	6322-4	617	644	665	696	738	754	792	865	900	967	1058	1172
			<b>OVERALL DIMENSIONS</b>			<b>SEAT DIMENSIONS</b>			<b>BACK DIMENSIONS</b>						
			<b>W</b>	<b>D</b>	<b>H</b>	<b>W</b>	<b>D</b>	<b>H</b>	<b>W</b>	<b>H</b>					
	25.5	24	37.5	20	17.5	16-21	18.5	21							
				<b>RTA 2</b>											
 <p><b>MB Task</b> COM Yardage: 1 Freight Class: 150 Product Weight (lbs.): 47 Cubic Feet Per Carton: 10.50</p>	 <p><b>ADJUSTMENTS</b> (2) Pneumatic seat height (8) Seat depth</p>	<p>Mesh Back</p> <p>Ergonomic Features: C, E, M, N, Q, U</p>	6322-6	596	623	643	673	716	733	770	843	878	944	1036	1150
			<b>OVERALL DIMENSIONS</b>			<b>SEAT DIMENSIONS</b>			<b>BACK DIMENSIONS</b>						
			<b>W</b>	<b>D</b>	<b>H</b>	<b>W</b>	<b>D</b>	<b>H</b>	<b>W</b>	<b>H</b>					
	25.5	24	37.5	20	17.5	17-22	18.5	21							
				<b>RTA 2</b>											
 <p><b>MB Task - Armless</b> COM Yardage: 1 Freight Class: 150 Product Weight (lbs.): 43 Cubic Feet Per Carton: 10.50</p>	 <p><b>ADJUSTMENTS</b> (2) Pneumatic seat height (8) Seat depth</p>	<p>Mesh Back</p> <p>Ergonomic Features: C, E, M, N, U</p>	6323-6	563	590	610	641	683	700	737	810	845	912	1004	1117
			<b>OVERALL DIMENSIONS</b>			<b>SEAT DIMENSIONS</b>			<b>BACK DIMENSIONS</b>						
			<b>W</b>	<b>D</b>	<b>H</b>	<b>W</b>	<b>D</b>	<b>H</b>	<b>W</b>	<b>H</b>					
	20	24	39.25	20	17.5	17-22	18.5	21							
				<b>RTA 2</b>											
 <p><b>MB Weight Sensing Synchro - Tilter</b> COM Yardage: 1 Freight Class: 150 Product Weight (lbs.): 55 Cubic Feet Per Carton: 10.50</p>	 <p><b>ADJUSTMENTS</b> Weight sensing auto tension adjustment (2) Pneumatic seat height (8) Sliding seat depth (9) Multi position tilt lock</p>	<p>Mesh Back</p> <p>Ergonomic Features: A, B, C, E, H, L, M, N, Q, U</p>	6322-8	695	720	741	772	814	831	868	941	976	1043	1135	1248
			<b>OVERALL DIMENSIONS</b>			<b>SEAT DIMENSIONS</b>			<b>BACK DIMENSIONS</b>						
			<b>W</b>	<b>D</b>	<b>H</b>	<b>W</b>	<b>D</b>	<b>H</b>	<b>W</b>	<b>H</b>					
	25.5	24	38	20	17-20	16.5-21.5	18.5	21							
				<b>RTA 2</b>											

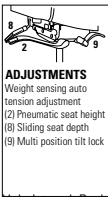
DESCRIPTION	FEATURES	MODEL#	STANDARD TEXTILE GRADES														
			1	2	3	4	5	6	7	8	9	10	11	12			
 <p><b>MB Drafting Stool - Task Armless</b> COM Yardage: 1 Freight Class: 150 Product Weight (lbs.): 44 Cubic Feet Per Carton: 10.50</p>	 <p><b>ADJUSTMENTS</b> (2) Pneumatic seat height (8) Seat depth</p>	<p>Mesh Back</p> <p>Ergonomic Features: C, E, M, N, U</p>	6327-6	629	656	677	707	750	767	804	877	912	978	1070	1185		
			<b>OVERALL DIMENSIONS</b>			<b>SEAT DIMENSIONS</b>			<b>BACK DIMENSIONS</b>								
			<b>W</b>	<b>D</b>	<b>H</b>	<b>W</b>	<b>D</b>	<b>H</b>	<b>W</b>	<b>H</b>							
			20	24	48.	20	17.5	23.5-33.5	18.5	21							
			<b>RTA 2</b>														
 <p><b>MB Drafting Stool - Task</b> COM Yardage: 1 Freight Class: 150 Product Weight (lbs.): 50 Cubic Feet Per Carton: 10.50</p>	 <p><b>ADJUSTMENTS</b> (2) Pneumatic seat height (8) Seat depth</p>	<p>Mesh Back</p> <p>Ergonomic Features: C, E, H, M, N, Q, U</p>	6328-6	710	737	758	788	831	847	884	957	992	1059	1151	1264		
			<b>OVERALL DIMENSIONS</b>			<b>SEAT DIMENSIONS</b>			<b>BACK DIMENSIONS</b>								
			<b>W</b>	<b>D</b>	<b>H</b>	<b>W</b>	<b>D</b>	<b>H</b>	<b>W</b>	<b>H</b>							
			25.5	24	48	20	17.5	23.5-33.5	18.5	21							
			<b>RTA 2</b>														
 <p><b>HB Synchro - Tilter w/Back Angle Adjustment</b> COM Yardage: 1.25 Freight Class: 150 Product Weight (lbs.): 61 Cubic Feet Per Carton: 10.50</p>	 <p><b>ADJUSTMENTS</b> (1) Tilt tension (2) Pneumatic seat height (8) Seat depth (9) Chair tilt lock (5C) Synchro-tilt action Anti-kick back</p>	<p>Upholstered Back</p> <p>Ergonomic Features: A, B, C, E, G, H, L, M, N, Q, U</p>	6331-0	831	865	889	927	982	1003	1049	1140	1183	1267	1382	1524		
			<b>OVERALL DIMENSIONS</b>			<b>SEAT DIMENSIONS</b>			<b>BACK DIMENSIONS</b>								
			<b>W</b>	<b>D</b>	<b>H</b>	<b>W</b>	<b>D</b>	<b>H</b>	<b>W</b>	<b>H</b>							
			25.5	24	41.5	20	17-20	17.5-22.5	18.5	23							
			<b>RTA 2</b>														
 <p><b>HB Multi - Tilter</b> COM Yardage: 1.25 Freight Class: 150 Product Weight (lbs.): 63 Cubic Feet Per Carton: 10.50</p>	 <p><b>ADJUSTMENTS</b> (1) Tilt tension (2) Pneumatic seat height (7) Forward tilt lock (8) Seat depth (9) Chair tilt lock (5A) Center-tilt action</p>	<p>Upholstered Back</p> <p>Ergonomic Features: A, B, C, E, F, G, H, M, N, Q, U, S</p>	6331-3	831	865	889	927	982	1003	1049	1140	1183	1267	1382	1524		
			<b>OVERALL DIMENSIONS</b>			<b>SEAT DIMENSIONS</b>			<b>BACK DIMENSIONS</b>								
			<b>W</b>	<b>D</b>	<b>H</b>	<b>W</b>	<b>D</b>	<b>H</b>	<b>W</b>	<b>H</b>							
			25.5	24	41	20	17-20	17.25-22.25	18.5	23							
			<b>RTA 2</b>														
 <p><b>HB Tilter</b> COM Yardage: 1.25 Freight Class: 150 Product Weight (lbs.): 55 Cubic Feet Per Carton: 10.50</p>	 <p><b>ADJUSTMENTS</b> (1) Tilt tension (2) Pneumatic seat height (5A) Center-tilt action</p>	<p>Upholstered Back</p> <p>Ergonomic Features: A, B, C, E, H, M, N, Q, S, U</p>	6331-4	743	777	803	841	896	915	961	1052	1096	1180	1295	1436		
			<b>OVERALL DIMENSIONS</b>			<b>SEAT DIMENSIONS</b>			<b>BACK DIMENSIONS</b>								
			<b>W</b>	<b>D</b>	<b>H</b>	<b>W</b>	<b>D</b>	<b>H</b>	<b>W</b>	<b>H</b>							
			25.5	24	39.25	20	17.5	16-21	18.5	23							
			<b>RTA 2</b>														

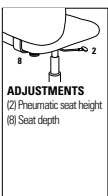

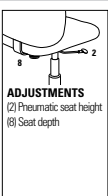
DESCRIPTION	FEATURES	MODEL#	STANDARD TEXTILE GRADES																																																																										
			1	2	3	4	5	6	7	8	9	10	11	12																																																															
 <p><b>HB Task</b> COM Yardage: 1.25 Freight Class: 150 Product Weight (lbs.): 49 Cubic Feet Per Carton: 10.50</p>	 <p><b>ADJUSTMENTS</b> (2) Pneumatic seat height (8) Seat depth</p>	<p>Upholstered Back</p> <p>Ergonomic Features: C, E, M, N</p>	<table border="1"> <tr> <td><b>6331-6</b></td> <td>721</td> <td>754</td> <td>779</td> <td>817</td> <td>872</td> <td>891</td> <td>939</td> <td>1029</td> <td>1073</td> <td>1157</td> <td>1272</td> <td>1414</td> </tr> <tr> <td><b>6331-6MO</b></td> <td>765</td> <td>816</td> <td>858</td> <td>919</td> <td>1006</td> <td>1037</td> <td>1113</td> <td>1258</td> <td>1327</td> <td>1462</td> <td>1645</td> <td>1873</td> </tr> <tr> <td colspan="3"><b>OVERALL DIMENSIONS</b></td> <td colspan="3"><b>SEAT DIMENSIONS</b></td> <td colspan="6"><b>BACK DIMENSIONS</b></td> </tr> <tr> <td><b>W</b></td> <td><b>D</b></td> <td><b>H</b></td> <td><b>W</b></td> <td><b>D</b></td> <td><b>H</b></td> <td><b>W</b></td> <td><b>D</b></td> <td><b>H</b></td> <td><b>W</b></td> <td><b>H</b></td> <td colspan="2"></td> </tr> <tr> <td>25.5</td> <td>24</td> <td>39.5</td> <td>20</td> <td>17.5</td> <td>17-22</td> <td>18.5</td> <td colspan="2">23</td> <td colspan="3"></td> </tr> </table>												<b>6331-6</b>	721	754	779	817	872	891	939	1029	1073	1157	1272	1414	<b>6331-6MO</b>	765	816	858	919	1006	1037	1113	1258	1327	1462	1645	1873	<b>OVERALL DIMENSIONS</b>			<b>SEAT DIMENSIONS</b>			<b>BACK DIMENSIONS</b>						<b>W</b>	<b>D</b>	<b>H</b>	<b>W</b>	<b>D</b>	<b>H</b>	<b>W</b>	<b>D</b>	<b>H</b>	<b>W</b>	<b>H</b>			25.5	24	39.5	20	17.5	17-22	18.5	23				
			<b>6331-6</b>	721	754	779	817	872	891	939	1029	1073	1157	1272	1414																																																														
			<b>6331-6MO</b>	765	816	858	919	1006	1037	1113	1258	1327	1462	1645	1873																																																														
			<b>OVERALL DIMENSIONS</b>			<b>SEAT DIMENSIONS</b>			<b>BACK DIMENSIONS</b>																																																																				
<b>W</b>	<b>D</b>	<b>H</b>	<b>W</b>	<b>D</b>	<b>H</b>	<b>W</b>	<b>D</b>	<b>H</b>	<b>W</b>	<b>H</b>																																																																			
25.5	24	39.5	20	17.5	17-22	18.5	23																																																																						
			<p><b>RTA 2</b> </p>																																																																										
 <p><b>HB Weight Sensing Synchro - Tilter</b> COM Yardage: 1.25 Freight Class: 150 Product Weight (lbs.): 58 Cubic Feet Per Carton: 10.50</p>	 <p><b>ADJUSTMENTS</b> Weight sensing auto tension adjustment (2) Pneumatic seat height (8) Sliding seat depth (9) Multi position tilt lock</p>	<p>Upholstered Back</p> <p>Ergonomic Features: A, B, C, E, H, L, M, N, Q, U</p>	<table border="1"> <tr> <td><b>6331-8</b></td> <td>831</td> <td>865</td> <td>889</td> <td>927</td> <td>982</td> <td>1003</td> <td>1049</td> <td>1140</td> <td>1183</td> <td>1267</td> <td>1382</td> <td>1524</td> </tr> <tr> <td><b>6331-8MO</b></td> <td>876</td> <td>926</td> <td>969</td> <td>1029</td> <td>1116</td> <td>1147</td> <td>1223</td> <td>1368</td> <td>1437</td> <td>1572</td> <td>1756</td> <td>1983</td> </tr> <tr> <td colspan="3"><b>OVERALL DIMENSIONS</b></td> <td colspan="3"><b>SEAT DIMENSIONS</b></td> <td colspan="6"><b>BACK DIMENSIONS</b></td> </tr> <tr> <td><b>W</b></td> <td><b>D</b></td> <td><b>H</b></td> <td><b>W</b></td> <td><b>D</b></td> <td><b>H</b></td> <td><b>W</b></td> <td><b>D</b></td> <td><b>H</b></td> <td><b>W</b></td> <td><b>H</b></td> <td colspan="2"></td> </tr> <tr> <td>25.5</td> <td>24</td> <td>40</td> <td>20</td> <td>17-20</td> <td>16.5-21.5</td> <td>18.5</td> <td colspan="2">23</td> <td colspan="3"></td> </tr> </table>												<b>6331-8</b>	831	865	889	927	982	1003	1049	1140	1183	1267	1382	1524	<b>6331-8MO</b>	876	926	969	1029	1116	1147	1223	1368	1437	1572	1756	1983	<b>OVERALL DIMENSIONS</b>			<b>SEAT DIMENSIONS</b>			<b>BACK DIMENSIONS</b>						<b>W</b>	<b>D</b>	<b>H</b>	<b>W</b>	<b>D</b>	<b>H</b>	<b>W</b>	<b>D</b>	<b>H</b>	<b>W</b>	<b>H</b>			25.5	24	40	20	17-20	16.5-21.5	18.5	23				
			<b>6331-8</b>	831	865	889	927	982	1003	1049	1140	1183	1267	1382	1524																																																														
			<b>6331-8MO</b>	876	926	969	1029	1116	1147	1223	1368	1437	1572	1756	1983																																																														
			<b>OVERALL DIMENSIONS</b>			<b>SEAT DIMENSIONS</b>			<b>BACK DIMENSIONS</b>																																																																				
<b>W</b>	<b>D</b>	<b>H</b>	<b>W</b>	<b>D</b>	<b>H</b>	<b>W</b>	<b>D</b>	<b>H</b>	<b>W</b>	<b>H</b>																																																																			
25.5	24	40	20	17-20	16.5-21.5	18.5	23																																																																						
			<p><b>RTA 2</b> </p>																																																																										
 <p><b>MB Synchro - Tilter w/Back Angle Adjustment</b> COM Yardage: 1.25 Freight Class: 150 Product Weight (lbs.): 59 Cubic Feet Per Carton: 10.50</p>	 <p><b>ADJUSTMENTS</b> (1) Tilt tension (8) Seat depth (9) Chair tilt lock (5C) Synchro-tilt action Anti-kick back</p>	<p>Upholstered Back</p> <p>Ergonomic Features: A, B, C, E, G, H, L, M, N, Q, U</p>	<table border="1"> <tr> <td><b>6332-0</b></td> <td>793</td> <td>827</td> <td>851</td> <td>889</td> <td>944</td> <td>964</td> <td>1011</td> <td>1102</td> <td>1145</td> <td>1229</td> <td>1344</td> <td>1486</td> </tr> <tr> <td><b>6332-0MO</b></td> <td>836</td> <td>891</td> <td>937</td> <td>1004</td> <td>1097</td> <td>1142</td> <td>1228</td> <td>1364</td> <td>1469</td> <td>1587</td> <td>1828</td> <td>2084</td> </tr> <tr> <td colspan="3"><b>OVERALL DIMENSIONS</b></td> <td colspan="3"><b>SEAT DIMENSIONS</b></td> <td colspan="6"><b>BACK DIMENSIONS</b></td> </tr> <tr> <td><b>W</b></td> <td><b>D</b></td> <td><b>H</b></td> <td><b>W</b></td> <td><b>D</b></td> <td><b>H</b></td> <td><b>W</b></td> <td><b>D</b></td> <td><b>H</b></td> <td><b>W</b></td> <td><b>H</b></td> <td colspan="2"></td> </tr> <tr> <td>25.5</td> <td>24</td> <td>39.5</td> <td>20</td> <td>17-20</td> <td>17.5-22.5</td> <td>18.5</td> <td colspan="2">21</td> <td colspan="3"></td> </tr> </table>												<b>6332-0</b>	793	827	851	889	944	964	1011	1102	1145	1229	1344	1486	<b>6332-0MO</b>	836	891	937	1004	1097	1142	1228	1364	1469	1587	1828	2084	<b>OVERALL DIMENSIONS</b>			<b>SEAT DIMENSIONS</b>			<b>BACK DIMENSIONS</b>						<b>W</b>	<b>D</b>	<b>H</b>	<b>W</b>	<b>D</b>	<b>H</b>	<b>W</b>	<b>D</b>	<b>H</b>	<b>W</b>	<b>H</b>			25.5	24	39.5	20	17-20	17.5-22.5	18.5	21				
			<b>6332-0</b>	793	827	851	889	944	964	1011	1102	1145	1229	1344	1486																																																														
			<b>6332-0MO</b>	836	891	937	1004	1097	1142	1228	1364	1469	1587	1828	2084																																																														
			<b>OVERALL DIMENSIONS</b>			<b>SEAT DIMENSIONS</b>			<b>BACK DIMENSIONS</b>																																																																				
<b>W</b>	<b>D</b>	<b>H</b>	<b>W</b>	<b>D</b>	<b>H</b>	<b>W</b>	<b>D</b>	<b>H</b>	<b>W</b>	<b>H</b>																																																																			
25.5	24	39.5	20	17-20	17.5-22.5	18.5	21																																																																						
			<p><b>RTA 2</b> </p>																																																																										
 <p><b>MB Multi - Tilter</b> COM Yardage: 1.25 Freight Class: 150 Product Weight (lbs.): 61 Cubic Feet Per Carton: 10.50</p>	 <p><b>ADJUSTMENTS</b> (1) Tilt tension (2) Pneumatic seat height (7) Forward tilt lock (8) Seat depth (9) Chair tilt lock (5A) Center-tilt action</p>	<p>Upholstered Back</p> <p>Ergonomic Features: A, B, C, E, F, G, H, M, N, Q, U, S</p>	<table border="1"> <tr> <td><b>6332-3</b></td> <td>793</td> <td>827</td> <td>851</td> <td>889</td> <td>944</td> <td>964</td> <td>1011</td> <td>1102</td> <td>1145</td> <td>1229</td> <td>1344</td> <td>1486</td> </tr> <tr> <td><b>6332-3MO</b></td> <td>836</td> <td>891</td> <td>937</td> <td>1004</td> <td>1097</td> <td>1142</td> <td>1228</td> <td>1364</td> <td>1469</td> <td>1587</td> <td>1828</td> <td>2084</td> </tr> <tr> <td colspan="3"><b>OVERALL DIMENSIONS</b></td> <td colspan="3"><b>SEAT DIMENSIONS</b></td> <td colspan="6"><b>BACK DIMENSIONS</b></td> </tr> <tr> <td><b>W</b></td> <td><b>D</b></td> <td><b>H</b></td> <td><b>W</b></td> <td><b>D</b></td> <td><b>H</b></td> <td><b>W</b></td> <td><b>D</b></td> <td><b>H</b></td> <td><b>W</b></td> <td><b>H</b></td> <td colspan="2"></td> </tr> <tr> <td>25.5</td> <td>24</td> <td>39</td> <td>20</td> <td>17-20</td> <td>17.25-22.25</td> <td>18.5</td> <td colspan="2">21</td> <td colspan="3"></td> </tr> </table>												<b>6332-3</b>	793	827	851	889	944	964	1011	1102	1145	1229	1344	1486	<b>6332-3MO</b>	836	891	937	1004	1097	1142	1228	1364	1469	1587	1828	2084	<b>OVERALL DIMENSIONS</b>			<b>SEAT DIMENSIONS</b>			<b>BACK DIMENSIONS</b>						<b>W</b>	<b>D</b>	<b>H</b>	<b>W</b>	<b>D</b>	<b>H</b>	<b>W</b>	<b>D</b>	<b>H</b>	<b>W</b>	<b>H</b>			25.5	24	39	20	17-20	17.25-22.25	18.5	21				
			<b>6332-3</b>	793	827	851	889	944	964	1011	1102	1145	1229	1344	1486																																																														
			<b>6332-3MO</b>	836	891	937	1004	1097	1142	1228	1364	1469	1587	1828	2084																																																														
			<b>OVERALL DIMENSIONS</b>			<b>SEAT DIMENSIONS</b>			<b>BACK DIMENSIONS</b>																																																																				
<b>W</b>	<b>D</b>	<b>H</b>	<b>W</b>	<b>D</b>	<b>H</b>	<b>W</b>	<b>D</b>	<b>H</b>	<b>W</b>	<b>H</b>																																																																			
25.5	24	39	20	17-20	17.25-22.25	18.5	21																																																																						
			<p><b>RTA 2</b> </p>																																																																										
 <p><b>MB Tilter</b> COM Yardage: 1.25 Freight Class: 150 Product Weight (lbs.): 53 Cubic Feet Per Carton: 10.50</p>	 <p><b>ADJUSTMENTS</b> (1) Tilt tension (2) Pneumatic seat height (5A) Center-tilt action</p>	<p>Upholstered Back</p> <p>Ergonomic Features: A, B, C, E, H, M, N, Q, S, U</p>	<table border="1"> <tr> <td><b>6332-4</b></td> <td>710</td> <td>743</td> <td>769</td> <td>807</td> <td>862</td> <td>881</td> <td>927</td> <td>1018</td> <td>1062</td> <td>1146</td> <td>1261</td> <td>1403</td> </tr> <tr> <td><b>6332-4MO</b></td> <td>755</td> <td>807</td> <td>848</td> <td>909</td> <td>995</td> <td>1027</td> <td>1103</td> <td>1248</td> <td>1318</td> <td>1452</td> <td>1635</td> <td>1864</td> </tr> <tr> <td colspan="3"><b>OVERALL DIMENSIONS</b></td> <td colspan="3"><b>SEAT DIMENSIONS</b></td> <td colspan="6"><b>BACK DIMENSIONS</b></td> </tr> <tr> <td><b>W</b></td> <td><b>D</b></td> <td><b>H</b></td> <td><b>W</b></td> <td><b>D</b></td> <td><b>H</b></td> <td><b>W</b></td> <td><b>D</b></td> <td><b>H</b></td> <td><b>W</b></td> <td><b>H</b></td> <td colspan="2"></td> </tr> <tr> <td>25.5</td> <td>24</td> <td>37.5</td> <td>20</td> <td>17.5</td> <td>16-21</td> <td>18.5</td> <td colspan="2">21</td> <td colspan="3"></td> </tr> </table>												<b>6332-4</b>	710	743	769	807	862	881	927	1018	1062	1146	1261	1403	<b>6332-4MO</b>	755	807	848	909	995	1027	1103	1248	1318	1452	1635	1864	<b>OVERALL DIMENSIONS</b>			<b>SEAT DIMENSIONS</b>			<b>BACK DIMENSIONS</b>						<b>W</b>	<b>D</b>	<b>H</b>	<b>W</b>	<b>D</b>	<b>H</b>	<b>W</b>	<b>D</b>	<b>H</b>	<b>W</b>	<b>H</b>			25.5	24	37.5	20	17.5	16-21	18.5	21				
			<b>6332-4</b>	710	743	769	807	862	881	927	1018	1062	1146	1261	1403																																																														
			<b>6332-4MO</b>	755	807	848	909	995	1027	1103	1248	1318	1452	1635	1864																																																														
			<b>OVERALL DIMENSIONS</b>			<b>SEAT DIMENSIONS</b>			<b>BACK DIMENSIONS</b>																																																																				
<b>W</b>	<b>D</b>	<b>H</b>	<b>W</b>	<b>D</b>	<b>H</b>	<b>W</b>	<b>D</b>	<b>H</b>	<b>W</b>	<b>H</b>																																																																			
25.5	24	37.5	20	17.5	16-21	18.5	21																																																																						
			<p><b>RTA 2</b> </p>																																																																										

DESCRIPTION	FEATURES	MODEL#	STANDARD TEXTILE GRADES											
			1	2	3	4	5	6	7	8	9	10	11	12
 <p><b>MB Task</b> COM Yardage: 1.25 Freight Class: 150 Product Weight (lbs.): 48 Cubic Feet Per Carton: 10.50</p>	 <p><b>ADJUSTMENTS</b> (2) Pneumatic seat height (8) Seat depth</p> <p>Upholstered Back</p> <p>Ergonomic Features: C, E, M, N, Q, U</p>		1	2	3	4	5	6	7	8	9	10	11	12
		<b>6332-6</b>	689	723	748	786	841	861	907	998	1042	1125	1241	1382
		<b>6332-6MO</b>	734	785	827	887	974	1006	1081	1226	1296	1430	1613	1842
			<b>OVERALL DIMENSIONS</b>			<b>SEAT DIMENSIONS</b>			<b>BACK DIMENSIONS</b>					
			<b>W</b>	<b>D</b>	<b>H</b>	<b>W</b>	<b>D</b>	<b>H</b>	<b>W</b>	<b>H</b>				
			25.5	24	37.5	20	17.5	17-22	18.5	21				
												<p>RTA 2 </p>		
 <p><b>MB Task - Armless</b> COM Yardage: 1.25 Freight Class: 150 Product Weight (lbs.): 42 Cubic Feet Per Carton: 10.50</p>	 <p><b>ADJUSTMENTS</b> (2) Pneumatic seat height (8) Seat depth</p> <p>Upholstered Back</p> <p>Ergonomic Features: C, E, M, N, U</p>		1	2	3	4	5	6	7	8	9	10	11	12
		<b>6333-6</b>	656	689	714	752	807	827	873	964	1008	1091	1207	1349
		<b>6333-6MO</b>	707	759	800	862	948	979	1054	1199	1269	1404	1588	1814
			<b>OVERALL DIMENSIONS</b>			<b>SEAT DIMENSIONS</b>			<b>BACK DIMENSIONS</b>					
			<b>W</b>	<b>D</b>	<b>H</b>	<b>W</b>	<b>D</b>	<b>H</b>	<b>W</b>	<b>H</b>				
			20	24	37.5	20	17.5	17-22	18.5	21				
												<p>RTA 2 </p>		
 <p><b>MB Weight Sensing Synchro - Tilter</b> COM Yardage: 1.25 Freight Class: 150 Product Weight (lbs.): 56 Cubic Feet Per Carton: 10.50</p>	 <p><b>ADJUSTMENTS</b> Weight sensing auto tension adjustment (2) Pneumatic seat height (8) Sliding seat depth (9) Multi position tilt lock</p> <p>Upholstered Back</p> <p>Ergonomic Features: A, B, C, E, H, L, M, N, Q, U</p>		1	2	3	4	5	6	7	8	9	10	11	12
		<b>6332-8</b>	793	827	851	889	944	964	1011	1102	1145	1229	1344	1486
		<b>6332-8MO</b>	836	891	937	1004	1097	1142	1228	1364	1469	1587	1828	2084
			<b>OVERALL DIMENSIONS</b>			<b>SEAT DIMENSIONS</b>			<b>BACK DIMENSIONS</b>					
			<b>W</b>	<b>D</b>	<b>H</b>	<b>W</b>	<b>D</b>	<b>H</b>	<b>W</b>	<b>H</b>				
			25.5	24	38	20	17-20	16.5-21.5	18.5	21				
												<p>RTA 2 </p>		
 <p><b>MB Drafting Stool - Task Armless</b> COM Yardage: 1.25 Freight Class: 150 Product Weight (lbs.): 45 Cubic Feet Per Carton: 10.50</p>	 <p><b>ADJUSTMENTS</b> (2) Pneumatic seat height (8) Seat depth</p> <p>Upholstered Back</p> <p>Ergonomic Features: C, E, M, N, U</p>		1	2	3	4	5	6	7	8	9	10	11	12
		<b>6337-6</b>	710	744	770	808	863	882	929	1019	1063	1147	1262	1404
		<b>6337-6MO</b>	759	810	851	913	999	1030	1106	1251	1321	1455	1638	1867
			<b>OVERALL DIMENSIONS</b>			<b>SEAT DIMENSIONS</b>			<b>BACK DIMENSIONS</b>					
			<b>W</b>	<b>D</b>	<b>H</b>	<b>W</b>	<b>D</b>	<b>H</b>	<b>W</b>	<b>H</b>				
			20	24	48	20	17.5	23.5-33.5	18.5	21				
												<p>RTA 2 </p>		
 <p><b>MB Drafting Stool - Task</b> COM Yardage: 1.25 Freight Class: 150 Product Weight (lbs.): 51 Cubic Feet Per Carton: 10.50</p>	 <p><b>ADJUSTMENTS</b> (2) Pneumatic seat height (8) Seat depth</p> <p>Upholstered Back</p> <p>Ergonomic Features: C, E, H, M, N, Q, U</p>		1	2	3	4	5	6	7	8	9	10	11	12
		<b>6338-6</b>	798	832	857	896	950	970	1016	1107	1151	1234	1350	1491
		<b>6338-6MO</b>	844	896	937	998	1084	1116	1191	1336	1406	1540	1724	1951
			<b>OVERALL DIMENSIONS</b>			<b>SEAT DIMENSIONS</b>			<b>BACK DIMENSIONS</b>					
			<b>W</b>	<b>D</b>	<b>H</b>	<b>W</b>	<b>D</b>	<b>H</b>	<b>W</b>	<b>H</b>				
			25.5	24	48	20	17.5	23.5-33.5	18.5	21				
												<p>RTA 2 </p>		

DESCRIPTION FEATURES MODEL# STANDARD TEXTILE GRADES

	1	2	3	4	5	6	7	8	9	10	11	12
6339	28	-	-	-	-	-	-	-	-	-	-	-

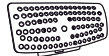

**Lumbar Pad Kit**  
COM Yardage: N/A  
Freight Class: 250  
Product Weight (lbs.): 0.5  
Cubic Feet Per Carton: 0.5

OVERALL DIMENSIONS			SEAT DIMENSIONS			BACK DIMENSIONS	
W	D	H	W	D	H	W	H
20	24	34.5	19	17.5	17.5	19	17

RTA 00



mesh back

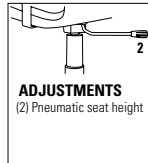

**ADJUSTMENTS**  
(2) Pneumatic seat height

Ergonomic features: M, N

**Armless Task**  
COM Yardage: 1  
Freight Class: 150  
Product Weight (lbs.): 25  
Cubic Feet Per Carton: 15.5

	1	2	3	4	5	6	7	8	9	10	11	12
6364-6	660	685	706	737	780	800	841	903	952	1006	1117	1235

OVERALL DIMENSIONS			SEAT DIMENSIONS			BACK DIMENSIONS	
W	D	H	W	D	H	W	H
19.5	24.5	33	19	18	16-21	19	17

RTA 00

1 per carton



mesh back

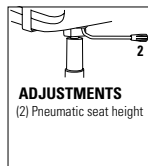

**ADJUSTMENTS**  
(2) Pneumatic seat height

Ergonomic features: M, N

**Armless Task w/Tablet**  
COM Yardage: 1  
Freight Class: 150  
Product Weight (lbs.): 25  
Cubic Feet Per Carton: 17.75

**Specify (L) left or (R) right tablet.**  
**(Example: 6364-6L or 6364-6R).**

RTA 00

1 per carton



upholstered back

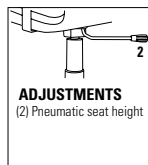

**ADJUSTMENTS**  
(2) Pneumatic seat height

Ergonomic features: M, N

**Armless Task**  
COM Yardage: 1.25  
Freight Class: 150  
Product Weight (lbs.): 25  
Cubic Feet Per Carton: 15.5

	1	2	3	4	5	6	7	8	9	10	11	12
6374-6	660	692	717	755	810	836	885	964	1025	1092	1231	1379

6374-6MO	703	754	796	857	944	986	1064	1191	1287	1395	1618	1854
----------	-----	-----	-----	-----	-----	-----	------	------	------	------	------	------

OVERALL DIMENSIONS			SEAT DIMENSIONS			BACK DIMENSIONS	
W	D	H	W	D	H	W	H
19.5	24.5	33	19	18	16-21	19	17

RTA 00

1 per carton



upholstered back

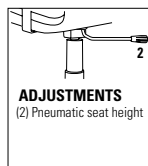

**ADJUSTMENTS**  
(2) Pneumatic seat height

Ergonomic features: M, N

**Armless Task w/Tablet**  
COM Yardage: 1.25  
Freight Class: 150  
Product Weight (lbs.): 25  
Cubic Feet Per Carton: 17.75

**Specify (L) left or (R) right tablet.**  
**(Example: 6374-6L or 6374-6R,**  
**6374-6MOL or 6374-6MOR).**

RTA 00

1 per carton

	1	2	3	4	5	6	7	8	9	10	11	12
6374-6	898	931	955	994	1048	1074	1123	1201	1263	1331	1469	1618

6374-6MO	941	992	1034	1095	1182	1224	1302	1428	1525	1633	1856	2092
----------	-----	-----	------	------	------	------	------	------	------	------	------	------

OVERALL DIMENSIONS			SEAT DIMENSIONS			BACK DIMENSIONS	
W	D	H	W	D	H	W	H
23.5	29	33	19	18	16-21	19	17

WEEV



model 2220-3



model 2221-4

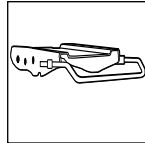

**Multi-Depth Mechanism**  
Seat depth is standard on Multi-tilter and Synchro-Tilter models. (see notes for more details)

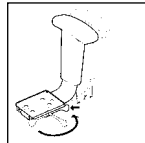

**Vari-Width (WA)**  
Width Adjustable Arm Extensions is standard when order with adjustable height arms.







STANDARD FEATURES



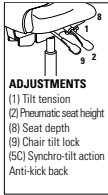

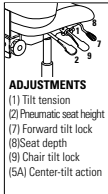

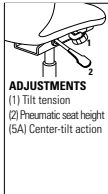

- A beautiful, breathable mesh, functional task seating series, at affordable pricing.
- Weev series includes six mechanisms, a Synchro-Tilter with Back Angle, Weight Sensing Synchro-Tilter, Multi-Tilter, Tilter, and Task.
- The Black mesh for the back of the chair is woven to breathe and give as the user leans into it removing pressure points along the spine.
- The lumbar support built into the design of the back is flexible and reshapes itself to match and support the user's body profile.
- Side activated sliding seat depth adjustment (**MD**), is standard on Multi-Tilters and Synchro-Tilters providing 2" of seat depth adjustment.
- Height and width (**WA**) adjustable GL arms. Armcaps are soft to the touch Self-Skinned Urethane. Armcaps are depth adjustable (slide forward and backward) to suit user preference.
- Vari-Width (**WA**) Width Adjustable Arm Extensions are standard, allowing the arms to move away from the seat by 2" on each side to allow space for broader hip widths.

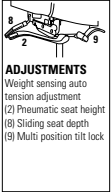

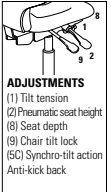

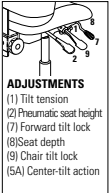

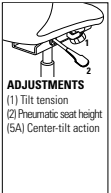

- Five legged, injection molded, fiberglass reinforced, nylon base **B7B** is standard.
- **C1** dual wheel carpet casters are standard.

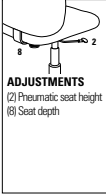
OPTIONAL FEATURES

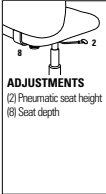
- Please refer to the "Arm Selection" section of the price book for arm options.
- Please refer to "Cylinder Selection" section of the price book for additional cylinder options.
- Optional Memory Foam available on Seats. Please specify **MF** and Add \$84.
- For optional polished Aluminum base (**B7A**) Please specify **ALU** base. Add \$121.
- For hard surface flooring casters, Please Specify **C9R**. Add \$51.
- Please refer to the "Casters Selection" section of the price book for caster options. Optional casters may be priced higher than the standard casters for your chair and the difference will be charged. Lower priced optional casters will not be credited.
- For fully assembled in box, please specify **SU**. Add \$55.

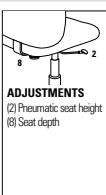
DESCRIPTION	FEATURES	MODEL#	STANDARD TEXTILE GRADES											
			1	2	3	4	5	6	7	8	9	10	11	12
 <p><b>HB Synchro - Tilter w/Back Angle Adjustment</b> COM Yardage: 1 Freight Class: 125 Product Weight (lbs.): 70 Cubic Feet Per Carton: 10.50</p>	 <p><b>ADJUSTMENTS</b> (1) Tilt tension (2) Pneumatic seat height (8) Seat depth (9) Chair tilt lock (5C) Synchro-tilt action Anti-kick back</p>	2220-0	680	707	728	759	803	817	855	927	963	1030	1122	1235
		2220L-0	-	-	-	-	-	-	-	917	963	1023	1122	1235
		<b>OVERALL DIMENSIONS</b>			<b>SEAT DIMENSIONS</b>			<b>BACK DIMENSIONS</b>						
		<b>W</b>	<b>D</b>	<b>H</b>	<b>W</b>	<b>D</b>	<b>H</b>	<b>W</b>	<b>H</b>					
			25	24	42	19	18-20.5	16-20		19	27			
			<b>RTA 2</b>											
 <p><b>HB Multi - Tilter</b> COM Yardage: 1 Freight Class: 125 Product Weight (lbs.): 70 Cubic Feet Per Carton: 10.50</p>	 <p><b>ADJUSTMENTS</b> (1) Tilt tension (2) Pneumatic seat height (7) Forward tilt lock (8) Seat depth (9) Chair tilt lock (5A) Center-tilt action</p>	2220-3	680	707	728	759	803	817	855	927	963	1030	1122	1235
		2220L-3	-	-	-	-	-	-	-	917	963	1023	1122	1235
		<b>OVERALL DIMENSIONS</b>			<b>SEAT DIMENSIONS</b>			<b>BACK DIMENSIONS</b>						
		<b>W</b>	<b>D</b>	<b>H</b>	<b>W</b>	<b>D</b>	<b>H</b>	<b>W</b>	<b>H</b>					
			25	24	42	19	18-20.5	16-20		19	27			
			<b>RTA 2</b>											
 <p><b>HB Tilter</b> COM Yardage: 1 Freight Class: 150 Product Weight (lbs.): 59 Cubic Feet Per Carton: 10.50</p>	 <p><b>ADJUSTMENTS</b> (1) Tilt tension (2) Pneumatic seat height (5A) Center-tilt action</p>	2220-4	582	609	630	662	704	719	758	830	866	933	1024	1138
		2220L-4	-	-	-	-	-	-	-	818	866	924	1025	1138
		<b>OVERALL DIMENSIONS</b>			<b>SEAT DIMENSIONS</b>			<b>BACK DIMENSIONS</b>						
		<b>W</b>	<b>D</b>	<b>H</b>	<b>W</b>	<b>D</b>	<b>H</b>	<b>W</b>	<b>H</b>					
			25	24	42.5	19	18-20.5	16-20		19	27			
			<b>RTA 2</b>											

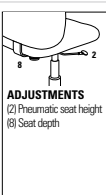
DESCRIPTION	FEATURES	MODEL#	STANDARD TEXTILE GRADES																																																																											
			1	2	3	4	5	6	7	8	9	10	11	12																																																																
 <p><b>HB Weight Sensing Synchro - Tilter</b> COM Yardage: 1 Freight Class: 125 Product Weight (lbs.): 70 Cubic Feet Per Carton: 10.50</p>	 <p><b>ADJUSTMENTS</b> Weight sensing auto tension adjustment (2) Pneumatic seat height (8) Sliding seat depth (9) Multi position tilt lock</p>	<p>Ergonomic Features: A, B, C, E, H, J, M, N, Q</p>	<table border="1"> <tr> <td>2220-8</td> <td>680</td> <td>707</td> <td>728</td> <td>759</td> <td>803</td> <td>817</td> <td>855</td> <td>927</td> <td>963</td> <td>1030</td> <td>1122</td> <td>1235</td> </tr> <tr> <td>2220L-8</td> <td>-</td> <td>-</td> <td>-</td> <td>-</td> <td>-</td> <td>-</td> <td>-</td> <td>917</td> <td>963</td> <td>1023</td> <td>1122</td> <td>1235</td> </tr> <tr> <td colspan="3"><b>OVERALL DIMENSIONS</b></td> <td colspan="3"><b>SEAT DIMENSIONS</b></td> <td colspan="3"><b>BACK DIMENSIONS</b></td> <td colspan="3"></td> </tr> <tr> <td><b>W</b></td> <td><b>D</b></td> <td><b>H</b></td> <td><b>W</b></td> <td><b>D</b></td> <td><b>H</b></td> <td><b>W</b></td> <td><b>H</b></td> <td colspan="2"></td> <td colspan="2"></td> <td></td> </tr> <tr> <td>25</td> <td>24</td> <td>42</td> <td>19</td> <td>18-20.5</td> <td>16-20</td> <td>19</td> <td>27</td> <td colspan="2"></td> <td colspan="2"></td> <td></td> </tr> </table>												2220-8	680	707	728	759	803	817	855	927	963	1030	1122	1235	2220L-8	-	-	-	-	-	-	-	917	963	1023	1122	1235	<b>OVERALL DIMENSIONS</b>			<b>SEAT DIMENSIONS</b>			<b>BACK DIMENSIONS</b>						<b>W</b>	<b>D</b>	<b>H</b>	<b>W</b>	<b>D</b>	<b>H</b>	<b>W</b>	<b>H</b>						25	24	42	19	18-20.5	16-20	19	27					
			2220-8	680	707	728	759	803	817	855	927	963	1030	1122	1235																																																															
			2220L-8	-	-	-	-	-	-	-	917	963	1023	1122	1235																																																															
			<b>OVERALL DIMENSIONS</b>			<b>SEAT DIMENSIONS</b>			<b>BACK DIMENSIONS</b>																																																																					
			<b>W</b>	<b>D</b>	<b>H</b>	<b>W</b>	<b>D</b>	<b>H</b>	<b>W</b>	<b>H</b>																																																																				
25	24	42	19	18-20.5	16-20	19	27																																																																							
 <p><b>MB Synchro - Tilter w/Back Angle Adjustment</b> COM Yardage: 1 Freight Class: 125 Product Weight (lbs.): 68 Cubic Feet Per Carton: 10.50</p>	 <p><b>ADJUSTMENTS</b> (1) Tilt tension (2) Pneumatic seat height (8) Seat depth (9) Chair tilt lock (5C) Synchro-tilt action Anti-kick back</p>	<p>Ergonomic Features: A, B, C, E, H, L, M, N, Q</p>	<table border="1"> <tr> <td>2221-0</td> <td>658</td> <td>683</td> <td>704</td> <td>735</td> <td>778</td> <td>794</td> <td>832</td> <td>904</td> <td>939</td> <td>1007</td> <td>1098</td> <td>1212</td> </tr> <tr> <td>2221L-0</td> <td>-</td> <td>-</td> <td>-</td> <td>-</td> <td>-</td> <td>-</td> <td>-</td> <td>895</td> <td>941</td> <td>1000</td> <td>1101</td> <td>1214</td> </tr> <tr> <td colspan="3"><b>OVERALL DIMENSIONS</b></td> <td colspan="3"><b>SEAT DIMENSIONS</b></td> <td colspan="3"><b>BACK DIMENSIONS</b></td> <td colspan="3"></td> </tr> <tr> <td><b>W</b></td> <td><b>D</b></td> <td><b>H</b></td> <td><b>W</b></td> <td><b>D</b></td> <td><b>H</b></td> <td><b>W</b></td> <td><b>H</b></td> <td colspan="2"></td> <td colspan="2"></td> <td></td> </tr> <tr> <td>25</td> <td>24</td> <td>39</td> <td>19</td> <td>18-20.5</td> <td>16-20</td> <td>19</td> <td>24</td> <td colspan="2"></td> <td colspan="2"></td> <td></td> </tr> </table>												2221-0	658	683	704	735	778	794	832	904	939	1007	1098	1212	2221L-0	-	-	-	-	-	-	-	895	941	1000	1101	1214	<b>OVERALL DIMENSIONS</b>			<b>SEAT DIMENSIONS</b>			<b>BACK DIMENSIONS</b>						<b>W</b>	<b>D</b>	<b>H</b>	<b>W</b>	<b>D</b>	<b>H</b>	<b>W</b>	<b>H</b>						25	24	39	19	18-20.5	16-20	19	24					
			2221-0	658	683	704	735	778	794	832	904	939	1007	1098	1212																																																															
			2221L-0	-	-	-	-	-	-	-	895	941	1000	1101	1214																																																															
			<b>OVERALL DIMENSIONS</b>			<b>SEAT DIMENSIONS</b>			<b>BACK DIMENSIONS</b>																																																																					
			<b>W</b>	<b>D</b>	<b>H</b>	<b>W</b>	<b>D</b>	<b>H</b>	<b>W</b>	<b>H</b>																																																																				
25	24	39	19	18-20.5	16-20	19	24																																																																							
 <p><b>MB Multi - Tilter</b> COM Yardage: 1 Freight Class: 125 Product Weight (lbs.): 68 Cubic Feet Per Carton: 10.50</p>	 <p><b>ADJUSTMENTS</b> (1) Tilt tension (2) Pneumatic seat height (7) Forward tilt lock (8) Seat depth (9) Chair tilt lock (5A) Center-tilt action</p>	<p>Ergonomic Features: A, B, C, E, F, G, H, M, N, Q, S</p>	<table border="1"> <tr> <td>2221-3</td> <td>658</td> <td>683</td> <td>704</td> <td>735</td> <td>778</td> <td>794</td> <td>832</td> <td>904</td> <td>939</td> <td>1007</td> <td>1098</td> <td>1212</td> </tr> <tr> <td>2221L-3</td> <td>-</td> <td>-</td> <td>-</td> <td>-</td> <td>-</td> <td>-</td> <td>-</td> <td>895</td> <td>941</td> <td>1000</td> <td>1101</td> <td>1214</td> </tr> <tr> <td colspan="3"><b>OVERALL DIMENSIONS</b></td> <td colspan="3"><b>SEAT DIMENSIONS</b></td> <td colspan="3"><b>BACK DIMENSIONS</b></td> <td colspan="3"></td> </tr> <tr> <td><b>W</b></td> <td><b>D</b></td> <td><b>H</b></td> <td><b>W</b></td> <td><b>D</b></td> <td><b>H</b></td> <td><b>W</b></td> <td><b>H</b></td> <td colspan="2"></td> <td colspan="2"></td> <td></td> </tr> <tr> <td>25</td> <td>24</td> <td>39</td> <td>19</td> <td>18-20.5</td> <td>16-20</td> <td>19</td> <td>24</td> <td colspan="2"></td> <td colspan="2"></td> <td></td> </tr> </table>												2221-3	658	683	704	735	778	794	832	904	939	1007	1098	1212	2221L-3	-	-	-	-	-	-	-	895	941	1000	1101	1214	<b>OVERALL DIMENSIONS</b>			<b>SEAT DIMENSIONS</b>			<b>BACK DIMENSIONS</b>						<b>W</b>	<b>D</b>	<b>H</b>	<b>W</b>	<b>D</b>	<b>H</b>	<b>W</b>	<b>H</b>						25	24	39	19	18-20.5	16-20	19	24					
			2221-3	658	683	704	735	778	794	832	904	939	1007	1098	1212																																																															
			2221L-3	-	-	-	-	-	-	-	895	941	1000	1101	1214																																																															
			<b>OVERALL DIMENSIONS</b>			<b>SEAT DIMENSIONS</b>			<b>BACK DIMENSIONS</b>																																																																					
			<b>W</b>	<b>D</b>	<b>H</b>	<b>W</b>	<b>D</b>	<b>H</b>	<b>W</b>	<b>H</b>																																																																				
25	24	39	19	18-20.5	16-20	19	24																																																																							
 <p><b>MB Tilter</b> COM Yardage: 1 Freight Class: 150 Product Weight (lbs.): 57 Cubic Feet Per Carton: 10.50</p>	 <p><b>ADJUSTMENTS</b> (1) Tilt tension (2) Pneumatic seat height (5A) Center-tilt action</p>	<p>Ergonomic Features: A, B, C, E, H, M, N, Q, S</p>	<table border="1"> <tr> <td>2221-4</td> <td>561</td> <td>588</td> <td>607</td> <td>639</td> <td>681</td> <td>697</td> <td>735</td> <td>807</td> <td>843</td> <td>909</td> <td>1001</td> <td>1115</td> </tr> <tr> <td>2221L-4</td> <td>-</td> <td>-</td> <td>-</td> <td>-</td> <td>-</td> <td>-</td> <td>-</td> <td>796</td> <td>843</td> <td>902</td> <td>1003</td> <td>1115</td> </tr> <tr> <td colspan="3"><b>OVERALL DIMENSIONS</b></td> <td colspan="3"><b>SEAT DIMENSIONS</b></td> <td colspan="3"><b>BACK DIMENSIONS</b></td> <td colspan="3"></td> </tr> <tr> <td><b>W</b></td> <td><b>D</b></td> <td><b>H</b></td> <td><b>W</b></td> <td><b>D</b></td> <td><b>H</b></td> <td><b>W</b></td> <td><b>H</b></td> <td colspan="2"></td> <td colspan="2"></td> <td></td> </tr> <tr> <td>25</td> <td>24</td> <td>39.5</td> <td>19</td> <td>18-20.5</td> <td>16-20</td> <td>19</td> <td>24</td> <td colspan="2"></td> <td colspan="2"></td> <td></td> </tr> </table>												2221-4	561	588	607	639	681	697	735	807	843	909	1001	1115	2221L-4	-	-	-	-	-	-	-	796	843	902	1003	1115	<b>OVERALL DIMENSIONS</b>			<b>SEAT DIMENSIONS</b>			<b>BACK DIMENSIONS</b>						<b>W</b>	<b>D</b>	<b>H</b>	<b>W</b>	<b>D</b>	<b>H</b>	<b>W</b>	<b>H</b>						25	24	39.5	19	18-20.5	16-20	19	24					
			2221-4	561	588	607	639	681	697	735	807	843	909	1001	1115																																																															
			2221L-4	-	-	-	-	-	-	-	796	843	902	1003	1115																																																															
			<b>OVERALL DIMENSIONS</b>			<b>SEAT DIMENSIONS</b>			<b>BACK DIMENSIONS</b>																																																																					
			<b>W</b>	<b>D</b>	<b>H</b>	<b>W</b>	<b>D</b>	<b>H</b>	<b>W</b>	<b>H</b>																																																																				
25	24	39.5	19	18-20.5	16-20	19	24																																																																							
 <p><b>MB Weight Sensing Synchro - Tilter</b> COM Yardage: 1 Freight Class: 125 Product Weight (lbs.): 68 Cubic Feet Per Carton: 10.50</p>	 <p><b>ADJUSTMENTS</b> Weight sensing auto tension adjustment (2) Pneumatic seat height (8) Sliding seat depth (9) Multi position tilt lock</p>	<p>Ergonomic Features: A, B, C, E, H, J, M, N, Q</p>	<table border="1"> <tr> <td>2221-8</td> <td>658</td> <td>683</td> <td>704</td> <td>735</td> <td>778</td> <td>794</td> <td>832</td> <td>904</td> <td>939</td> <td>1007</td> <td>1098</td> <td>1212</td> </tr> <tr> <td>2221L-8</td> <td>-</td> <td>-</td> <td>-</td> <td>-</td> <td>-</td> <td>-</td> <td>-</td> <td>895</td> <td>941</td> <td>1000</td> <td>1101</td> <td>1214</td> </tr> <tr> <td colspan="3"><b>OVERALL DIMENSIONS</b></td> <td colspan="3"><b>SEAT DIMENSIONS</b></td> <td colspan="3"><b>BACK DIMENSIONS</b></td> <td colspan="3"></td> </tr> <tr> <td><b>W</b></td> <td><b>D</b></td> <td><b>H</b></td> <td><b>W</b></td> <td><b>D</b></td> <td><b>H</b></td> <td><b>W</b></td> <td><b>H</b></td> <td colspan="2"></td> <td colspan="2"></td> <td></td> </tr> <tr> <td>25</td> <td>24</td> <td>39</td> <td>19</td> <td>18-20.5</td> <td>16-20</td> <td>19</td> <td>24</td> <td colspan="2"></td> <td colspan="2"></td> <td></td> </tr> </table>												2221-8	658	683	704	735	778	794	832	904	939	1007	1098	1212	2221L-8	-	-	-	-	-	-	-	895	941	1000	1101	1214	<b>OVERALL DIMENSIONS</b>			<b>SEAT DIMENSIONS</b>			<b>BACK DIMENSIONS</b>						<b>W</b>	<b>D</b>	<b>H</b>	<b>W</b>	<b>D</b>	<b>H</b>	<b>W</b>	<b>H</b>						25	24	39	19	18-20.5	16-20	19	24					
			2221-8	658	683	704	735	778	794	832	904	939	1007	1098	1212																																																															
			2221L-8	-	-	-	-	-	-	-	895	941	1000	1101	1214																																																															
			<b>OVERALL DIMENSIONS</b>			<b>SEAT DIMENSIONS</b>			<b>BACK DIMENSIONS</b>																																																																					
			<b>W</b>	<b>D</b>	<b>H</b>	<b>W</b>	<b>D</b>	<b>H</b>	<b>W</b>	<b>H</b>																																																																				
25	24	39	19	18-20.5	16-20	19	24																																																																							

DESCRIPTION	FEATURES	MODEL#	STANDARD TEXTILE GRADES												
			1	2	3	4	5	6	7	8	9	10	11	12	
 <p><b>MB Task</b> COM Yardage: 1 Freight Class: 150 Product Weight (lbs.): 48 Cubic Feet Per Carton: 10.50</p>	 <p><b>ADJUSTMENTS</b> (2) Pneumatic seat height (8) Seat depth</p>														
		<b>2221-6</b>	561	588	607	639	681	697	735	807	843	909	1001	1115	
		<b>2221L-6</b> Leather	-	-	-	-	-	-	-	-	796	843	902	1003	1115
		<b>OVERALL DIMENSIONS</b>	<b>W D H</b>			<b>SEAT DIMENSIONS</b>			<b>BACK DIMENSIONS</b>						
			25	24	41	19	17.5-18.5	16.5-20.5	19	24					
							<b>RTA 2</b>								
 <p><b>MB Task Armless</b> COM Yardage: 1 Freight Class: 150 Product Weight (lbs.): 42 Cubic Feet Per Carton: 10.50</p>	 <p><b>ADJUSTMENTS</b> (2) Pneumatic seat height (8) Seat depth</p>														
		<b>2222-6</b>	469	497	518	548	592	606	645	717	752	819	910	1025	
		<b>2222L-6</b> Leather	-	-	-	-	-	-	-	705	752	811	912	1025	
		<b>OVERALL DIMENSIONS</b>	<b>W D H</b>			<b>SEAT DIMENSIONS</b>			<b>BACK DIMENSIONS</b>						
			25	24	41	19	17.5-18.5	16.5-20.5	19	24					
							<b>RTA 2</b>								
 <p><b>MB Drafting Stool Task</b> COM Yardage: 1 Freight Class: 150 Product Weight (lbs.): 51 Cubic Feet Per Carton: 10.50</p>	 <p><b>ADJUSTMENTS</b> (2) Pneumatic seat height (8) Seat depth</p>														
		<b>2223-6</b>	877	903	923	954	998	1012	1051	1123	1158	1226	1317	1431	
		<b>2223L-6</b> Leather	-	-	-	-	-	-	-	1107	1154	1213	1314	1428	
		<b>OVERALL DIMENSIONS</b>	<b>W D H</b>			<b>SEAT DIMENSIONS</b>			<b>BACK DIMENSIONS</b>						
			20.5	24.5	48.	19	17.5-18.5	24-34	19	24					
							<b>RTA 2</b>								
 <p><b>MB Drafting Stool Task Armless</b> COM Yardage: 1 Freight Class: 150 Product Weight (lbs.): 45 Cubic Feet Per Carton: 10.50</p>	 <p><b>ADJUSTMENTS</b> (2) Pneumatic seat height (8) Seat depth</p>														
		<b>2224-6</b>	782	809	830	861	904	919	957	1029	1064	1132	1224	1337	
		<b>2224L-6</b> Leather	-	-	-	-	-	-	-	1014	1061	1121	1222	1334	
		<b>OVERALL DIMENSIONS</b>	<b>W D H</b>			<b>SEAT DIMENSIONS</b>			<b>BACK DIMENSIONS</b>						
			19	24	50.5	19	17.5-18.5	24-34	19	24					
							<b>RTA 2</b>								





# multi-purpose

Bakhita .....	134	Islands .....	176	Sidero .....	198
Beach .....	137	Layne .....	177	Sonic .....	202
Beam Seating .....	138	Lite .....	179	Spritz .....	216
Caprice .....	148	Marche .....	183	Spyker .....	219
Chap .....	150	Mayne .....	185	Stream .....	220
Comet .....	152	Moda Four-Legged .....	186	Twilight .....	228
Diplomat .....	155	Moda Stacking .....	187	Vion guest .....	231
Duet .....	156	Popcorn .....	189	Zoma .....	237
File Buddy .....	172	Roma Nester .....	194	Zoocy .....	238
		Sas .....	196		



**BAKHITA**



model 6750



model 6753





model 6754







model 6755

**STANDARD FEATURES**

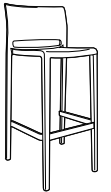
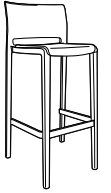
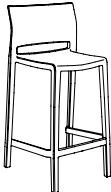
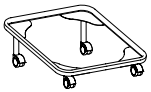
- A comfortable, high-quality, lightweight, stacking chair that is incredibly strong and durable.
- Bakhita is an all polymer chair intended for use indoors or outdoors. Weather resistant, UV and stain resistant, with a modern design.
- Standard height models (6750, 6751) are suitable for use in MRI rooms.
- Chairs are simultaneously molded with two different materials. Inside is a structural fiberglass frame for strength. Outside is a durable polypropylene light fast compound.
- Armchairs and Armless Chairs are finished with a smooth surface. Bar Stools and Counter Stools are finished with a slightly textured surface.
- Upholstered seats will only fit on a frame made for this purpose, it is not possible to add an upholstered seat onto an existing all plastic chair in the field.
- Upholstered seats are fixed and non-removable.
- Chair legs are equipped with translucent non-marking glides as standard. Suitable for outdoor environments, carpet and hard surface flooring.
- Upholstery options: fabric, vinyl, or leather
- For outdoor use Global recommends marine grade vinyls or Sunbrella fabrics with UV resistance.
- Chairs are available in 4 plastic colors: Alloy (**ALY**), Char (**CHA**), Sandbar (**SAN**) and Milk (**MLK**).
- Un-upholstered chairs and stools are available for special order in 4 additional plastic colors: Black (**BLK**), Saffron (**SAF**), Sky (**SKY**) and Turtledove (**TUR**). Must be ordered in multiples of 4, with minimum order quantity of 24 chairs. Average lead time is 16 weeks.
- Custom finishes are available on un-upholstered chairs and stools with a minimum order quantity of 300 chairs. Must be ordered in multiples of 4. Contact Customer Care for details and lead time.
- Armless Counter stool model 6757 is a special order model. Must be ordered in multiples of 4, with minimum order quantity of 24 chairs. Average lead time is 16 weeks.
- Tables are available in standard or bar height and are suitable for outdoor use.
- Tables are available with a Silver base and Milk (**MLK**) top only.
- Table Tops are constructed from technopolymer compounds with high structural, heat and abrasion resistance. Tops are UV, shock and stain resistant.

DESCRIPTION	FEATURES	MODEL#	STANDARD TEXTILE GRADES														
 <p><b>Armchair Poly Seat &amp; Back</b> COM Yardage: N/A Freight Class: 150 Product Weight (lbs.): 14.25 Cubic Feet Per Carton: 13.50 (4 per carton)</p>	<p>Stacks 8 high on floor. Stacks 10 high on dolly.</p>	<p><b>6750</b></p>	1	2	3	4	5	6	7	8	9	10	11	12			
			220														
			<b>OVERALL DIMENSIONS</b>			<b>SEAT DIMENSIONS</b>			<b>BACK DIMENSIONS</b>								
			<b>W</b>	<b>D</b>	<b>H</b>	<b>W</b>	<b>D</b>	<b>H</b>	<b>W</b>	<b>H</b>							
			22.5	21	31.5	16	16	17.25	17	14.5							
		<b>RTA 00</b>	4 per carton (pricing and specifications are for one chair)														
 <p><b>Armless Chair Poly Seat &amp; Back</b> COM Yardage: N/A Freight Class: 150 Product Weight (lbs.): 13 Cubic Feet Per Carton: 11.50 (4 per carton)</p>	<p>Stacks 8 high on floor. Stacks 12 high on dolly.</p>	<p><b>6751</b></p>	1	2	3	4	5	6	7	8	9	10	11	12			
			195														
			<b>OVERALL DIMENSIONS</b>			<b>SEAT DIMENSIONS</b>			<b>BACK DIMENSIONS</b>								
			<b>W</b>	<b>D</b>	<b>H</b>	<b>W</b>	<b>D</b>	<b>H</b>	<b>W</b>	<b>H</b>							
			18	21	31.5	16	16	17.25	17	14.5							
		<b>RTA 00</b>	4 per carton (pricing and specifications are for one chair)														
 <p><b>Armchair Uph Seat &amp; Poly Back</b> COM Yardage: 0.75 Freight Class: 250 Product Weight (lbs.): 16 Cubic Feet Per Carton: 13.50 (3 per carton)</p>	<p>Stacks 8 high on floor. Stacks 10 high on dolly.</p>	<p><b>6752</b></p>	1	2	3	4	5	6	7	8	9	10	11	12			
			366 385 399 421 452 466 495 539 573 611 691 774														
			<b>OVERALL DIMENSIONS</b>			<b>SEAT DIMENSIONS</b>			<b>BACK DIMENSIONS</b>								
			<b>W</b>	<b>D</b>	<b>H</b>	<b>W</b>	<b>D</b>	<b>H</b>	<b>W</b>	<b>H</b>							
			22.5	21	31.5	16	16	18	17	14.5							
		<b>RTA 00</b>	3 per carton (pricing and specifications are for one chair)														

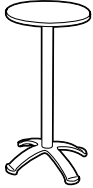
DESCRIPTION	FEATURES	MODEL#	STANDARD TEXTILE GRADES											
			1	2	3	4	5	6	7	8	9	10	11	12
 <p><b>Armless Chair Uph Seat &amp; Poly Back</b> COM Yardage: .75 Freight Class: 250 Product Weight (lbs.): 14.67 Cubic Feet Per Carton: 11.50 (3 per carton)</p>	Stacks 8 high on floor. Stacks 12 high on dolly	6753	335	354	368	390	421	435	464	508	542	580	660	743
			<b>OVERALL DIMENSIONS</b>			<b>SEAT DIMENSIONS</b>			<b>BACK DIMENSIONS</b>					
			W	D	H	W	D	H	W	H				
			18	21	31.5	16	16	18	17	14.5				
			<div style="display: flex; align-items: center;"> <div style="background-color: black; color: white; padding: 2px 5px; margin-right: 5px;">RTA 00</div> <span>3 per carton (pricing and specifications are for one chair)</span> </div>											
 <p><b>Armless Bar Stool Poly Seat &amp; Back</b> COM Yardage: .75 Freight Class: 150 Product Weight (lbs.): 15 Cubic Feet Per Carton: 12.75 (4 per carton)</p>	Stacks 4 high on floor.	6754	295											
			<b>OVERALL DIMENSIONS</b>			<b>SEAT DIMENSIONS</b>			<b>BACK DIMENSIONS</b>					
			W	D	H	W	D	H	W	H				
			19.25	18.75	40.5	14	15	30	17	10.5				
			<div style="display: flex; align-items: center;"> <div style="background-color: black; color: white; padding: 2px 5px; margin-right: 5px;">RTA 00</div> <span>4 per carton (pricing and specifications are for one chair)</span> </div>											
 <p><b>Armless Bar Stool Uph Seat &amp; Poly Back</b> COM Yardage: .75 Freight Class: 250 Product Weight (lbs.): 16.67 Cubic Feet Per Carton: 12.75 (3 per carton)</p>	Stacks 4 high on floor.	6755	454	472	488	509	541	556	585	630	665	704	784	870
			<b>OVERALL DIMENSIONS</b>			<b>SEAT DIMENSIONS</b>			<b>BACK DIMENSIONS</b>					
			W	D	H	W	D	H	W	H				
			19	18	40	14	15	30.75	17	10.5				
			<div style="display: flex; align-items: center;"> <div style="background-color: black; color: white; padding: 2px 5px; margin-right: 5px;">RTA 00</div> <span>3 per carton (pricing and specifications are for one chair)</span> </div>											
 <p><b>Armless Counter Stool Poly Seat &amp; Back</b> COM Yardage: 0 Freight Class: 150 Product Weight (lbs.): 15 Cubic Feet Per Carton: 12.75 (4 per carton)</p>	Stacks 4 high on floor.	6757	295											
			<b>OVERALL DIMENSIONS</b>			<b>SEAT DIMENSIONS</b>			<b>BACK DIMENSIONS</b>					
			W	D	H	W	D	H	W	H				
			19	18.5	34.25	14	15	26	17	10.5				
			<div style="display: flex; align-items: center;"> <div style="background-color: black; color: white; padding: 2px 5px; margin-right: 5px;">RTA 00</div> <span>4 per carton (pricing and specifications are for one chair)</span> </div> <p style="text-align: center; margin-top: 5px;">**Special order only</p>											
 <p><b>Chair Dolly</b> COM Yardage: N/A Freight Class: 150 Product Weight (lbs.): 16 Cubic Feet Per Carton: 2.90</p>		6783	260											
			<b>OVERALL DIMENSIONS</b>			<b>SEAT DIMENSIONS</b>			<b>BACK DIMENSIONS</b>					
			W	D	H	W	D	H	W	H				
			19.75	23.25	9.75	-	-	-	-	-				
			<div style="display: flex; align-items: center;"> <div style="background-color: black; color: white; padding: 2px 5px; margin-right: 5px;">RTA 00</div> <div style="margin-right: 5px;"></div> <span>1 per carton</span> </div>											

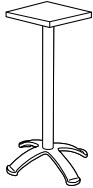
DESCRIPTION	FEATURES	MODEL#	STANDARD TEXTILE GRADES												
			1	2	3	4	5	6	7	8	9	10	11	12	
 <p><b>Round Table - Café Height</b> COM Yardage: N/A Freight Class: 100 Product Weight (lbs.): 40 Cubic Feet Per Carton: 1 (3 cartons per one model)</p>		<b>6780</b>	425												
 <p><b>Round Table - Bar Height</b> COM Yardage: N/A Freight Class: 100 Product Weight (lbs.): 41 Cubic Feet Per Carton: 1 (3 cartons per one model)</p>		<b>6781</b>	435												
 <p><b>Square Table - Café Height</b> COM Yardage: N/A Freight Class: 100 Product Weight (lbs.): 42.5 Cubic Feet Per Carton: 1 (3 cartons per one model)</p>		<b>6785</b>	465												
 <p><b>Square Table - Bar Height</b> COM Yardage: N/A Freight Class: 100 Product Weight (lbs.): 43.5 Cubic Feet Per Carton: 1 (3 cartons per one model)</p>		<b>6786</b>	475												

BEACH™



model 4077



model 4078

STANDARD FEATURES

- Elegant wood seating with a choice of an upholstered or vertical wood slat back.
- Frame construction is beech hardwood.
- Furniture legs are equipped with white non marking polypropylene glides as standard. Suitable for both carpet and hard surface flooring.
- All cushions are fixed and non-removable.
- Cushions are highly resilient foam and seats are equipped with a synthetic rubberized webbing suspension system for extra comfort.
- For coordinating occasional tables see Dawson wood tables.

OPTIONAL FEATURES

- Frame available in Absolute (AAM), Black (BKM), Cherry (ACM), Espresso Cafe (ECM), English Oak (EOM), Fruitwood (TFM), Gray (HGM), Honey (AHM), Mahogany (TMM), Maple (AVM), Medium Walnut (MWM), Night (ASM), Shaker Cherry (SKM), Walnut (TWM), WC Cream (WTM), White (WHM) and Winter Cherry (WCM). Please Specify.
- Offered in Fabric, Vinyl, Leather and Leather/ Mock Leather.

DESCRIPTION	FEATURES	MODEL#	STANDARD TEXTILE GRADES											
-------------	----------	--------	-------------------------	--	--	--	--	--	--	--	--	--	--	--



**Armchair w/Upholstered back.**  
 COM Yardage: 1.50  
 Freight Class: 300  
 Product Weight (lbs.): 20  
 Cubic Feet Per Carton: 11.75

Does not stack.

	1	2	3	4	5	6	7	8	9	10	11	12
4077	657	683	704	734	777	798	837	900	947	1001	1111	1228

OVERALL DIMENSIONS			SEAT DIMENSIONS			BACK DIMENSIONS	
W	D	H	W	D	H	W	H
22	23	33.5	19.5	18.5	18.75	19.5	15.5

RTA 00



**Armchair w/Vertical Wood Slat back.**  
 COM Yardage: 1.00  
 Freight Class: 300  
 Product Weight (lbs.): 20  
 Cubic Feet Per Carton: 11.75

Does not stack.

	1	2	3	4	5	6	7	8	9	10	11	12
4078	689	715	737	769	814	836	877	942	992	1049	1164	1287

OVERALL DIMENSIONS			SEAT DIMENSIONS			BACK DIMENSIONS	
W	D	H	W	D	H	W	H
22	23	33.5	19.5	18.5	18.75	19.5	15.5

RTA 00

**BEAM SEATING**



\*see sample layout SON507 for models included above.

**STANDARD FEATURES**

- The universal beam units and tables listed are shown here, along with beam seating upper components from several seating lines.
- Beams are standard in Black. The “T” shaped legs are available in Chrome only with Black anti scuff tips and trim.
- Corner beam creates 90° turn in beam seating. Only table units can be attached.
- Beams and legs are shipped fully assembled.
- Upper seating units include mounting brackets and all necessary hardware for attachment to beam.
- Upper seating units and/or tables can be placed in any order along the beam.
- Power monument has two AC outlets, dual 2.1 amp USB ports.
- **Specifications and pricing are for 1 chair.**

**OPTIONAL FEATURES**

- Upholstery options: fabric or vinyl. Sidero Exceptions: Jenny, Match, Quilt, and Couture. Vion Exceptions: Jenny..
- Optional universal aluminum arm with soft pad available for mounting on beam in multiple positions, model 6500A8. 112 list.
- Sonic seating units are available in mesh back, Black only.
- Vion seating units available in 10 mesh colors: Black (MS69), Stone (MS71), Blue (MS72), Rope (MS73), Natural (MS74), Aqua (MS75), Black Cherry (MS76), Dust (MS77), Ivory (MS78) and Paprika (MS79). Please specify. No upcharge.

**OPTIONAL FEATURES (continued)**

- Vion is available with a Black (BLK) Back Frame as standard or an optional Fog (FOG) Back Frame, please add \$53 list.
- Duet, Popcorn and Sonic seating units are available in 14 designer colors. Choose from Buzz Blue (BZB), Cactus (CCT), Carrot (CRO), Cloud (IVC), Dijon (DJN), Eggplant (EGP), Fog (FOG), Frost (FRO), Ink (INK), Latte (LAB), Night (BLK), Sand (SND), Scarlet (SAR), and Shadow (SHW).
- Duet arms will match the specified polypropylene color.
- Sidero, Sonic and Vion arm models are standard in Black only.
- Duet, Popcorn and Sonic are standard in a Chrome (CH) frame finish. Sidero and Vion are standard in Black (BK) frame finish.
- Beam seating laminate table tops are available in Absolute Acajou (ACJ), Asian Night (ASN), Avant Cherry (AWC), Avant Honey (AWH), Brushed Cobalt (BRC), Clear Maple (CMB), Dark Espresso (DES), Designer White (DWT), Hayden Grey (HGT), Tiger Walnut (TWL), Walnut Heights (WHE), Winter Cherry (WCR), White Chocolate (WHC). Please specify. No upcharge.

**SAMPLE LAYOUTS**

**VON501 - Shown**



Approximate dimensions: 74”W x 24”D

Kit Layout	Description	Total (Grd. 1)
<b>VON501</b>	<b>Vion armless seat units with Beam components:</b> 6340 (3 seats), 6500S3 (1 beam)	<b>2453</b>
DUT501	Duet armless seat units with Beam components: 6691 (3 seats), 6500S3 (1 beam)	1259
POP501	Popcorn armless seat units with Beam components: 6717 (3 seats), 6500S3 (1 beam)	1346
SID501	Sidero armless seat units with Beam components: 6931 (3 seats), 6500S3 (1 beam)	2009
SON501	Sonic armless seat units with Beam components: 6501 (3 seats), 6500S3 (1 beam)	1508

\*See next pages for individual model description, dimensions and starting list price.

**SON502 - Shown**



Approximate dimensions: 100”W x 24”D

Kit Layout	Description	Total (Grd. 1)
<b>SON502</b>	<b>Sonic arm seat units with Beam components:</b> 6506 (4 seats), 6500S4 (1 beam)	<b>2517</b>
DUT502	Duet arm seat units with Beam components: 6690 (4 seats), 6500S4 (1 beam)	2033
POP502	Popcorn armless seat units with Universal arms and Beam components: 6717 (4 seats), 6500S4 (1 beam), and 6500A8 (5 arms)	2393
SID502	Sidero arm seat units with Beam components: 6930 (4 seats), 6500S4 (1 beam)	2893
VON502	Vion arm seat units with Beam components: 6342 (4 seats), 6500S4 (1 beam)	3129

\*See next pages for individual model description, dimensions and starting list price.

**SAMPLE LAYOUTS**

**DUT503 - Shown**



Approximate dimensions: 100"W x 24"D

Kit Layout	Description	Total (Grd. 1)
<b>DUT503</b>	<b>Duet armless seat units with Beam components:</b> 6691 (3 seats), 6500S4 (1 beam), 6507 (1 table)	<b>1735</b>
POP503	Popcorn armless seat units with Beam components: 6717 (3 seats), 6500S4 (1 beam), 6507 (1 table)	1822
SID503	Sidero armless seat units with Beam components: 6931 (3 seats), 6500S4 (1 beam), 6507 (1 table)	2485
SON503	Sonic armless seat units with Beam components: 6501 (3 seats), 6500S4 (1 beam), 6507 (1 table)	1984
VON503	Vion armless seat units with Beam components: 6340 (3 seats), 6500S4 (1 beam), 6507 (1 table)	2929

\*See next pages for individual model description, dimensions and starting list price.

**POP504 - Shown**



Approximate dimensions: 122"W x 24"D

Kit Layout	Description	Total (Grd. 1)
<b>POP504</b>	<b>Popcorn seat units with Universal arms and Beam components:</b> 6717 (4 seats), 6500A8 (6 arms), 6500S3 (1 beam), 6500A2 (1 beam), 6507 (1 table), 6591B (1 Module)	<b>3323</b>
DUT504	Duet arm seat units with Beam components: 6690 (4 seats), 6500S3 (1 beam), 6500A2 (1 beam), 6507 (1 table), 6591B (1 Module)	2851
SID504	Sidero arm seat units with Beam components: 6930 (4 seats), 6500S3 (1 beam), 6500A2 (1 beam), 6507 (1 table), 6591B (1 Module)	3711
SON504	Sonic arm seat units with Beam components: 6504 (4 seats), 6500S3 (1 beam), 6500A2 (1 beam), 6507 (1 table), 6591B (1 Module)	3075
VON504	Vion arm seat units with Beam components: 6342 (4 seats), 6500S3 (1 beam), 6500A2 (1 beam), 6507 (1 table), 6591B (1 Module)	3947

\*See next pages for individual model description, dimensions and starting list price.

**SID505 - Shown**



Approximate dimensions: 147"W x 24"D

Kit Layout	Description	Total (Grd. 1)
<b>SID505</b>	<b>Sidero armless seat units with Beam components:</b> 6931 (4 seats), 6500S3 (1 beam), 6500A3 (1 beam), 6507 (2 table)	<b>3351</b>
DUT505	Duet armless seat units with Beam components: 6691 (4 seats), 6500S3 (1 beam), 6500A3 (1 beam), 6507 (2 table)	2451
POP505	Popcorn armless seat units with Beam components: 6717 (4 seats), 6500S3 (1 beam), 6500A3 (1 beam), 6507 (2 table)	2567
SON505	Sonic armless seat units with Beam components: 6501 (4 seats), 6500S3 (1 beam), 6500A3 (1 beam), 6507 (2 table)	2783
VON505	Vion armless seat units with Beam components: 6340 (4 seats), 6500S3 (1 beam), 6500A3 (1 beam), 6507 (2 table)	4043

\*See next pages for individual model description, dimensions and starting list price.

**VON506 - Shown**



Approximate dimensions: 103"W x 103"D

Kit Layout	Description	Total (Grd. 1)
<b>VON506</b>	<b>Vion arm seat units with Beam components:</b> 6342 (6 seats), 6500S3 (2 beams), 6507-T2 (1 table), 6500A9 (1 Connector)	<b>5163</b>
DUT504	Duet arm seat units with Beam components: 6690 (6 seats), 6500S3 (2 beams), 6507-T2 (1 table), 6500A9 (1 Connector)	3519
POP505	Popcorn armless seat units with Universal arms and Beam components: 6717 (6 seats), 6500A8 (8 arms), 6500S3 (2 beams), 6507-T2 (1 table), 6500A9 (1 Connector)	4115
SID504	Sidero arm seat units with Beam components: 6930 (6 seats), 6500S3 (2 beams), 6507-T2 (1 table), 6500A9 (1 Connector)	4809
SON504	Sonic arm seat units with Beam components: 6504 (6 seats), 6500S3 (2 beams), 6507-T2 (1 table), 6500A9 (1 Connector)	3855

\*See next pages for individual model description, dimensions and starting list price.

**SAMPLE LAYOUTS**

**SON507 - Shown**



Approximate dimensions: 103"W x 103"D

Kit Layout	Description	Total (Grd. 1)
<b>SON507</b>	<b>Sonic arm seat units with Beam components:</b> 6506 (6 seats), 6500S3 (2 beams), 6507-T2 (1 table), 6500A9 (1 connector)	<b>4245</b>
DUT507	Duet arm seat units with Beam components: 6690 (6 seats), 6500S3 (2 beams), 6507-T2 (1 table), 6500A9 (1 connector)	3519
POP507	Popcorn armless seat units with Universal arms and Beam components: 6717 (6 seats), 6500S3 (2 beams), 6507-T2 (1 table), 6500A9 (1 connector) and 6500A8 (8 arms)	4115
SID507	Sidero arm seat units with Beam components: 6930 (6 seats), 6500S3 (2 beams), 6507-T2 (1 table), 6500A9 (1 connector)	4809
VON507	Vion arm seat units with Beam components: 6342 (6 seats), 6500S3 (2 beams), 6507-T2 (1 table), 6500A9 (1 connector)	5163

\*See next pages for individual model description, dimensions and starting list price.

**DUT508 - Shown**



Approximate dimensions: 131"W x 78"D

Kit Layout	Description	Total (Grd. 1)
<b>DUT508</b>	<b>Duet armless seat units with Beam components:</b> 6691 (7 seats), 6500S3 (1 Beam), 6500S2 (2 Beams), 6507-T2 (2 Tables), 6500A9 (2 Connector), 6591B (2 Modules)	<b>5077</b>
POP508	Popcorn armless seat units with Beam components: 6717 (7 seats), 6500S3 (1 Beam), 6500S2 (2 Beams), 6507-T2 (2 Tables), 6500A9 (2 Connector), 6591B (2 Modules)	5280
SID508	Sidero armless seat units with Beam components: 6931 (7 seats), 6500S3 (1 Beam), 6500S2 (2 Beams), 6507-T2 (2 Tables), 6500A9 (2 Connector), 6591B (2 Modules)	6827
SON508	Sonic armless seat units with Beam components: 6501 (7 seats), 6500S3 (1 Beam), 6500S2 (2 Beams), 6507-T2 (2 Tables), 6500A9 (2 Connector), 6591B (2 Modules)	5658
VON507	Vion armless seat units with Beam components: 6340 (7 seats), 6500S3 (1 Beam), 6500S2 (2 Beams), 6507-T2 (2 Tables), 6500A9 (2 Connector), 6591B (2 Modules)	7863

\*See next pages for individual model description, dimensions and starting list price.

DESCRIPTION	FEATURES	MODEL#	STANDARD TEXTILE GRADES											
			1	2	3	4	5	6	7	8	9	10	11	12

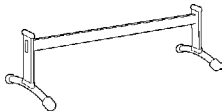

**Beam - Accommodates 2 Seats**  
COM Yardage: N/A  
Freight Class: 250  
Product Weight (lbs.): 37  
Cubic Feet Per Carton: 11 (1 per carton)

Freestanding

<b>6500S2</b>	524	-	-	-	-	-	-	-	-	-	-	-	-
---------------	-----	---	---	---	---	---	---	---	---	---	---	---	---

OVERALL DIMENSIONS			SEAT DIMENSIONS			BACK DIMENSIONS	
W	D	H	W	D	H	W	H

49.5	24	16	-	-	-	-	-
------	----	----	---	---	---	---	---

RTA 00

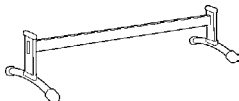

**Beam - Accommodates 3 Seats**  
COM Yardage: N/A  
Freight Class: 250  
Product Weight (lbs.): 43  
Cubic Feet Per Carton: 16 (1 per carton)





Freestanding

<b>6500S3</b>	605	-	-	-	-	-	-	-	-	-	-	-	-
---------------	-----	---	---	---	---	---	---	---	---	---	---	---	---



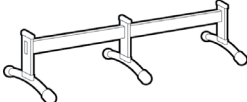



OVERALL DIMENSIONS			SEAT DIMENSIONS			BACK DIMENSIONS	
W	D	H	W	D	H	W	H



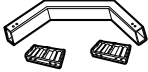





74	24	16	-	-	-	-	-
----	----	----	---	---	---	---	---













RTA 00









DESCRIPTION	FEATURES	MODEL#	STANDARD TEXTILE GRADES													
			1	2	3	4	5	6	7	8	9	10	11	12		
 <p><b>Beam - Accommodates 4 Seats</b>                      COM Yardage: N/A                      Freight Class: 250                      Product Weight (lbs.): 58                      Cubic Feet Per Carton: 22 (1 per carton)</p>	Freestanding	6500S4	845	-	-	-	-	-	-	-	-	-	-	-		
			<b>OVERALL DIMENSIONS</b>			<b>SEAT DIMENSIONS</b>			<b>BACK DIMENSIONS</b>							
			<b>W</b>	<b>D</b>	<b>H</b>	<b>W</b>	<b>D</b>	<b>H</b>	<b>W</b>	<b>H</b>						
			100	24	16	-	-	-	-	-						
			<b>RTA 00</b>													
 <p><b>Beam Extender - Accommodates 2 Seats</b>                      COM Yardage: N/A                      Freight Class: 85                      Product Weight (lbs.): 36                      Cubic Feet Per Carton: 10.5 (1 per carton)</p>	Not Freestanding. Includes hardware.	6500A2	400	-	-	-	-	-	-	-	-	-	-	-		
			<b>OVERALL DIMENSIONS</b>			<b>SEAT DIMENSIONS</b>			<b>BACK DIMENSIONS</b>							
			<b>W</b>	<b>D</b>	<b>H</b>	<b>W</b>	<b>D</b>	<b>H</b>	<b>W</b>	<b>H</b>						
			47.5	24	16	-	-	-	-	-						
			<b>RTA 00</b>													
 <p><b>Beam Extender - Accommodates 3 Seats</b>                      COM Yardage: N/A                      Freight Class: 85                      Product Weight (lbs.): 43                      Cubic Feet Per Carton: 16 (1 per carton)</p>	Not Freestanding. Includes hardware.	6500A3	502	-	-	-	-	-	-	-	-	-	-	-		
			<b>OVERALL DIMENSIONS</b>			<b>SEAT DIMENSIONS</b>			<b>BACK DIMENSIONS</b>							
			<b>W</b>	<b>D</b>	<b>H</b>	<b>W</b>	<b>D</b>	<b>H</b>	<b>W</b>	<b>H</b>						
			72	24	16	-	-	-	-	-						
			<b>RTA 00</b>													
 <p><b>Beam Extender - Accommodates 4 Seats</b>                      COM Yardage: N/A                      Freight Class: 85                      Product Weight (lbs.): 58                      Cubic Feet Per Carton: 21.75 (1 per carton)</p>	Not Freestanding. Includes hardware.	6500A4	754	-	-	-	-	-	-	-	-	-	-	-		
			<b>OVERALL DIMENSIONS</b>			<b>SEAT DIMENSIONS</b>			<b>BACK DIMENSIONS</b>							
			<b>W</b>	<b>D</b>	<b>H</b>	<b>W</b>	<b>D</b>	<b>H</b>	<b>W</b>	<b>H</b>						
			98	24	16	-	-	-	-	-						
			<b>RTA 00</b>													
 <p><b>Universal Aluminum Arm w/Pad</b>                      COM Yardage: N/A                      Freight Class: 85                      Product Weight (lbs.): 3.5                      Cubic Feet Per Carton: 0.5 (1 per carton)</p>	Includes hardware.	6500A8	112	-	-	-	-	-	-	-	-	-	-	-		
			<b>OVERALL DIMENSIONS</b>			<b>SEAT DIMENSIONS</b>			<b>BACK DIMENSIONS</b>							
			<b>W</b>	<b>D</b>	<b>H</b>	<b>W</b>	<b>D</b>	<b>H</b>	<b>W</b>	<b>H</b>						
			2.5	10	14	-	-	-	-	-						
			<b>RTA 00</b>													



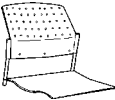







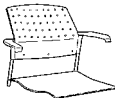

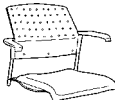
DESCRIPTION	FEATURES	MODEL#	STANDARD TEXTILE GRADES													
			1	2	3	4	5	6	7	8	9	10	11	12		
 <p><b>Corner Connector Beam</b> COM Yardage: N/A Freight Class: 85 Product Weight (lbs.): 9 Cubic Feet Per Carton: 0.07 (1 per carton)</p>	<p>Not Freestanding. Includes hardware.</p>	6500A9	219	-	-	-	-	-	-	-	-	-	-	-		
			<b>OVERALL DIMENSIONS</b>			<b>SEAT DIMENSIONS</b>			<b>BACK DIMENSIONS</b>							
			<b>W</b>	<b>D</b>	<b>H</b>	<b>W</b>	<b>D</b>	<b>H</b>	<b>W</b>	<b>H</b>						
			1.75	24	3.25	-	-	-	-	-						
			<b>RTA 00</b>													
 <p><b>Bolt Down Kit</b> COM Yardage: N/A Freight Class: 85 Product Weight (lbs.): 8 Cubic Feet Per Carton: .60 (1 per carton)</p>	<p>Set of 4 brackets. Includes hardware.</p>	6500BD	102	-	-	-	-	-	-	-	-	-	-	-		
			<b>OVERALL DIMENSIONS</b>			<b>SEAT DIMENSIONS</b>			<b>BACK DIMENSIONS</b>							
			<b>W</b>	<b>D</b>	<b>H</b>	<b>W</b>	<b>D</b>	<b>H</b>	<b>W</b>	<b>H</b>						
			17.75	17.75	1	-	-	-	-	-						
			<b>RTA 00</b> 													
 <p><b>Power Module</b> COM Yardage: N/A Freight Class: 85 Product Weight (lbs.): 3.2 Cubic Feet Per Carton: 0.5 (1 per carton)</p>	<p>Under mount, 10 ft. cord. Black only.</p>	6591B	422	-	-	-	-	-	-	-	-	-	-	-		
			<b>OVERALL DIMENSIONS</b>			<b>SEAT DIMENSIONS</b>			<b>BACK DIMENSIONS</b>							
			<b>W</b>	<b>D</b>	<b>H</b>	<b>W</b>	<b>D</b>	<b>H</b>	<b>W</b>	<b>H</b>						
			21	21	1	-	-	-	-	-						
			<b>RTA 00</b>													
 <p><b>End Table Top</b> COM Yardage: N/A Freight Class: 85 Product Weight (lbs.): 8 Cubic Feet Per Carton: .60 (1 per carton)</p>	<p>Includes hardware. Use on beams.</p>	6507	236	-	-	-	-	-	-	-	-	-	-	-		
			<b>OVERALL DIMENSIONS</b>			<b>SEAT DIMENSIONS</b>			<b>BACK DIMENSIONS</b>							
			<b>W</b>	<b>D</b>	<b>H</b>	<b>W</b>	<b>D</b>	<b>H</b>	<b>W</b>	<b>H</b>						
			17.75	17.75	1	-	-	-	-	-						
			<b>RTA 00</b> 													
 <p><b>Square Corner Table Top</b> COM Yardage: N/A Freight Class: 85 Product Weight (lbs.): 14 Cubic Feet Per Carton: 1.9 (1 per carton)</p>	<p>Includes hardware. Use on beams.</p>	6507-T1	280	-	-	-	-	-	-	-	-	-	-	-		
			<b>OVERALL DIMENSIONS</b>			<b>SEAT DIMENSIONS</b>			<b>BACK DIMENSIONS</b>							
			<b>W</b>	<b>D</b>	<b>H</b>	<b>W</b>	<b>D</b>	<b>H</b>	<b>W</b>	<b>H</b>						
			21	21	1	-	-	-	-	-						
			<b>RTA 00</b>													

DESCRIPTION	FEATURES	MODEL#	STANDARD TEXTILE GRADES											
			1	2	3	4	5	6	7	8	9	10	11	12
 <p><b>Radius Corner Table Top</b> COM Yardage: N/A Freight Class: 85 Product Weight (lbs.): 14 Cubic Feet Per Carton: 1.9 (1 per carton)</p>	Includes hardware. Use on beams.	6507-T2	308	-	-	-	-	-	-	-	-	-	-	-
			<b>OVERALL DIMENSIONS</b>			<b>SEAT DIMENSIONS</b>			<b>BACK DIMENSIONS</b>					
			<b>W</b>	<b>D</b>	<b>H</b>	<b>W</b>	<b>D</b>	<b>H</b>	<b>W</b>	<b>H</b>				
			21	21	1	-	-	-	-	-				
			<b>RTA 00</b>											
 <p><b>Coffee Table</b> COM Yardage: N/A Freight Class: 85 Product Weight (lbs.): 52 Cubic Feet Per Carton: 12.25 (1 per carton)</p>		6507-CT	683	-	-	-	-	-	-	-	-	-	-	
			<b>OVERALL DIMENSIONS</b>			<b>SEAT DIMENSIONS</b>			<b>BACK DIMENSIONS</b>					
			<b>W</b>	<b>D</b>	<b>H</b>	<b>W</b>	<b>D</b>	<b>H</b>	<b>W</b>	<b>H</b>				
			24	42	17.5	-	-	-	-	-				
			<b>RTA 00</b>											
 <p><b>Seat Unit w/Arms</b> COM Yardage: N/A Freight Class: 250 Product Weight (lbs.): 19 Cubic Feet Per Carton: 4.88 (2 per carton)</p>	<b>Duet</b> Use with beams.	6690	297	-	-	-	-	-	-	-	-	-	-	
			<b>OVERALL DIMENSIONS</b>			<b>SEAT DIMENSIONS</b>			<b>BACK DIMENSIONS</b>					
			<b>W</b>	<b>D</b>	<b>H</b>	<b>W</b>	<b>D</b>	<b>H</b>	<b>W</b>	<b>H</b>				
			25.5	21	18	18	17.5	-	18	16				
			<b>RTA 00</b>											
 <p><b>Armless Seat Unit</b> COM Yardage: N/A Freight Class: 150 Product Weight (lbs.): 18 Cubic Feet Per Carton: 3.25 (2 per carton)</p>	<b>Duet</b> Use with beams.	6691	218	-	-	-	-	-	-	-	-	-	-	
			<b>OVERALL DIMENSIONS</b>			<b>SEAT DIMENSIONS</b>			<b>BACK DIMENSIONS</b>					
			<b>W</b>	<b>D</b>	<b>H</b>	<b>W</b>	<b>D</b>	<b>H</b>	<b>W</b>	<b>H</b>				
			18	21	18	18	17.5	-	18	16				
			<b>RTA 00</b>											
 <p><b>Seat Unit w/Arms</b> COM Yardage: 1 Freight Class: 250 Product Weight (lbs.): 19 Cubic Feet Per Carton: 4.88 (2 per carton)</p>	<b>Duet</b> Upholstered Seat. Use with beams.	6692	363	390	410	441	485	499	538	609	645	713	804	918
			<b>OVERALL DIMENSIONS</b>			<b>SEAT DIMENSIONS</b>			<b>BACK DIMENSIONS</b>					
			<b>W</b>	<b>D</b>	<b>H</b>	<b>W</b>	<b>D</b>	<b>H</b>	<b>W</b>	<b>H</b>				
			25.5	21	18	18	17.5	-	18	16				
			<b>RTA 00</b>											

DESCRIPTION	FEATURES	MODEL#	STANDARD TEXTILE GRADES											
			1	2	3	4	5	6	7	8	9	10	11	12
  <b>Armless Seat Unit</b> COM Yardage: 1 Freight Class: 150 Product Weight (lbs.): 19 Cubic Feet Per Carton: 3.25 (2 per carton)	<b>Duet</b> Upholstered Seat. Use with beams.	<b>6693</b>	282	307	327	359	402	417	455	527	563	630	721	835
			<b>OVERALL DIMENSIONS</b> W D H			<b>SEAT DIMENSIONS</b> W D H			<b>BACK DIMENSIONS</b> W H					
			18	21	18	18	17.5	-	18	16				
			 											
  <b>Seat Unit w/Arms</b> COM Yardage: 1 Freight Class: 150 Product Weight (lbs.): 20 Cubic Feet Per Carton: 4.88 (2 per carton)	<b>Duet</b> Upholstered Seat and Back. Use with beams.	<b>6697</b>	385	410	430	462	504	520	558	630	666	733	824	938
			<b>OVERALL DIMENSIONS</b> W D H			<b>SEAT DIMENSIONS</b> W D H			<b>BACK DIMENSIONS</b> W H					
			25.5	21	18	18	17.5	-	18	16				
			 											
  <b>Armless Seat Unit</b> COM Yardage: 1 Freight Class: 150 Product Weight (lbs.): 19 Cubic Feet Per Carton: 3.25 (2 per carton)	<b>Duet</b> Upholstered Seat and Back. Use with beams.	<b>6698</b>	314	339	360	391	434	449	488	560	595	663	753	868
			<b>OVERALL DIMENSIONS</b> W D H			<b>SEAT DIMENSIONS</b> W D H			<b>BACK DIMENSIONS</b> W H					
			18	21	18	18	17.5	-	18	16				
			 											
  <b>Armless Seat Unit</b> COM Yardage: N/A Freight Class: 150 Product Weight (lbs.): 17 Cubic Feet Per Carton: 6.5 (2 per carton)	<b>Popcorn</b> Polypropylene Seat and Back. use with beam	<b>6717</b>	247	-	-	-	-	-	-	-	-	-	-	-
			<b>OVERALL DIMENSIONS</b> W D H			<b>SEAT DIMENSIONS</b> W D H			<b>BACK DIMENSIONS</b> W H					
			20	21	18	18	18	-	19.5	16				
														
  <b>Armless Seat Unit</b> COM Yardage: 0.75 Freight Class: 150 Product Weight (lbs.): 18 Cubic Feet Per Carton: 6.5 (2 per carton)	<b>Popcorn</b> Upholstered Seat and Polypropylene Back. Use with beam.	<b>6719</b>	322	343	360	386	421	436	469	521	560	604	695	791
			<b>OVERALL DIMENSIONS</b> W D H			<b>SEAT DIMENSIONS</b> W D H			<b>BACK DIMENSIONS</b> W H					
			20	21	18	18	18	-	19.5	16				
														

DESCRIPTION	FEATURES	MODEL#	STANDARD TEXTILE GRADES											
			1	2	3	4	5	6	7	8	9	10	11	12
 <p><b>Seat Unit w/Arms</b> COM Yardage: 1.25 Freight Class: 300 Product Weight (lbs.): 20 Cubic Feet Per Carton: 9.75</p>	<p><b>Sidero</b> Upholstered Seat and Back. Use with beam.</p>	<p><b>6930</b></p>	512	546	575	616	676	703	757	842	908	981	1131	1291
			<p><b>OVERALL DIMENSIONS</b></p>			<p><b>SEAT DIMENSIONS</b></p>			<p><b>BACK DIMENSIONS</b></p>					
			W	D	H	W	D	H	W	H				
			25.5	23.5	19	19.5	18	-	19	15.5				
			<p><b>RTA 00</b></p>											
 <p><b>Armless Seat Unit</b> COM Yardage: 1.25 Freight Class: 300 Product Weight (lbs.): 18 Cubic Feet Per Carton: 9.75</p>	<p><b>Sidero</b> Upholstered Seat and Back. Use with beam.</p>	<p><b>6931</b></p>	468	503	532	573	632	660	713	798	865	938	1087	1248
			<p><b>OVERALL DIMENSIONS</b></p>			<p><b>SEAT DIMENSIONS</b></p>			<p><b>BACK DIMENSIONS</b></p>					
			W	D	H	W	D	H	W	H				
			21	23.5	19	19.5	18	-	19	15.5				
			<p><b>RTA 00</b></p>											
 <p><b>Armless Seat Unit</b> COM Yardage: N/A Freight Class: 250 Product Weight (lbs.): 12 Cubic Feet Per Carton: 3.25 (2 per carton)</p>	<p><b>Sonic</b> Polypropylene Seat and Back. Use with Beam.</p>	<p><b>6501</b></p>	301	-	-	-	-	-	-	-	-	-	-	-
			<p><b>OVERALL DIMENSIONS</b></p>			<p><b>SEAT DIMENSIONS</b></p>			<p><b>BACK DIMENSIONS</b></p>					
			W	D	H	W	D	H	W	H				
			20	21.5	17	17	16	-	17	15				
			<p><b>RTA 00</b> </p>											
 <p><b>Armless Seat Unit</b> COM Yardage: 0.75 Freight Class: 250 Product Weight (lbs.): 12 Cubic Feet Per Carton: 3.25 (2 per carton)</p>	<p><b>Sonic</b> Upholstered Seat and Polypropylene Back. Use with Beam.</p>	<p><b>6502</b></p>	337	358	373	397	433	443	475	531	558	611	683	774
			<p><b>OVERALL DIMENSIONS</b></p>			<p><b>SEAT DIMENSIONS</b></p>			<p><b>BACK DIMENSIONS</b></p>					
			W	D	H	W	D	H	W	H				
			20	22	17	17	16	-	17	15				
			<p><b>RTA 00</b> </p>											
 <p><b>Armless Seat Unit</b> COM Yardage: 0.75 Freight Class: 150 Product Weight (lbs.): 13 Cubic Feet Per Carton: 3.25 (2 per carton)</p>	<p><b>Sonic</b> Upholstered Seat and Back. Use with Beam.</p>	<p><b>6503</b></p>	370	390	406	430	465	477	506	564	591	644	717	806
			<p><b>OVERALL DIMENSIONS</b></p>			<p><b>SEAT DIMENSIONS</b></p>			<p><b>BACK DIMENSIONS</b></p>					
			W	D	H	W	D	H	W	H				
			20	22	17	17	16	-	17	15				
			<p><b>RTA 00</b> </p>											

DESCRIPTION	FEATURES	MODEL#	STANDARD TEXTILE GRADES												
			1	2	3	4	5	6	7	8	9	10	11	12	
 <b>6504</b>	 <b>6504MB</b> (Mesh Back)		353	-	-	-	-	-	-	-	-	-	-		
			383	-	-	-	-	-	-	-	-	-	-	-	
<b>Seat Unit w/Arms</b> COM Yardage: N/A Freight Class: 150 Product Weight (lbs.): 13 Cubic Feet Per Carton: 3.25 (2 per carton)			<b>Sonic</b> Polypropylene Seat. Use with Beam.			<b>OVERALL DIMENSIONS</b> W D H			<b>SEAT DIMENSIONS</b> W D H			<b>BACK DIMENSIONS</b> W H			
			23	21.5	17	17	16	-	17	15					
			<b>RTA 00</b>												
 <b>6505</b>	 <b>6505MB</b> (Mesh Back)		387	406	423	446	482	492	524	579	607	660	733	823	
			504	526	542	568	603	618	651	703	742	786	877	973	
<b>Seat Unit w/Arms</b> COM Yardage: 0.75 Freight Class: 22 Product Weight (lbs.): 13 Cubic Feet Per Carton: 3.25 (2 per carton)			<b>Sonic</b> Upholstered Seat. Use with Beam.			<b>OVERALL DIMENSIONS</b> W D H			<b>SEAT DIMENSIONS</b> W D H			<b>BACK DIMENSIONS</b> W H			
			23	22	17	17	16	-	17	15					
			<b>RTA 00</b>												
 <b>6506</b>			418	439	455	479	514	526	556	613	641	694	767	855	
			<b>OVERALL DIMENSIONS</b> W D H			<b>SEAT DIMENSIONS</b> W D H			<b>BACK DIMENSIONS</b> W H						
<b>Seat Unit w/Arms</b> COM Yardage: 0.75 Freight Class: 150 Product Weight (lbs.): 14 Cubic Feet Per Carton: 3.25 (2 per carton)			<b>Sonic</b> Upholstered Seat and Back Use with Beam.			23 22 17			17 16 -			17 15			
			<b>RTA 00</b>												
 <b>6340</b>			616	645	667	701	748	770	813	881	934	992	1113	1242	
			<b>OVERALL DIMENSIONS</b> W D H			<b>SEAT DIMENSIONS</b> W D H			<b>BACK DIMENSIONS</b> W H						
<b>Armless Seat Unit</b> COM Yardage: 1 Freight Class: 250 Product Weight (lbs.): 20 Cubic Feet Per Carton: 7.25			<b>Vion</b> Upholstered Seat and Mesh Back. Use with beam.			21 23.5 20.5			17.5 18 -			19 17			
			<b>RTA 00</b>												
 <b>6341</b>			718	753	781	823	882	909	963	1049	1115	1188	1337	1498	
			<b>OVERALL DIMENSIONS</b> W D H			<b>SEAT DIMENSIONS</b> W D H			<b>BACK DIMENSIONS</b> W H						
<b>Armless Seat Unit</b> COM Yardage: 1 Freight Class: 250 Product Weight (lbs.): 20 Cubic Feet Per Carton: 7.25			<b>Vion</b> Upholstered Seat and Back. Use with beam.			21 23.5 20.5			17.5 18 -			19 17			
			<b>RTA 00</b>												

DESCRIPTION	FEATURES	MODEL#	STANDARD TEXTILE GRADES											
			1	2	3	4	5	6	7	8	9	10	11	12
 <p><b>Seat Unit w/Arms</b> COM Yardage: 1 Freight Class: 250 Product Weight (lbs.): 21 Cubic Feet Per Carton: 9.75</p>	<p><b>Vion</b> Upholstered Seat and Mesh Back. Use with beam.</p>	<p><b>6342</b></p>	571	599	622	655	702	724	768	835	887	946	1067	1195
			<p><b>OVERALL DIMENSIONS</b></p>			<p><b>SEAT DIMENSIONS</b></p>			<p><b>BACK DIMENSIONS</b></p>					
			<b>W</b>	<b>D</b>	<b>H</b>	<b>W</b>	<b>D</b>	<b>H</b>	<b>W</b>	<b>H</b>				
			25.5	23.5	20.5	17.5	18	-	19	17				
			<p><b>RTA 00</b></p>											
 <p><b>Seat Unit w/Arms</b> COM Yardage: 1 Freight Class: 250 Product Weight (lbs.): 21 Cubic Feet Per Carton: 9.75</p>	<p><b>Vion</b> Upholstered Seat and Back. Use with beam.</p>	<p><b>6343</b></p>	660	695	723	764	823	850	904	989	1055	1128	1279	1439
			<p><b>OVERALL DIMENSIONS</b></p>			<p><b>SEAT DIMENSIONS</b></p>			<p><b>BACK DIMENSIONS</b></p>					
			<b>W</b>	<b>D</b>	<b>H</b>	<b>W</b>	<b>D</b>	<b>H</b>	<b>W</b>	<b>H</b>				
			25.5	23.5	20.5	17.5	18	-	19	17				
			<p><b>RTA 00</b></p>											

**CAPRICE™**



model 3365 (TUN)



model 3365C (TUN)





**STANDARD FEATURES**

- Modern light scale guest seating.
- Durable molded armcaps in Black Only.
- Frame is standard in a Tungsten colored finish (TUN).
- Standard with Black “bullet style” glides.
- Non-castered models can be joined together using ganging clamp model 6522.
- **C1** dual wheel carpet casters are standard on models 3365C and 3365CLM.
- Does not stack.

**OPTIONAL FEATURES**

- Frame optional in a Charcoal Grey (**CHR**) and Black (**BK**) finishes are available at no additional charge. Please Specify. A Chrome (**CH**) finish is also available. Add \$30 for side chairs. Add \$110 for counter and bar stools. Please Specify.
- Optional steel cushioned glides (**B**) are available. Add \$23. Please specify.
- For hard surface flooring casters, specify **C9R**. Add \$51.
- Available in all standard GLOBAL carded Fabrics, Vinyls, and Leathers.

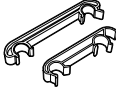

DESCRIPTION	FEATURES	MODEL#	STANDARD TEXTILE GRADES													
			1	2	3	4	5	6	7	8	9	10	11	12		
  <b>Armchair</b> 4 Legged COM Yardage: 1.25 Freight Class: 300 Product Weight (lbs.): 22 Cubic Feet Per Carton: 14.50	Does not stack.	<b>3365</b>	624	656	684	724	778	800	849	943	988	1074	1192	1338		
		<b>3365LM</b>	-	-	-	-	785	-	-	946	998	1079	1201	1350		
		<b>OVERALL DIMENSIONS</b>		<b>SEAT DIMENSIONS</b>			<b>BACK DIMENSIONS</b>									
		<b>W</b>	<b>D</b>	<b>H</b>	<b>W</b>	<b>D</b>	<b>H</b>	<b>W</b>	<b>H</b>							
		25	24	31.5	19.5	19.5	18.5	18	13							
			<b>RTA 00</b>													
  <b>Armchair</b> 4 Legged w/casters COM Yardage: 1.25 Freight Class: 300 Product Weight (lbs.): 23 Cubic Feet Per Carton: 14.50	Does not stack.	<b>3365C</b>	726	760	786	828	882	904	954	1049	1095	1183	1303	1453		
		<b>3365CLM</b>	-	-	-	-	894	-	-	1058	1109	1192	1317	1468		
		<b>OVERALL DIMENSIONS</b>		<b>SEAT DIMENSIONS</b>			<b>BACK DIMENSIONS</b>									
		<b>W</b>	<b>D</b>	<b>H</b>	<b>W</b>	<b>D</b>	<b>H</b>	<b>W</b>	<b>H</b>							
		25	23.5	32.5	19.5	18.5	18	18	14.5							
			<b>RTA 00</b>													
  <b>Barstool</b> - 4 Legged COM Yardage: 1.25 Freight Class: 300 Product Weight (lbs.): 32 Cubic Feet Per Carton: 20	Does not stack.	<b>3369</b>	789	823	849	890	948	969	1017	1113	1157	1247	1365	1517		
		<b>3369LM</b>	-	-	-	-	912	-	-	1078	1130	1213	1337	1486		
		<b>OVERALL DIMENSIONS</b>		<b>SEAT DIMENSIONS</b>			<b>BACK DIMENSIONS</b>									
		<b>W</b>	<b>D</b>	<b>H</b>	<b>W</b>	<b>D</b>	<b>H</b>	<b>W</b>	<b>H</b>							
		25	26.5	45.5	19.5	19.5	30.5	18	13							
			<b>RTA 00</b>													

DESCRIPTION	FEATURES	MODEL#	STANDARD TEXTILE GRADES												
			1	2	3	4	5	6	7	8	9	10	11	12	
 <p><b>Ganging Brackets</b>                      COM Yardage: N/A                      Freight Class: 70                      Product Weight (lbs.): .07                      Cubic Feet Per Carton: 1 (25 per Carton)</p>		6522	22	-	-	-	-	-	-	-	-	-	-	-	-
			OVERALL DIMENSIONS			SEAT DIMENSIONS			BACK DIMENSIONS						
			W	D	H	W	D	H	W	H					
			0.87	7.75	1.5	-	-	-	-	-					
			RTA 00		ups										



**CHAP™**



**Wood Back Armchair model 1010**



**Upholstered Back Armchair model 1015**



**Upholstered Round Back Armchair model 1002**



**Wood Round Back Armchair model 1003**

**STANDARD FEATURES**

- Chap offers mid-century modern styling in a finely crafted beechwood armchair series.
- Upholstered, wood and open frame backs available.
- Straight back models are available with exposed wood or upholstered front seat rails.
- Custom stain matching is not available on models 1002 and 1003.
- Offered in Fabric, Vinyl and Leather. Not available in Leather/Mock Leather combination.
- Does not stack.

**OPTIONAL FEATURES**

- Round back models 1002 and 1003: frame is available in select finishes only (\*).
- **Frame finish**  
**(AAM)** Absolute\*  
**(BKM)** Black\*  
**(ACM)** Cherry\*  
**(EOM)** English Oak  
**(ECM)** Espresso Cafe\*  
**(TFM)** Fruitwood  
**(HGM)** Gray  
**(AHM)** Honey  
**(TMM)** Mahogany\*  
**(AVM)** Maple  
**(MWM)** Medium Walnut\*  
**(ASM)** Night\*  
**(SKM)** Shaker Cherry\*  
**(TWM)** Walnut\*  
**(WTM)** WC Cream\*  
**(WHM)** White\*  
**(WCM)** Winter Cherry  
 Please Specify.  
 \*Round back models 1002 and 1003 available in these finishes only.

DESCRIPTION	FEATURES	MODEL#	STANDARD FABRIC GRADES											
			1	2	3	4	5	6	7	8	9	10	11	12



**Wood Back Armchair w/ Upholstered Seat Front**  
 COM Yardage: 1.00  
 Freight Class: 300  
 Product Weight (lbs.): 21  
 Cubic Feet Per Carton: 11.75

Does not stack.  
 Ergonomic Features  
 M, N

<b>1010</b>	880	906	925	954	996	1015	1052	1112	1158	1209	1315	1427
-------------	-----	-----	-----	-----	-----	------	------	------	------	------	------	------

OVERALL DIMENSIONS			SEAT DIMENSIONS			BACK DIMENSIONS	
W	D	H	W	D	H	W	H
23.5	24.5	31	21	20	18	20.5	13.5

**RTA 00**



**Upholstered Back Armchair w/ Upholstered Seat Front**  
 COM Yardage: 1.75  
 Freight Class: 300  
 Product Weight (lbs.): 21  
 Cubic Feet Per Carton: 11.75

Does not stack.  
 Ergonomic Features  
 M, N

<b>1011</b>	825	868	902	952	1023	1057	1121	1224	1303	1391	1572	1761
-------------	-----	-----	-----	-----	------	------	------	------	------	------	------	------

OVERALL DIMENSIONS			SEAT DIMENSIONS			BACK DIMENSIONS	
W	D	H	W	D	H	W	H
23.5	24.5	31.5	21	20	18	20.5	13.5

**RTA 00**





**Wood Back Armchair w/ Wood Front Rail**  
 COM Yardage: 1.00  
 Freight Class: 300  
 Product Weight (lbs.): 21  
 Cubic Feet Per Carton: 11.75

Does not stack.  
 Ergonomic Features  
 M, N

<b>1014</b>	880	906	925	954	996	1015	1052	1112	1158	1209	1315	1427
-------------	-----	-----	-----	-----	-----	------	------	------	------	------	------	------

OVERALL DIMENSIONS			SEAT DIMENSIONS			BACK DIMENSIONS	
W	D	H	W	D	H	W	H
23.5	24.5	31	21	20	18	20.5	13.5

**RTA 00**

DESCRIPTION	FEATURES	MODEL#	STANDARD FABRIC GRADES											
			1	2	3	4	5	6	7	8	9	10	11	12
 <p><b>Upholstered Back Armchair w/ Wood Front Rail</b>                      COM Yardage: 1.75                      Freight Class: 300                      Product Weight (lbs.): 21                      Cubic Feet Per Carton: 11.75</p>	Does not stack.  Ergonomic Features M, N	<b>1015</b>	825	868	902	952	1023	1057	1121	1224	1303	1391	1572	1761
			<b>OVERALL DIMENSIONS</b> W    D    H			<b>SEAT DIMENSIONS</b> W    D    H			<b>BACK DIMENSIONS</b> W    H					
			23.5	24.5	31.5	21	20	18	20.5	13.5				
			<b>RTA 00</b>											
 <p><b>Upholstered Round Back Armchair w/ Upholstered Seat Front</b>                      COM Yardage: 1.50                      Freight Class: 300                      Product Weight (lbs.): 20                      Cubic Feet Per Carton: 13.25</p>	Does not stack.  Ergonomic Features M, N	<b>1002</b>	995	1031	1058	1100	1158	1186	1239	1324	1389	1461	1611	1770
			<b>OVERALL DIMENSIONS</b> W    D    H			<b>SEAT DIMENSIONS</b> W    D    H			<b>BACK DIMENSIONS</b> W    H					
			24.5	24.5	30	22	20	18	20	12.5				
			<b>RTA 00</b>											
 <p><b>Wood Round Back Armchair w/ Upholstered Seat Front</b>                      COM Yardage: 1.00                      Freight Class: 300                      Product Weight (lbs.): 21                      Cubic Feet Per Carton: 13.25</p>	Does not stack.  Ergonomic Features M, N	<b>1003</b>	880	906	925	954	996	1015	1052	1112	1158	1209	1315	1427
			<b>OVERALL DIMENSIONS</b> W    D    H			<b>SEAT DIMENSIONS</b> W    D    H			<b>BACK DIMENSIONS</b> W    H					
			24.5	24.5	30	22	20	18	20	12.5				
			<b>RTA 00</b>											

COMET™



model 2171 (BK)



model 2172 (TUN)



model 2174 (TUN)



model 2183 (BK)

STANDARD FEATURES

- Reinforced models incorporate welded corner gussets for additional strength and support.
- Heavy Duty models 2173 and 2174 use Ultracell seat foam for lasting comfort.
- Models 2171 and 2172 stack 5 high on floor or 8 high on dolly 2125WS for easy storage.
- **WS** models have a wall saver frame design.
- Models with corner gussets are not recommended for stacking due to their heavy duty design.
- Stacked chairs may leave frame impressions in chair(s) below.
- Frames are standard in Black (**BK**).
- Tables are available in Black (**BK**) Only. Tables for use only when mounted to 2 or more Comet chairs.
- Two ganging plates are packed at no charge with each table to attach to two chairs only. Order separately for additional chair-to-chair ganging.
- All Specifications and Pricing are for 1 chair.

OPTIONAL FEATURES

- An optional Tungsten (**TUN**) colored finish is available. No additional charge. Please Specify.
- Optional steel cushioned glides (**B**) are available on models 2171, 2172, 2173, 2174, 2183, and 2184. Add \$23. Please specify.
- Available in all standard GLOBAL carded fabrics with the EXCEPTION of Leather.
- For availability of chair series in Vinyl, please contact a Global Sales Representative.

DESCRIPTION	FEATURES	MODEL#	STANDARD TEXTILE GRADES											
-------------	----------	--------	-------------------------	--	--	--	--	--	--	--	--	--	--	--



2171



2171WS

**Nesting Chair**  
COM Yardage: 1  
Freight Class: 150  
Product Weight (lbs.): 17  
Cubic Feet Per Carton: 3.92 (3 per carton)

Stacks 5 high on floor.  
Stacks 8 high on dolly.  
Ergonomic Features:  
M, N

	1	2	3	4	5	6	7	8	9	10	11	12
<b>2171</b>	250	277	298	328	373	392	428	503	540	611	703	822
<b>2171WS</b> Wall Saver	288	317	337	370	416	430	471	546	585	655	751	871

OVERALL DIMENSIONS			SEAT DIMENSIONS			BACK DIMENSIONS	
W	D	H	W	D	H	W	H
23	22	32.5	18	17	18.5	17.5	15

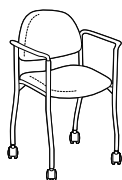

**Reinforced Armchair w/casters**  
COM Yardage: 1  
Freight Class: 250  
Product Weight (lbs.): 14  
Cubic Feet Per Carton: 14.25 (1 per carton)

Does not stack.  
Ergonomic Features:  
M, N

	1	2	3	4	5	6	7	8	9	10	11	12
<b>2171C</b>	376	403	423	452	496	513	548	621	652	720	809	922

OVERALL DIMENSIONS			SEAT DIMENSIONS			BACK DIMENSIONS	
W	D	H	W	D	H	W	H
23	22	32.5	18	17.5	18.5	17	14

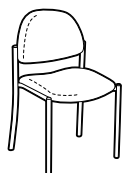

2172



2172WS

**Armless Stacking Chair**  
COM Yardage: 1  
Freight Class: 250  
Product Weight (lbs.): 14  
Cubic Feet Per Carton: 14.25 (3 per carton)

Stacks 5 high on floor.  
Ergonomic Features:  
M, N

	1	2	3	4	5	6	7	8	9	10	11	12
<b>2172</b>	189	215	236	268	313	328	368	443	478	546	642	760
<b>2172WS</b> Wall Saver	228	257	278	309	355	371	412	488	524	595	691	810

OVERALL DIMENSIONS			SEAT DIMENSIONS			BACK DIMENSIONS	
W	D	H	W	D	H	W	H
19	22	32.5	18	17.5	18.5	17.5	14



DESCRIPTION	FEATURES	MODEL#	STANDARD TEXTILE GRADES											
			1	2	3	4	5	6	7	8	9	10	11	12

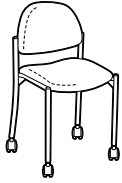

**Reinforced Armless Chair** w/casters  
 COM Yardage: 1  
 Freight Class: 250  
 Product Weight (lbs.): 14  
 Cubic Feet Per Carton: 11.75 (3 per carton)

Does not stack.  
 Ergonomic Features:  
 M, N

<b>2172C</b>	309	335	354	386	426	442	479	551	587	651	741	852
--------------	-----	-----	-----	-----	-----	-----	-----	-----	-----	-----	-----	-----

OVERALL DIMENSIONS			SEAT DIMENSIONS			BACK DIMENSIONS	
W	D	H	W	D	H	W	H
19	22	32.5	17.5	17.5	14	17	15



2173



2173WS

**Reinforced Armchair**  
 COM Yardage: 1  
 Freight Class: 250  
 Product Weight (lbs.): 14  
 Cubic Feet Per Carton: 14.25 (3 per carton)

Does not stack.  
 Ergonomic Features:  
 M, N

<b>2173</b>	349	375	396	427	472	490	528	604	641	709	803	921
-------------	-----	-----	-----	-----	-----	-----	-----	-----	-----	-----	-----	-----

<b>2173WS</b> Wall Saver	392	419	441	472	519	535	574	650	688	758	853	974
-----------------------------	-----	-----	-----	-----	-----	-----	-----	-----	-----	-----	-----	-----

OVERALL DIMENSIONS			SEAT DIMENSIONS			BACK DIMENSIONS	
W	D	H	W	D	H	W	H
23	22	32	18	17.5	18.5	17.5	14



2174

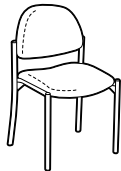

2174WS

**Reinforced Armless Chair**  
 COM Yardage: 1  
 Freight Class: 250  
 Product Weight (lbs.): 14.33  
 Cubic Feet Per Carton: 11.5 (3 per carton)

Does not stack.  
 Ergonomic Features:  
 M, N

<b>2174</b>	284	312	332	363	406	424	464	539	573	644	738	853
-------------	-----	-----	-----	-----	-----	-----	-----	-----	-----	-----	-----	-----

<b>2174WS</b> Wall Saver	327	355	376	409	454	470	512	588	624	695	791	909
-----------------------------	-----	-----	-----	-----	-----	-----	-----	-----	-----	-----	-----	-----

OVERALL DIMENSIONS			SEAT DIMENSIONS			BACK DIMENSIONS	
W	D	H	W	D	H	W	H
20	22	32	18	17	18.5	17.5	13.5

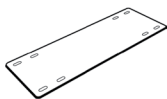

**Ganging Plate**  
 COM Yardage: N/A  
 Freight Class: 70  
 Product Weight (lbs.): 2.10  
 Cubic Feet Per Carton: .10

<b>2176</b>	59	-	-	-	-	-	-	-	-	-	-	-
-------------	----	---	---	---	---	---	---	---	---	---	---	---

OVERALL DIMENSIONS			SEAT DIMENSIONS			BACK DIMENSIONS	
W	D	H	W	D	H	W	H
13.25	4.75	0.06	-	-	-	-	-

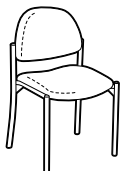









**Corner Table** Radius  
 COM Yardage: N/A  
 Freight Class: 70  
 Product Weight (lbs.): 23  
 Cubic Feet Per Carton: 1.30

<b>2178</b> Radius	227	-	-	-	-	-	-	-	-	-	-	-
-----------------------	-----	---	---	---	---	---	---	---	---	---	---	---

OVERALL DIMENSIONS			SEAT DIMENSIONS			BACK DIMENSIONS	
W	D	H	W	D	H	W	H
18	18	17.5	-	-	-	-	-



DESCRIPTION	FEATURES	MODEL#	STANDARD TEXTILE GRADES													
			1	2	3	4	5	6	7	8	9	10	11	12		
 <p><b>Corner Table</b> Crescent COM Yardage: N/A Freight Class: 85 Product Weight (lbs.): 43 Cubic Feet Per Carton: 3.50</p>		2179 Crescent	319	-	-	-	-	-	-	-	-	-	-	-		
			<b>OVERALL DIMENSIONS</b>			<b>SEAT DIMENSIONS</b>			<b>BACK DIMENSIONS</b>							
			<b>W</b>	<b>D</b>	<b>H</b>	<b>W</b>	<b>D</b>	<b>H</b>	<b>W</b>	<b>H</b>						
			40.5	18	17.5	-	-	-	-	-						
			<b>RTA 8</b>													
 <p><b>Ganging Clamp</b> COM Yardage: N/A Freight Class: 70 Product Weight (lbs.): 1 Cubic Feet Per Carton: 1</p>		2180	22	-	-	-	-	-	-	-	-	-	-			
			<b>OVERALL DIMENSIONS</b>			<b>SEAT DIMENSIONS</b>			<b>BACK DIMENSIONS</b>							
			<b>W</b>	<b>D</b>	<b>H</b>	<b>W</b>	<b>D</b>	<b>H</b>	<b>W</b>	<b>H</b>						
			0.87	7.75	1.5	-	-	-	-	-						
			<b>RTA 00</b>													
 <p><b>Reinforced Armchair</b> Square Back COM Yardage: 1 Freight Class: 250 Product Weight (lbs.): 15.33 Cubic Feet Per Carton: 4.17 (3 per carton)</p>	Does not stack. Ergonomic Features: M, N	2183	300	327	348	379	424	442	479	556	592	662	754	873		
			<b>OVERALL DIMENSIONS</b>			<b>SEAT DIMENSIONS</b>			<b>BACK DIMENSIONS</b>							
			<b>W</b>	<b>D</b>	<b>H</b>	<b>W</b>	<b>D</b>	<b>H</b>	<b>W</b>	<b>H</b>						
			23	20	32	18	17.5	18.5	18	13.5						
			<b>RTA 00</b>													
 <p><b>Reinforced Armless Chair</b> Square Back COM Yardage: 1 Freight Class: 250 Product Weight (lbs.): 14.33 Cubic Feet Per Carton: 4.17 (3 per carton)</p>	Does not stack. Ergonomic Features: M, N	2184	236	263	284	316	360	375	417	490	525	595	689	806		
			<b>OVERALL DIMENSIONS</b>			<b>SEAT DIMENSIONS</b>			<b>BACK DIMENSIONS</b>							
			<b>W</b>	<b>D</b>	<b>H</b>	<b>W</b>	<b>D</b>	<b>H</b>	<b>W</b>	<b>H</b>						
			19.5	20	32	18	17.5	18.5	18	13.5						
			<b>RTA 00</b>													

DIPLOMAT





model 2105

STANDARD FEATURES

- A contoured seat and back are accented by wood arms providing comfort and classic styling.
- For commentary task chairs see page 42.
- Models 2105 and 2108 can be joined together using model 6526 ganging clamp.
- C1 casters are standard on tilter models.
- When upholstered in Leather or Leather Mock, models will be in all Leather or in all Leather Mock.
- Does not stack.

OPTIONAL FEATURES

- Frames are standard in a Black sandtex finish (BK). Optional Tungsten (TUN) frame finish at no upcharge and Chrome (CHM) frame finish, please add \$45.
- Wood capped arms are available in Absolute (AAM), Black (BKM), Cherry (ACM), Espresso Cafe (ECM), English Oak (EOM), Fruitwood (TFM), Gray (HGM), Honey (AHM), Mahogany (TMM), Maple (AVM), Medium Walnut (MWM), Night (ASM), Shaker Cherry (SKM), Walnut (TWM), WC Cream (WTM), White (WHM) and Winter Cherry (WCM). Please Specify. Genuine maple faced veneers and solids are used.
- Optional steel cushioned glides (B) on model 2105. Add \$23. Please specify.

DESCRIPTION	FEATURES	MODEL#	STANDARD TEXTILE GRADES													
			1	2	3	4	5	6	7	8	9	10	11	12		
 <p><b>Armchair</b> Wood caps arms COM Yardage: 1.25 Freight Class: 250 Product Weight (lbs.): 20 Cubic Feet Per Carton: 11.75</p>	<p>Does not stack.</p> <p>Ergonomic Features: M, N</p>	<p><b>2105</b></p>	556	589	613	651	706	726	773	864	907	991	1106	1248		
			<b>OVERALL DIMENSIONS</b>			<b>SEAT DIMENSIONS</b>			<b>BACK DIMENSIONS</b>							
			<b>W</b>	<b>D</b>	<b>H</b>	<b>W</b>	<b>D</b>	<b>H</b>	<b>W</b>	<b>H</b>						
			24	22	34.5	20.5	17	18.5	20.5	16						
			<p><b>RTA 00</b></p>													
 <p><b>Armless Side Chair</b> COM Yardage: 1.25 Freight Class: 300 Product Weight (lbs.): 22 Cubic Feet Per Carton: 11.75</p>	<p>Does not stack.</p> <p>Ergonomic Features: M, N</p>	<p><b>2108</b></p>	393	426	452	494	551	571	622	716	763	850	971	1120		
			<b>OVERALL DIMENSIONS</b>			<b>SEAT DIMENSIONS</b>			<b>BACK DIMENSIONS</b>							
			<b>W</b>	<b>D</b>	<b>H</b>	<b>W</b>	<b>D</b>	<b>H</b>	<b>W</b>	<b>H</b>						
			21.5	22	34.5	20.5	17	18.5	20.5	16						
			<p><b>RTA 00</b></p>													
 <p><b>Armless Barstool</b> COM Yardage: 1.25 Freight Class: 250 Product Weight (lbs.): 30 Cubic Feet Per Carton: 14.75</p>	<p>Does not stack.</p> <p>Ergonomic Features: M, N</p>	<p><b>2109</b></p>	567	599	627	667	725	744	796	890	936	1024	1144	1292		
			<b>OVERALL DIMENSIONS</b>			<b>SEAT DIMENSIONS</b>			<b>BACK DIMENSIONS</b>							
			<b>W</b>	<b>D</b>	<b>H</b>	<b>W</b>	<b>D</b>	<b>H</b>	<b>W</b>	<b>H</b>						
			21	23.5	44.5	20	17	28	20.5	17.5						
			<p><b>RTA 00</b></p>													

DUET™



model 6620



model 6621G



model 6627



model 6632



model 6692 (2 units) on 6500S2 (Beam)

STANDARD FEATURES

- Unique high density seating that is both comfortable and durable.
- Tablet arms are extremely rugged and meets ANSI-BIFMA testing requirements. Tablet hinges up to allow ease of egress. Tablet slides forward and back to accommodate any body size comfortably. Tablet models do not stack.
- Standard tablet (**D8**) size is 18"D x 14 1/2"W and is made of black polymer. Tablets are attached at the left or right (as seated). Tablet arms are not available on stools.
- **WS** models have a wall saver frame design; the base touches the wall before the upper back to protect the wall from damage.
- Armless "**G**" models feature a patented interlocking feature that allows chairs to be ganged together in rows.
- Model 6626 ganging clamp set is available for use on all armchairs and standard armless models. These brackets snap on the front and rear of the sled base allowing these models to connect together in rows. In Black finish only.
- Clear polycarbonate glides (**CG**) are standard and suitable for carpet, rubber or concrete flooring.
- Weight capacity for this series is 300 lbs.
- (**C1**) dual wheel carpet casters are standard.
- Duet beam seating consists of upper seat units (models 6690, 6691, 6692, 6693, 6697 and 6698) including mounting brackets and all hardware necessary for attachment to beam.
- For all beam components, tables and a complete list of available upper seat units, see Beam Seating series.
- **Specifications and pricing are for 1 chair.**

OPTIONAL FEATURES

- Polypropylene seats, backs and coordinating arms are available in 14 designer colors. Choose from Buzz Blue (**BZB**), Cactus (**CCT**), Carrot (**CRO**), Cloud (**IVC**), Dijon (**DJN**), Eggplant (**EGP**), Fog (**FOG**), Frost (**FRO**), Ink (**INK**), Latte (**LAB**), Night (**BLK**), Sand (**SND**), Scarlet (**SAR**), and Shadow (**SHW**).
- An optional 18 1/2"D x 18 1/2"W high pressure laminate writing tablet is available. The core is hardwood veneer plywood and the edge is bull nosed and finished in clear lacquer. This writing tablet is offered in the following finishes: Black (**D1**), Grey (**D2**), White (**D4**) and Tiger Maple (**D5**). Please specify. Add \$45 to list price on desired tablet model.
- Upholstery options: fabric, vinyl, or leather. Not available in leather/mock leather combination. Chairs will have additional stitch details when upholstered in vinyl.
- A selection of glide options is available. Glide must be chosen to best suit flooring type and site conditions.
- Glides with felt pads (**FG**) are available for vinyl sheet, cork or laminate flooring, please specify. Add \$23.
- Glides with rubber pads (**RG**) are available for vinyl, hardwood, laminate, stone or ceramic flooring, please specify. Add \$23.
- Glides with stainless steel pads (**SG**) are available for carpet or rubber flooring, please specify. Add \$23.
- For hard surface flooring casters, please specify (**C9R**). Add \$51.

	Duet Chairs Stacking Capability		Duet Stools Stacking Capability	
	Stacking on floor	Stacking on dolly #6624	Stacking on floor	Stacking on dolly
<b>Armless</b>				
Polypropylene seat & back	up to 12 high	up to 40* high	up to 12 high	N/A
Polypropylene back & upholstered seat	up to 5 high	up to 12 high	up to 5 high	N/A
Upholstered seat & back	up to 5 high	up to 12 high	up to 5 high	N/A
<b>With Arms</b>				
Polypropylene seat & back	up to 5 high	up to 24 high	up to 5 high	N/A
Polypropylene back & upholstered seat	up to 5 high	up to 12 high	up to 5 high	N/A
Upholstered seat & back	up to 5 high	up to 12 high	up to 5 high	N/A





\* THROUGH 80" DOORWAY, STACKS 36 HIGH

DESCRIPTION	FEATURES	MODEL#	STANDARD TEXTILE GRADES												
			1	2	3	4	5	6	7	8	9	10	11	12	
		6620	257	-	-	-	-	-	-	-	-	-	-	-	
<b>OVERALL DIMENSIONS</b>			<b>SEAT DIMENSIONS</b>			<b>BACK DIMENSIONS</b>									
			<b>W</b>	<b>D</b>	<b>H</b>	<b>W</b>	<b>D</b>	<b>H</b>	<b>W</b>	<b>H</b>					
			25.5	22.75	33.25	18	17.5	16.5	18	16					









**ArmChair**  
 COM Yardage: N/A  
 Freight Class: 150  
 Product Weight (lbs.):19  
 Cubic Feet Per Carton: 18.5 (4 per carton)





Stacks 5 high on floor.  
 Stacks 24 high on dolly.













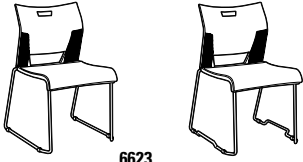

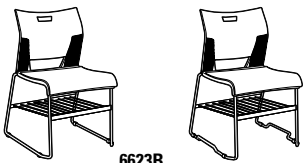
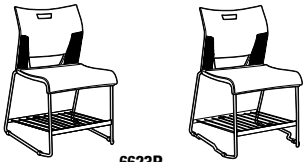
DESCRIPTION	FEATURES	MODEL#	STANDARD TEXTILE GRADES											
			1	2	3	4	5	6	7	8	9	10	11	12
 <p><b>Armchair w/Bookrack</b> COM Yardage: N/A Freight Class: 300 Product Weight (lbs.): 25 Cubic Feet Per Carton: 13.25 (1 per carton)</p>	Does not stack.	<b>6620B</b>	361	-	-	-	-	-	-	-	-	-	-	-
			<b>OVERALL DIMENSIONS</b>			<b>SEAT DIMENSIONS</b>			<b>BACK DIMENSIONS</b>					
		<b>W</b>	<b>D</b>	<b>H</b>	<b>W</b>	<b>D</b>	<b>H</b>	<b>W</b>	<b>H</b>					
		25.5	22.75	33.25	18	17.5	16.5	18	16					
			<b>RTA 00</b>											
 <p><b>Armchair w/Back pack rack</b> COM Yardage: N/A Freight Class: 300 Product Weight (lbs.): 25 Cubic Feet Per Carton: 13.25 (1 per carton)</p>	Does not stack.	<b>6620P</b>	376	-	-	-	-	-	-	-	-	-	-	
			<b>OVERALL DIMENSIONS</b>			<b>SEAT DIMENSIONS</b>			<b>BACK DIMENSIONS</b>					
		<b>W</b>	<b>D</b>	<b>H</b>	<b>W</b>	<b>D</b>	<b>H</b>	<b>W</b>	<b>H</b>					
		25.5	22.75	33.25	18	17.5	16.5	18	16					
			<b>RTA 00</b>											
 <p><b>Armchair w/Tablet</b> COM Yardage: N/A Freight Class: 150 Product Weight (lbs.): 33 Cubic Feet Per Carton: 8 (2 per carton)</p>	Does not stack.	<b>6620TR</b> <b>6620TL</b>	502	-	-	-	-	-	-	-	-	-	-	
			<b>OVERALL DIMENSIONS</b>			<b>SEAT DIMENSIONS</b>			<b>BACK DIMENSIONS</b>					
		<b>W</b>	<b>D</b>	<b>H</b>	<b>W</b>	<b>D</b>	<b>H</b>	<b>W</b>	<b>H</b>					
		26.25	27.75	33.25	18	17.5	16.5	18	16					
			<b>RTA 00</b>											
 <p><b>Armchair w/Tablet and Bookrack</b> COM Yardage: N/A Freight Class: 250 Product Weight (lbs.): 34 Cubic Feet Per Carton: 16.25 (1 per carton)</p>	Does not stack.	<b>6620TRB</b> <b>6620TLB</b>	610	-	-	-	-	-	-	-	-	-	-	
			<b>OVERALL DIMENSIONS</b>			<b>SEAT DIMENSIONS</b>			<b>BACK DIMENSIONS</b>					
		<b>W</b>	<b>D</b>	<b>H</b>	<b>W</b>	<b>D</b>	<b>H</b>	<b>W</b>	<b>H</b>					
		26.25	27.75	33.25	18	17.5	16.5	18	16					
			<b>RTA 00</b>											
 <p><b>Armchair w/Tablet and Back pack rack</b> COM Yardage: N/A Freight Class: 250 Product Weight (lbs.): 34 Cubic Feet Per Carton: 16.25 (1 per carton)</p>	Does not stack.	<b>6620TRP</b> <b>6620TLP</b>	626	-	-	-	-	-	-	-	-	-	-	
			<b>OVERALL DIMENSIONS</b>			<b>SEAT DIMENSIONS</b>			<b>BACK DIMENSIONS</b>					
		<b>W</b>	<b>D</b>	<b>H</b>	<b>W</b>	<b>D</b>	<b>H</b>	<b>W</b>	<b>H</b>					
		26.25	27.75	33.25	18	17.5	16.5	18	16					
			<b>RTA 00</b>											





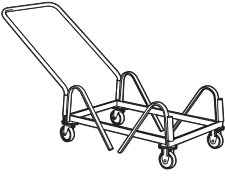

DESCRIPTION	FEATURES	MODEL#	STANDARD TEXTILE GRADES											
			1	2	3	4	5	6	7	8	9	10	11	12
 6621	 6621G		1	2	3	4	5	6	7	8	9	10	11	12
			6621	182	-	-	-	-	-	-	-	-	-	-
<b>Armless Chair</b> COM Yardage: N/A Freight Class: 150 Product Weight (lbs.): 18 Cubic Feet Per Carton: 14 (4 per carton)	Stacks 12 high on floor. Stacks 40 high on dolly.		6621G	193	-	-	-	-	-	-	-	-	-	-
			Ganging											
			<b>OVERALL DIMENSIONS</b>			<b>SEAT DIMENSIONS</b>			<b>BACK DIMENSIONS</b>					
			<b>W</b>	<b>D</b>	<b>H</b>	<b>W</b>	<b>D</b>	<b>H</b>	<b>W</b>	<b>H</b>				
			20.75	22.75	33.25	18	17.5	17	18	16				
			RTA 00		UPS									
 6621B	 6621GB		1	2	3	4	5	6	7	8	9	10	11	12
			6621B	283	-	-	-	-	-	-	-	-	-	-
<b>Armless chair w/Bookrack</b> COM Yardage: N/A Freight Class: 250 Product Weight (lbs.): 25 Cubic Feet Per Carton: 11.25 (1 per carton)	Does not stack.		6621GB	297	-	-	-	-	-	-	-	-	-	-
			Ganging											
			<b>OVERALL DIMENSIONS</b>			<b>SEAT DIMENSIONS</b>			<b>BACK DIMENSIONS</b>					
			<b>W</b>	<b>D</b>	<b>H</b>	<b>W</b>	<b>D</b>	<b>H</b>	<b>W</b>	<b>H</b>				
			20.75	22.75	33.25	18	17.5	16.5	18	16				
			RTA 00											
 6621P	 6621GP		1	2	3	4	5	6	7	8	9	10	11	12
			6621P	298	-	-	-	-	-	-	-	-	-	-
<b>Armless Chair w/Back pack rack</b> COM Yardage: N/A Freight Class: 250 Product Weight (lbs.): 25 Cubic Feet Per Carton: 11.25 (1 per carton)	Does not stack.		6621GP	313	-	-	-	-	-	-	-	-	-	-
			Ganging											
			<b>OVERALL DIMENSIONS</b>			<b>SEAT DIMENSIONS</b>			<b>BACK DIMENSIONS</b>					
			<b>W</b>	<b>D</b>	<b>H</b>	<b>W</b>	<b>D</b>	<b>H</b>	<b>W</b>	<b>H</b>				
			20.75	22.75	33.25	18	17.5	16.5	18	16				
			RTA 00											
 6621TR			1	2	3	4	5	6	7	8	9	10	11	12
			6621TR	419	-	-	-	-	-	-	-	-	-	-
<b>Armless Chair w/Tablet</b> COM Yardage: N/A Freight Class: 150 Product Weight (lbs.): 26 Cubic Feet Per Carton: 8 (2 per carton)	Does not stack.		6621TL											
			<b>OVERALL DIMENSIONS</b>			<b>SEAT DIMENSIONS</b>			<b>BACK DIMENSIONS</b>					
			<b>W</b>	<b>D</b>	<b>H</b>	<b>W</b>	<b>D</b>	<b>H</b>	<b>W</b>	<b>H</b>				
			24.5	27.75	33.25	18	17.5	16.5	18	16				
			RTA 00											
 6621TRB			1	2	3	4	5	6	7	8	9	10	11	12
			6621TRB	522	-	-	-	-	-	-	-	-	-	-
<b>Armless Chair w/Tablet and Bookrack</b> COM Yardage: N/A Freight Class: 300 Product Weight (lbs.): 27 Cubic Feet Per Carton: 16.25 (1 per carton)	Does not stack.		6621TLB											
			<b>OVERALL DIMENSIONS</b>			<b>SEAT DIMENSIONS</b>			<b>BACK DIMENSIONS</b>					
			<b>W</b>	<b>D</b>	<b>H</b>	<b>W</b>	<b>D</b>	<b>H</b>	<b>W</b>	<b>H</b>				
			24.5	27.75	33.25	18	17.5	16.5	18	16				
			RTA 00											

DESCRIPTION	FEATURES	MODEL#	STANDARD TEXTILE GRADES													
			1	2	3	4	5	6	7	8	9	10	11	12		
 <p><b>Armless Chair</b> w/Tablet and Back pack rack COM Yardage: N/A Freight Class: 300 Product Weight (lbs.): 27 Cubic Feet Per Carton: 16.25 (1 per carton)</p>	Does not stack.	6621TRP	538	-	-	-	-	-	-	-	-	-	-	-	-	
		6621TLP														
		<b>OVERALL DIMENSIONS</b>			<b>SEAT DIMENSIONS</b>			<b>BACK DIMENSIONS</b>								
		<b>W</b>	<b>D</b>	<b>H</b>	<b>W</b>	<b>D</b>	<b>H</b>	<b>W</b>	<b>H</b>							
			24.5	27.75	33.25	18	17.5	16.5	18	16						
			<b>RTA 00</b>													
 <p><b>Armchair</b> COM Yardage: 1 Freight Class: 150 Product Weight (lbs.): 25 Cubic Feet Per Carton: 22.25 (4 per carton)</p>	Upholstered Seat. Stacks 5 high on floor. Stacks 12 high on dolly.	6622	333	359	380	410	453	469	506	579	614	681	773	887		
		<b>OVERALL DIMENSIONS</b>			<b>SEAT DIMENSIONS</b>			<b>BACK DIMENSIONS</b>								
		<b>W</b>	<b>D</b>	<b>H</b>	<b>W</b>	<b>D</b>	<b>H</b>	<b>W</b>	<b>H</b>							
					25.5	23	33.25	18	17.5	17	18	16				
			<b>RTA 00</b>													
 <p><b>Armchair</b> w/Bookrack COM Yardage: 1 Freight Class: 250 Product Weight (lbs.): 29 Cubic Feet Per Carton: 13.25 (1 per carton)</p>	Upholstered Seat. Does not stack.	6622B	442	469	491	523	569	585	625	701	738	808	904	1024		
		<b>OVERALL DIMENSIONS</b>			<b>SEAT DIMENSIONS</b>			<b>BACK DIMENSIONS</b>								
		<b>W</b>	<b>D</b>	<b>H</b>	<b>W</b>	<b>D</b>	<b>H</b>	<b>W</b>	<b>H</b>							
					25.5	23	33.25	18	17.5	17	18	16				
			<b>RTA 00</b>													
 <p><b>Armchair</b> w/Back pack rack COM Yardage: 1 Freight Class: 250 Product Weight (lbs.): 29 Cubic Feet Per Carton: 13.25 (1 per carton)</p>	Upholstered Seat. Does not stack.	6622P	460	487	507	540	587	600	642	717	754	826	921	1041		
		<b>OVERALL DIMENSIONS</b>			<b>SEAT DIMENSIONS</b>			<b>BACK DIMENSIONS</b>								
		<b>W</b>	<b>D</b>	<b>H</b>	<b>W</b>	<b>D</b>	<b>H</b>	<b>W</b>	<b>H</b>							
					25.5	23	33.25	18	17.5	17	18	16				
			<b>RTA 00</b>													
 <p><b>Armchair</b> w/Tablet COM Yardage: 1 Freight Class: 250 Product Weight (lbs.): 27 Cubic Feet Per Carton: 16 (2 per carton)</p>	Upholstered Seat. Does not stack. Must specify (L) Left or (R) Right Tablet.	6622TR	589	617	641	675	724	741	784	866	905	980	1083	1212		
		6622TL														
		<b>OVERALL DIMENSIONS</b>			<b>SEAT DIMENSIONS</b>			<b>BACK DIMENSIONS</b>								
		<b>W</b>	<b>D</b>	<b>H</b>	<b>W</b>	<b>D</b>	<b>H</b>	<b>W</b>	<b>H</b>							
			26.25	27.75	33.25	18	17.5	17	18	15.5						
			<b>RTA 00</b>													

DESCRIPTION	FEATURES	MODEL#	STANDARD TEXTILE GRADES												
			1	2	3	4	5	6	7	8	9	10	11	12	
 <p><b>Armchair w/ Tablet and Bookrack</b> COM Yardage: 1 Freight Class: 250 Product Weight (lbs.): 37 Cubic Feet Per Carton: 16.25 (1 per carton)</p>	Upholstered Seat. Does not stack.	6622TRB 6622TLB	700	730	752	786	835	852	896	977	1016	1091	1194	1323	
			<b>OVERALL DIMENSIONS</b>			<b>SEAT DIMENSIONS</b>			<b>BACK DIMENSIONS</b>						
		<b>W</b>	<b>D</b>	<b>H</b>	<b>W</b>	<b>D</b>	<b>H</b>	<b>W</b>	<b>H</b>						
		26.25	27.75	33.25	18	17.5	17	18	15.5						
			<b>RTA 00</b>												
 <p><b>Armchair w/ Tablet and Back pack rack</b> COM Yardage: 1 Freight Class: 250 Product Weight (lbs.): 37 Cubic Feet Per Carton: 16.25 (1 per carton)</p>	Upholstered Seat. Does not stack.	6622TRP 6622TLP	716	745	769	803	851	869	912	993	1033	1108	1211	1339	
			<b>OVERALL DIMENSIONS</b>			<b>SEAT DIMENSIONS</b>			<b>BACK DIMENSIONS</b>						
		<b>W</b>	<b>D</b>	<b>H</b>	<b>W</b>	<b>D</b>	<b>H</b>	<b>W</b>	<b>H</b>						
		26.25	27.75	33.25	18	17.5	17	18	15.5						
			<b>RTA 00</b>												
 <p><b>6623</b>      <b>6623G</b></p> <p><b>Armless Chair</b> COM Yardage: 1 Freight Class: 150 Product Weight (lbs.): 21 Cubic Feet Per Carton: 18.5 (4 per carton)</p>	Upholstered Seat. Stacks 5 high on floor. Stacks 12 high on dolly.	6623 6623G Ganging	253	280	300	331	373	390	427	500	535	601	694	808	
			<b>OVERALL DIMENSIONS</b>			<b>SEAT DIMENSIONS</b>			<b>BACK DIMENSIONS</b>						
		<b>W</b>	<b>D</b>	<b>H</b>	<b>W</b>	<b>D</b>	<b>H</b>	<b>W</b>	<b>H</b>						
		20.5	23	33.25	18	17.5	17	18	16						
			<b>RTA 00</b> 												
 <p><b>6623B</b>      <b>6623GB</b></p> <p><b>Armless chair w/ Bookrack</b> COM Yardage: 1 Freight Class: 250 Product Weight (lbs.): 28 Cubic Feet Per Carton: 11.25 (1 per carton)</p>	Upholstered Seat. Does not stack.	6623B 6623GB Ganging	359	388	408	441	487	501	542	617	655	726	822	942	
			<b>OVERALL DIMENSIONS</b>			<b>SEAT DIMENSIONS</b>			<b>BACK DIMENSIONS</b>						
		<b>W</b>	<b>D</b>	<b>H</b>	<b>W</b>	<b>D</b>	<b>H</b>	<b>W</b>	<b>H</b>						
		20.5	23	33.25	18	17.5	17	18	16						
			<b>RTA 00</b>												
 <p><b>6623P</b>      <b>6623GP</b></p> <p><b>Armless Chair w/ Back pack rack</b> COM Yardage: 1 Freight Class: 250 Product Weight (lbs.): 28 Cubic Feet Per Carton: 11.25 (1 per carton)</p>	Upholstered Seat. Does not stack.	6623P 6623GP Ganging	374	402	424	455	501	518	558	633	670	741	836	956	
			<b>OVERALL DIMENSIONS</b>			<b>SEAT DIMENSIONS</b>			<b>BACK DIMENSIONS</b>						
		<b>W</b>	<b>D</b>	<b>H</b>	<b>W</b>	<b>D</b>	<b>H</b>	<b>W</b>	<b>H</b>						
		20.5	23	33.25	18	17.5	17	18	16						
			<b>RTA 00</b>												

DESCRIPTION	FEATURES	MODEL#	STANDARD TEXTILE GRADES												
			1	2	3	4	5	6	7	8	9	10	11	12	
 <p><b>Armless Chair w/Tablet</b> COM Yardage: 1 Freight Class: 250 Product Weight (lbs.): 29 Cubic Feet Per Carton: 16 (2 per carton)</p>	Upholstered Seat. Does not stack.	6623TR 6623TL	500	530	553	587	635	652	696	777	816	891	994	1123	
			<b>OVERALL DIMENSIONS</b>			<b>SEAT DIMENSIONS</b>			<b>BACK DIMENSIONS</b>						
		<b>W</b>	<b>D</b>	<b>H</b>	<b>W</b>	<b>D</b>	<b>H</b>	<b>W</b>	<b>H</b>						
		24.5	27.75	33.25	18	17.5	17	18	15.5						
			<b>RTA 00</b>												
 <p><b>Armless Chair w/Tablet and Bookrack</b> COM Yardage: 1 Freight Class: 250 Product Weight (lbs.): 30 Cubic Feet Per Carton: 16.25 (1 per carton)</p>	Upholstered Seat. Does not stack.	6623TRB 6623TLB	608	637	661	695	743	761	804	885	924	1000	1103	1231	
			<b>OVERALL DIMENSIONS</b>			<b>SEAT DIMENSIONS</b>			<b>BACK DIMENSIONS</b>						
		<b>W</b>	<b>D</b>	<b>H</b>	<b>W</b>	<b>D</b>	<b>H</b>	<b>W</b>	<b>H</b>						
		24.5	27.75	33.25	18	17.5	17	18	15.5						
			<b>RTA 00</b>												
 <p><b>Armless Chair w/Tablet and Back pack rack</b> COM Yardage: 1 Freight Class: 250 Product Weight (lbs.): 35 Cubic Feet Per Carton: 16.25 (1 per carton)</p>	Upholstered Seat. Does not stack.	6623TRP 6623TLP	625	654	677	710	760	777	819	902	941	1016	1119	1248	
			<b>OVERALL DIMENSIONS</b>			<b>SEAT DIMENSIONS</b>			<b>BACK DIMENSIONS</b>						
		<b>W</b>	<b>D</b>	<b>H</b>	<b>W</b>	<b>D</b>	<b>H</b>	<b>W</b>	<b>H</b>						
		24.5	27.75	33.25	18	17.5	17	18	15.5						
			<b>RTA 00</b>												
 <p><b>Dolly</b> COM Yardage: N/A Freight Class: 150 Product Weight (lbs.): 40 Cubic Feet Per Carton: 9.50 (1 per carton)</p>		6624	541	-	-	-	-	-	-	-	-	-	-	-	
			<b>OVERALL DIMENSIONS</b>			<b>SEAT DIMENSIONS</b>			<b>BACK DIMENSIONS</b>						
		<b>W</b>	<b>D</b>	<b>H</b>	<b>W</b>	<b>D</b>	<b>H</b>	<b>W</b>	<b>H</b>						
		22.5	51	38.25	-	-	-	-	-						
			<b>RTA 1</b> 												
 <p><b>Ganging Clamp Set - 2 Clamps</b> COM Yardage: N/A Freight Class: 70 Product Weight (lbs.): .30 Cubic Feet Per Carton: .04 (1 set per carton)</p>		6626	20	-	-	-	-	-	-	-	-	-	-	-	
			<b>OVERALL DIMENSIONS</b>			<b>SEAT DIMENSIONS</b>			<b>BACK DIMENSIONS</b>						
		<b>W</b>	<b>D</b>	<b>H</b>	<b>W</b>	<b>D</b>	<b>H</b>	<b>W</b>	<b>H</b>						
		1	6.5	0.75	-	-	-	-	-						
			<b>RTA 00</b> 												

DESCRIPTION	FEATURES	MODEL#	STANDARD TEXTILE GRADES											
			1	2	3	4	5	6	7	8	9	10	11	12
 <p><b>Armchair</b> COM Yardage: 1 Freight Class: 150 Product Weight (lbs.): 27 Cubic Feet Per Carton: 22.25 (4 per carton)</p>	Upholstered Seat and Back. Stacks 5 high on floor. Stacks 12 high on dolly.	<b>6627</b>	367	414	435	466	513	527	568	644	680	751	847	969
			<b>OVERALL DIMENSIONS</b>			<b>SEAT DIMENSIONS</b>			<b>BACK DIMENSIONS</b>					
			<b>W</b>	<b>D</b>	<b>H</b>	<b>W</b>	<b>D</b>	<b>H</b>	<b>W</b>	<b>H</b>				
			25.5	23	33.25	18	17.5	17	18	16				
			<b>RTA 00</b>											
 <p><b>Armchair w/Bookrack</b> COM Yardage: 1 Freight Class: 250 Product Weight (lbs.): 31 Cubic Feet Per Carton: 13.25 (1 per carton)</p>	Upholstered Seat and Back. Does not stack.	<b>6627B</b>	476	503	525	558	604	618	660	735	773	844	939	1059
			<b>OVERALL DIMENSIONS</b>			<b>SEAT DIMENSIONS</b>			<b>BACK DIMENSIONS</b>					
			<b>W</b>	<b>D</b>	<b>H</b>	<b>W</b>	<b>D</b>	<b>H</b>	<b>W</b>	<b>H</b>				
			25.5	23	33.25	18	17.5	17	18	16				
			<b>RTA 00</b>											
 <p><b>Armchair w/Back pack rack</b> COM Yardage: 1 Freight Class: 250 Product Weight (lbs.): 31 Cubic Feet Per Carton: 13.25 (1 per carton)</p>	Upholstered Seat and Back. Does not stack.	<b>6627P</b>	495	522	543	575	622	637	678	753	791	861	956	1077
			<b>OVERALL DIMENSIONS</b>			<b>SEAT DIMENSIONS</b>			<b>BACK DIMENSIONS</b>					
			<b>W</b>	<b>D</b>	<b>H</b>	<b>W</b>	<b>D</b>	<b>H</b>	<b>W</b>	<b>H</b>				
			25.5	23	33.25	18	17.5	17	18	16				
			<b>RTA 00</b>											
 <p><b>Armchair w/Tablet</b> COM Yardage: 1 Freight Class: 250 Product Weight (lbs.): 32 Cubic Feet Per Carton: 16 (2 per carton)</p>	Upholstered Seat and Back. Does not stack.	<b>6627TR</b> <b>6627TL</b>	627	656	679	713	762	779	822	904	943	1018	1121	1250
			<b>OVERALL DIMENSIONS</b>			<b>SEAT DIMENSIONS</b>			<b>BACK DIMENSIONS</b>					
			<b>W</b>	<b>D</b>	<b>H</b>	<b>W</b>	<b>D</b>	<b>H</b>	<b>W</b>	<b>H</b>				
			26.25	27.75	33.25	18	17	17	18	15.5				
			<b>RTA 00</b>											
 <p><b>Armchair w/Tablet and Bookrack</b> COM Yardage: 1 Freight Class: 250 Product Weight (lbs.): 34 Cubic Feet Per Carton: 16.25 (1 per carton)</p>	Upholstered Seat and Back. Does not stack.	<b>6627TRB</b> <b>6627TLB</b>	739	769	792	826	874	891	935	1016	1055	1131	1233	1362
			<b>OVERALL DIMENSIONS</b>			<b>SEAT DIMENSIONS</b>			<b>BACK DIMENSIONS</b>					
			<b>W</b>	<b>D</b>	<b>H</b>	<b>W</b>	<b>D</b>	<b>H</b>	<b>W</b>	<b>H</b>				
			26.25	27.75	33.25	18	17	17	18	15.5				
			<b>RTA 00</b>											

DESCRIPTION	FEATURES	MODEL#	STANDARD TEXTILE GRADES											
			1	2	3	4	5	6	7	8	9	10	11	12



**Armchair w/Tablet and Back pack rack**  
 COM Yardage: 1  
 Freight Class: 250  
 Product Weight (lbs.): 39  
 Cubic Feet Per Carton: 16.25 (1 per carton)

Upholstered Seat and Back.  
 Does not stack.

<b>6627TRP</b>	757	786	809	843	891	909	952	1034	1073	1149	1251	1380
<b>6627TLP</b>												

OVERALL DIMENSIONS			SEAT DIMENSIONS			BACK DIMENSIONS	
W	D	H	W	D	H	W	H
26.25	27.75	33.25	18	17	17	18	15.5

RTA 00



6628



6628G

**Armless Chair**  
 COM Yardage: 1  
 Freight Class: 150  
 Product Weight (lbs.): 23  
 Cubic Feet Per Carton: 18.5 (4 per carton)

Upholstered Seat and Back.  
 Stacks 5 high on floor.  
 Stacks 12 high on dolly.

<b>6628</b>	298	341	363	394	441	457	496	572	609	679	775	897
<b>6628G</b>	308	352	373	404	451	468	507	585	621	691	786	906
Ganging												

OVERALL DIMENSIONS			SEAT DIMENSIONS			BACK DIMENSIONS	
W	D	H	W	D	H	W	H
20.5	23.	33.25	18	17	17	18	15.5

RTA 00



6628B



6628GB

**Armless chair w/Bookrack**  
 COM Yardage: 1  
 Freight Class: 250  
 Product Weight (lbs.): 30  
 Cubic Feet Per Carton: 11.25 (1 per carton)

Upholstered Seat and Back.  
 Does not stack.

<b>6628B</b>	409	437	460	491	537	552	593	668	705	776	872	992
<b>6628GB</b>	422	449	470	502	548	564	605	680	717	788	883	1004
Ganging												

OVERALL DIMENSIONS			SEAT DIMENSIONS			BACK DIMENSIONS	
W	D	H	W	D	H	W	H
20.5	23.	33.25	18	17	17	18	15.5

RTA 00



6628P



6628GP

**Armless Chair w/Back pack rack**  
 COM Yardage: 1  
 Freight Class: 250  
 Product Weight (lbs.): 30  
 Cubic Feet Per Carton: 11.25 (1 per carton)

Upholstered Seat and Back.  
 Does not stack.

<b>6628P</b>	426	453	475	507	553	569	609	684	723	793	887	1008
<b>6628GP</b>	439	466	488	520	566	580	622	697	734	805	901	1021
Ganging												

OVERALL DIMENSIONS			SEAT DIMENSIONS			BACK DIMENSIONS	
W	D	H	W	D	H	W	H
20.5	23.	33.25	18	17	17	18	15.5

RTA 00







**Armless Chair w/Tablet**  
 COM Yardage: 1  
 Freight Class: 250  
 Product Weight (lbs.): 31  
 Cubic Feet Per Carton: 16 (2 per carton)





Upholstered Seat and Back.  
 Does not stack.

<b>6628TR</b>	560	590	612	646	696	713	755	837	877	952	1054	1183
<b>6628TL</b>												







OVERALL DIMENSIONS			SEAT DIMENSIONS			BACK DIMENSIONS	
W	D	H	W	D	H	W	H
24.5	27.75	33.25	18	17	17	18	15.5



RTA 00









DESCRIPTION	FEATURES	MODEL#	STANDARD TEXTILE GRADES											
			1	2	3	4	5	6	7	8	9	10	11	12
 <p><b>Armless Chair w/ Tablet and Bookrack</b> COM Yardage: 1 Freight Class: 250 Product Weight (lbs.): 38 Cubic Feet Per Carton: 16.25 (1 per carton)</p>	Upholstered Seat and Back. Does not stack.	6628TRB 6628TLB	673	703	726	760	809	827	869	951	990	1066	1169	1297
			<b>OVERALL DIMENSIONS</b>			<b>SEAT DIMENSIONS</b>			<b>BACK DIMENSIONS</b>					
			<b>W</b>	<b>D</b>	<b>H</b>	<b>W</b>	<b>D</b>	<b>H</b>	<b>W</b>	<b>H</b>				
			24.5	16.25	33.25	18	17	17	18	15.5				
			<b>RTA 00</b>											
 <p><b>Armless Chair w/ Tablet and Back pack rack</b> COM Yardage: 1 Freight Class: 250 Product Weight (lbs.): 38 Cubic Feet Per Carton: 16.25 (1 per carton)</p>	Upholstered Seat and Back. Does not stack.	6628TRP 6628TLP	692	721	744	778	828	845	887	970	1009	1084	1187	1316
			<b>OVERALL DIMENSIONS</b>			<b>SEAT DIMENSIONS</b>			<b>BACK DIMENSIONS</b>					
			<b>W</b>	<b>D</b>	<b>H</b>	<b>W</b>	<b>D</b>	<b>H</b>	<b>W</b>	<b>H</b>				
			24.5	27.75	33.25	18	17	17	18	15.5				
			<b>RTA 00</b>											
 <p><b>Barstool with Arms</b> COM Yardage: N/A Freight Class: 250 Product Weight (lbs.): 30 Cubic Feet Per Carton: 10.75 (2 per carton)</p>	Stacks 5 high on floor.	6630	449	-	-	-	-	-	-	-	-	-	-	-
			<b>OVERALL DIMENSIONS</b>			<b>SEAT DIMENSIONS</b>			<b>BACK DIMENSIONS</b>					
			<b>W</b>	<b>D</b>	<b>H</b>	<b>W</b>	<b>D</b>	<b>H</b>	<b>W</b>	<b>H</b>				
			25.5	23.5	45	18	17.5	29.5	18	16				
			<b>RTA 00</b>											
 <p><b>Armless Barstool</b> COM Yardage: N/A Freight Class: 250 Product Weight (lbs.): 29 Cubic Feet Per Carton: 8.75 (2 per carton)</p>	Stacks 8 high on floor.	6631	334	-	-	-	-	-	-	-	-	-	-	-
			<b>OVERALL DIMENSIONS</b>			<b>SEAT DIMENSIONS</b>			<b>BACK DIMENSIONS</b>					
			<b>W</b>	<b>D</b>	<b>H</b>	<b>W</b>	<b>D</b>	<b>H</b>	<b>W</b>	<b>H</b>				
			20.75	23.5	45	18	17.5	29.5	18	16				
			<b>RTA 00</b>											
 <p><b>Barstool with Arms</b> COM Yardage: 1 Freight Class: 250 Product Weight (lbs.): 31 Cubic Feet Per Carton: 21.5 (2 per carton)</p>	Upholstered Seat Stacks 5 high on floor	6632	519	544	566	597	641	655	695	767	801	869	959	1074
			<b>OVERALL DIMENSIONS</b>			<b>SEAT DIMENSIONS</b>			<b>BACK DIMENSIONS</b>					
			<b>W</b>	<b>D</b>	<b>H</b>	<b>W</b>	<b>D</b>	<b>H</b>	<b>W</b>	<b>H</b>				
			25.5	23.5	45	18	17.5	30	18	15.5				
			<b>RTA 00</b>											

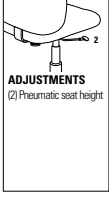

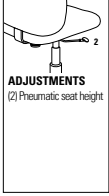

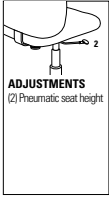

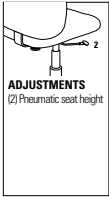

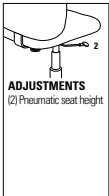
DESCRIPTION	FEATURES	MODEL#	STANDARD TEXTILE GRADES												
 <p><b>Armless Barstool</b> COM Yardage: 1 Freight Class: 250 Product Weight (lbs.): 30 Cubic Feet Per Carton: 17.5 (2 per carton)</p>	<p>Upholstered Seat. Stacks 5 high on floor.</p>	6633	1	2	3	4	5	6	7	8	9	10	11	12	
			400	427	448	478	522	537	575	647	682	750	842	955	
			<b>OVERALL DIMENSIONS</b> W D H			<b>SEAT DIMENSIONS</b> W D H			<b>BACK DIMENSIONS</b> W H						
			20.75	23.5	45	18	17.5	30	18	15.5					
			<b>RTA 00</b>												
 <p><b>Barstool with Arms</b> COM Yardage: 1 Freight Class: 250 Product Weight (lbs.): 31.50 Cubic Feet Per Carton: 10.75 (2 per carton)</p>	<p>Upholstered Seat and Back. Stacks 3 high on floor.</p>	6637	1	2	3	4	5	6	7	8	9	10	11	12	
			548	574	595	627	670	684	724	796	831	899	989	1104	
			<b>OVERALL DIMENSIONS</b> W D H			<b>SEAT DIMENSIONS</b> W D H			<b>BACK DIMENSIONS</b> W H						
			25.5	23.5	45	18	17.5	30	18	15.5					
			<b>RTA 00</b>												
 <p><b>Armless Barstool</b> COM Yardage: 1 Freight Class: 250 Product Weight (lbs.): 30.50 Cubic Feet Per Carton: 8.75 (2 per carton)</p>	<p>Upholstered Seat and Back. Stacks 3 high on floor.</p>	6638	1	2	3	4	5	6	7	8	9	10	11	12	
			469	496	517	546	591	605	644	716	751	818	909	1024	
			<b>OVERALL DIMENSIONS</b> W D H			<b>SEAT DIMENSIONS</b> W D H			<b>BACK DIMENSIONS</b> W H						
			20.75	23.5	45	18	17.5	30	18	15.5					
			<b>RTA 00</b>												
 <p><b>Counter Stool with Arms</b> COM Yardage: N/A Freight Class: 250 Product Weight (lbs.): 25 Cubic Feet Per Carton: 10.75 (2 per carton)</p>	<p>Stacks 5 high on floor.</p>	6660	1	2	3	4	5	6	7	8	9	10	11	12	
			449	-	-	-	-	-	-	-	-	-	-	-	-
			<b>OVERALL DIMENSIONS</b> W D H			<b>SEAT DIMENSIONS</b> W D H			<b>BACK DIMENSIONS</b> W H						
			25.5	23.5	39.5	18	17.5	24	18	16					
			<b>RTA 00</b>												
 <p><b>Armless Counter Stool</b> COM Yardage: N/A Freight Class: 250 Product Weight (lbs.): 24 Cubic Feet Per Carton: 8.75 (2 per carton)</p>	<p>Stacks 5 high on floor.</p>	6661	1	2	3	4	5	6	7	8	9	10	11	12	
			334	-	-	-	-	-	-	-	-	-	-	-	-
			<b>OVERALL DIMENSIONS</b> W D H			<b>SEAT DIMENSIONS</b> W D H			<b>BACK DIMENSIONS</b> W H						
			20.75	23.5	39.5	18	17.5	24	18	16					
			<b>RTA 00</b>												

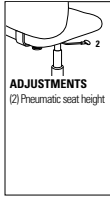

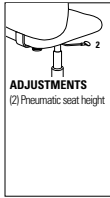

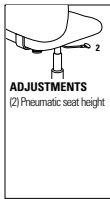

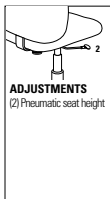

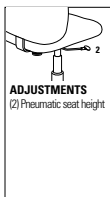

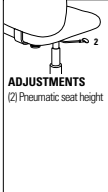

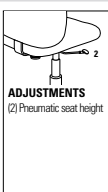

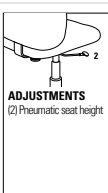
DESCRIPTION	FEATURES	MODEL#	STANDARD TEXTILE GRADES											
			1	2	3	4	5	6	7	8	9	10	11	12
 <b>Counter Stool w/Arms</b> COM Yardage: 1 Freight Class: 250 Product Weight (lbs.): 26 Cubic Feet Per Carton: 10.75 (2 per carton)	Upholstered Seat. Stacks 5 high on floor.	6662	519	544	566	597	641	655	695	767	801	869	959	1074
			<b>OVERALL DIMENSIONS</b> W D H			<b>SEAT DIMENSIONS</b> W D H			<b>BACK DIMENSIONS</b> W H					
			20.75	23.5	39.5	18	17.5	24	18	16				
			<div style="text-align: center;">RTA 00</div>											
 <b>Armless Counter Stool</b> COM Yardage: 1 Freight Class: 250 Product Weight (lbs.): 25 Cubic Feet Per Carton: 8.75 (2 per carton)	Upholstered Seat. Stacks 5 high on floor.	6663	400	427	448	478	522	537	575	647	682	750	842	955
			<b>OVERALL DIMENSIONS</b> W D H			<b>SEAT DIMENSIONS</b> W D H			<b>BACK DIMENSIONS</b> W H					
			20.75	23.5	39.5	18	17.5	24	18	16				
			<div style="text-align: center;">RTA 00</div>											
 <b>Counter Stool w/Arms</b> COM Yardage: 1 Freight Class: 250 Product Weight (lbs.): 26.50 Cubic Feet Per Carton: 10.75 (2 per carton)	Upholstered Seat and Back. Stacks 3 high on floor.	6667	548	574	595	627	670	684	724	796	831	899	989	1104
			<b>OVERALL DIMENSIONS</b> W D H			<b>SEAT DIMENSIONS</b> W D H			<b>BACK DIMENSIONS</b> W H					
			25.5	23.5	39.5	18	17.5	24	18	16				
			<div style="text-align: center;">RTA 00</div>											
 <b>Armless Counter Stool</b> COM Yardage: 1 Freight Class: 250 Product Weight (lbs.): 25.50 Cubic Feet Per Carton: 8.75 (2 per carton)	Upholstered Seat and Back. Stacks 3 high on floor.	6668	469	496	517	546	591	605	644	716	751	818	909	1024
			<b>OVERALL DIMENSIONS</b> W D H			<b>SEAT DIMENSIONS</b> W D H			<b>BACK DIMENSIONS</b> W H					
			20.75	23.5	39.5	18	17.5	24	18	16				
			<div style="text-align: center;">RTA 00</div>											
 <b>Seat Unit w/Arms</b> COM Yardage: N/A Freight Class: 250 Product Weight (lbs.): 19 Cubic Feet Per Carton: 4.88 (2 per carton)	Use with beams.	6690	297	-	-	-	-	-	-	-	-	-	-	
			<b>OVERALL DIMENSIONS</b> W D H			<b>SEAT DIMENSIONS</b> W D H			<b>BACK DIMENSIONS</b> W H					
			25.5	21	18	18	17.5	-	18	16				
			<div style="text-align: center;">RTA 00 </div>											

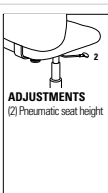
DESCRIPTION	FEATURES	MODEL#	STANDARD TEXTILE GRADES													
			1	2	3	4	5	6	7	8	9	10	11	12		
  <b>Armless Seat Unit</b> COM Yardage: N/A Freight Class: 150 Product Weight (lbs.): 18 Cubic Feet Per Carton: 3.25 (2 per carton)	Use with beams.	6691	218	-	-	-	-	-	-	-	-	-	-	-	-	
			OVERALL DIMENSIONS			SEAT DIMENSIONS			BACK DIMENSIONS							
			W	D	H	W	D	H	W	H						
			18	21	18	18	17.5	-	18	16						
			RTA 00		ups											
  <b>Seat Unit w/Arms</b> COM Yardage: 1 Freight Class: 250 Product Weight (lbs.): 19 Cubic Feet Per Carton: 4.88 (2 per carton)	Upholstered Seat. Use with beams.	6692	363	390	410	441	485	499	538	609	645	713	804	918		
			OVERALL DIMENSIONS			SEAT DIMENSIONS			BACK DIMENSIONS							
			W	D	H	W	D	H	W	H						
			25.5	21	18	18	17.5	-	18	15.5						
			RTA 00		ups											
  <b>Armless Seat Unit</b> COM Yardage: 1 Freight Class: 150 Product Weight (lbs.): 19 Cubic Feet Per Carton: 3.25 (2 per carton)	Upholstered Seat. Use with beams.	6693	282	307	327	359	402	417	455	527	563	630	721	835		
			OVERALL DIMENSIONS			SEAT DIMENSIONS			BACK DIMENSIONS							
			W	D	H	W	D	H	W	H						
			18	21	18	18	17.5	-	18	15.5						
			RTA 00		ups											
  <b>Seat Unit w/Arms</b> COM Yardage: 1 Freight Class: 150 Product Weight (lbs.): 20 Cubic Feet Per Carton: 4.88 (2 per carton)	Upholstered Seat and Back. Use with beams.	6697	385	410	430	462	504	520	558	630	666	733	824	938		
			OVERALL DIMENSIONS			SEAT DIMENSIONS			BACK DIMENSIONS							
			W	D	H	W	D	H	W	H						
			25.5	21	18	18	17	-	18	15.5						
			RTA 00		ups											
  <b>Armless Seat Unit</b> COM Yardage: 1 Freight Class: 150 Product Weight (lbs.): 19 Cubic Feet Per Carton: 3.25 (2 per carton)	Upholstered Seat and Back. Use with beams.	6698	314	339	360	391	434	449	488	560	595	663	753	868		
			OVERALL DIMENSIONS			SEAT DIMENSIONS			BACK DIMENSIONS							
			W	D	H	W	D	H	W	H						
			18	21	18	18	17	-	18	15.5						
			RTA 00		ups											

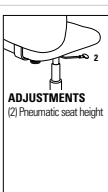
DESCRIPTION	FEATURES	MODEL#	STANDARD TEXTILE GRADES														
			1	2	3	4	5	6	7	8	9	10	11	12			
 <b>Task</b> COM Yardage: N/A Freight Class: 250 Product Weight (lbs.): 32 Cubic Feet Per Carton: 9.75	 <b>ADJUSTMENTS</b> (2) Pneumatic seat height	6720	1	2	3	4	5	6	7	8	9	10	11	12			
			427	-	-	-	-	-	-	-	-	-	-	-	-		
			OVERALL DIMENSIONS			SEAT DIMENSIONS			BACK DIMENSIONS								
			W	D	H	W	D	H	W	H							
			25.5	21.5	32.5	18	17.5	14-19	18	16							
		Ergonomic Features: C, M	<b>RTA 1</b>														
 <b>Task w/Arms and Tablet</b> COM Yardage: N/A Freight Class: 250 Product Weight (lbs.): 32 Cubic Feet Per Carton: 9.75	 <b>ADJUSTMENTS</b> (2) Pneumatic seat height	6720TR 6720TL	1	2	3	4	5	6	7	8	9	10	11	12			
			737	-	-	-	-	-	-	-	-	-	-	-	-		
			OVERALL DIMENSIONS			SEAT DIMENSIONS			BACK DIMENSIONS								
			W	D	H	W	D	H	W	H							
			25.5	21.5	32.5	18	17.5	14-19	18	16							
		Ergonomic Features: C, M	<b>RTA 1</b>														
 <b>Task Armless</b> COM Yardage: N/A Freight Class: 250 Product Weight (lbs.): 31 Cubic Feet Per Carton: 9.75	 <b>ADJUSTMENTS</b> (2) Pneumatic seat height	6721	1	2	3	4	5	6	7	8	9	10	11	12			
			328	-	-	-	-	-	-	-	-	-	-	-	-		
			OVERALL DIMENSIONS			SEAT DIMENSIONS			BACK DIMENSIONS								
			W	D	H	W	D	H	W	H							
			18.	21.5	32.5	18	17.5	14-19	18	16							
		Ergonomic Features: C, M	<b>RTA 1</b>														
 <b>Task Armless w/Tablet</b> COM Yardage: N/A Freight Class: 250 Product Weight (lbs.): 31 Cubic Feet Per Carton: 9.75	 <b>ADJUSTMENTS</b> (2) Pneumatic seat height	6721TR 6721TL	1	2	3	4	5	6	7	8	9	10	11	12			
			625	-	-	-	-	-	-	-	-	-	-	-	-		
			OVERALL DIMENSIONS			SEAT DIMENSIONS			BACK DIMENSIONS								
			W	D	H	W	D	H	W	H							
			18.	21.5	32.5	18	17.5	14-19	18	16							
		Ergonomic Features: C, M	<b>RTA 1</b>														
 <b>Task w/Arms</b> COM Yardage: 1 Freight Class: 250 Product Weight (lbs.): 33 Cubic Feet Per Carton: 9.75	 <b>ADJUSTMENTS</b> (2) Pneumatic seat height	6722	1	2	3	4	5	6	7	8	9	10	11	12			
			470	497	518	548	591	607	644	717	752	818	910	1025			
			OVERALL DIMENSIONS			SEAT DIMENSIONS			BACK DIMENSIONS								
			W	D	H	W	D	H	W	H							
			25.5	21.5	41	18	17.5	14.5-19.5	18	15.5							
		Ergonomic Features: C, M	<b>RTA 1</b>														

DESCRIPTION	FEATURES	MODEL#	STANDARD TEXTILE GRADES													
			1	2	3	4	5	6	7	8	9	10	11	12		
 <p><b>Task w/Arms and Tablet</b> COM Yardage: 1 Freight Class: 250 Product Weight (lbs.): 33 Cubic Feet Per Carton: 9.75</p>	 <p><b>ADJUSTMENTS</b> (2) Pneumatic seat height</p>	<p>6722TR 6722TL</p>	768	786	799	821	850	865	891	935	969	1005	1081	1161		
			<b>OVERALL DIMENSIONS</b>			<b>SEAT DIMENSIONS</b>			<b>BACK DIMENSIONS</b>							
			<b>W</b>	<b>D</b>	<b>H</b>	<b>W</b>	<b>D</b>	<b>H</b>	<b>W</b>	<b>H</b>						
			25.5	21.5	41	18	17.5	14.5-19.5	18	15.5						
			<b>RTA 1</b>													
 <p><b>Task Armless</b> COM Yardage: 1 Freight Class: 250 Product Weight (lbs.): 27 Cubic Feet Per Carton: 9.75</p>	 <p><b>ADJUSTMENTS</b> (2) Pneumatic seat height</p>	<p>6723</p>	372	398	419	450	492	508	545	618	654	720	812	925		
			<b>OVERALL DIMENSIONS</b>			<b>SEAT DIMENSIONS</b>			<b>BACK DIMENSIONS</b>							
			<b>W</b>	<b>D</b>	<b>H</b>	<b>W</b>	<b>D</b>	<b>H</b>	<b>W</b>	<b>H</b>						
			18	21.5	32.5	18	17	14.5-19.5	18	15.5						
			<b>RTA 1</b>													
 <p><b>Task Armless w/Tablet</b> COM Yardage: 1 Freight Class: 250 Product Weight (lbs.): 27 Cubic Feet Per Carton: 9.75</p>	 <p><b>ADJUSTMENTS</b> (2) Pneumatic seat height</p>	<p>6723TR 6723TL</p>	655	672	685	705	734	748	773	814	846	881	953	1030		
			<b>OVERALL DIMENSIONS</b>			<b>SEAT DIMENSIONS</b>			<b>BACK DIMENSIONS</b>							
			<b>W</b>	<b>D</b>	<b>H</b>	<b>W</b>	<b>D</b>	<b>H</b>	<b>W</b>	<b>H</b>						
			18	21.5	32.5	18	17	14.5-19.5	18	15.5						
			<b>RTA 1</b>													
 <p><b>Task w/Arms</b> COM Yardage: 1 Freight Class: 250 Product Weight (lbs.): 34 Cubic Feet Per Carton: 9.75</p>	 <p><b>ADJUSTMENTS</b> (2) Pneumatic seat height</p>	<p>6727</p>	536	562	582	613	656	672	709	782	817	884	976	1089		
			<b>OVERALL DIMENSIONS</b>			<b>SEAT DIMENSIONS</b>			<b>BACK DIMENSIONS</b>							
			<b>W</b>	<b>D</b>	<b>H</b>	<b>W</b>	<b>D</b>	<b>H</b>	<b>W</b>	<b>H</b>						
			25.5	21.5	32.5	18	17	14.5-19.5	18	16						
			<b>RTA 1</b>													
 <p><b>Task w/Arms w/Tablet</b> COM Yardage: 1 Freight Class: 250 Product Weight (lbs.): 34 Cubic Feet Per Carton: 9.75</p>	 <p><b>ADJUSTMENTS</b> (2) Pneumatic seat height</p>	<p>6727TR 6727TL</p>	862	881	897	919	952	968	998	1045	1081	1122	1206	1295		
			<b>OVERALL DIMENSIONS</b>			<b>SEAT DIMENSIONS</b>			<b>BACK DIMENSIONS</b>							
			<b>W</b>	<b>D</b>	<b>H</b>	<b>W</b>	<b>D</b>	<b>H</b>	<b>W</b>	<b>H</b>						
			25.5	21.5	32.5	18	17	14.5-19.5	18	16						
			<b>RTA 1</b>													

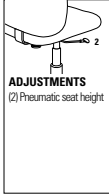
DESCRIPTION	FEATURES	MODEL#	STANDARD TEXTILE GRADES														
			1	2	3	4	5	6	7	8	9	10	11	12			
 <p><b>Task Armless</b> COM Yardage: 1 Freight Class: 250 Product Weight (lbs.): 33 Cubic Feet Per Carton: 9.75</p>	 <p><b>ADJUSTMENTS</b> (2) Pneumatic seat height</p>	<p>Upholstered Seat and Back</p> <p>Ergonomic Features: C, M</p>	6728	437	464	485	515	558	574	611	684	719	786	878	991		
			<b>OVERALL DIMENSIONS</b>			<b>SEAT DIMENSIONS</b>			<b>BACK DIMENSIONS</b>								
			<b>W</b>	<b>D</b>	<b>H</b>	<b>W</b>	<b>D</b>	<b>H</b>	<b>W</b>	<b>H</b>							
			18	21.5	32.5	18	17	14.5-19.5	18	15.5							
			<p><b>RTA 1</b></p>														
 <p><b>Task Armless w/Tablet</b> COM Yardage: 1 Freight Class: 250 Product Weight (lbs.): 33 Cubic Feet Per Carton: 9.75</p>	 <p><b>ADJUSTMENTS</b> (2) Pneumatic seat height</p>	<p>Upholstered Seat and Back <b>Specify (L) left or (R) right tablet.</b></p> <p>Ergonomic Features: C, M</p>	6728TR 6728TL	755	775	789	812	844	860	888	935	971	1010	1091	1178		
			<b>OVERALL DIMENSIONS</b>			<b>SEAT DIMENSIONS</b>			<b>BACK DIMENSIONS</b>								
			<b>W</b>	<b>D</b>	<b>H</b>	<b>W</b>	<b>D</b>	<b>H</b>	<b>W</b>	<b>H</b>							
			18	21.5	32.5	18	17	14.5-19.5	18	15.5							
			<p><b>RTA 1</b></p>														
 <p><b>Drafting Stool w/Arms</b> COM Yardage: N/A Freight Class: 150 Product Weight (lbs.): 38 Cubic Feet Per Carton: 9.75</p>	 <p><b>ADJUSTMENTS</b> (2) Pneumatic seat height</p>	<p>Polypropylene Seat and Back</p> <p>Ergonomic Features: C, M</p>	6730	569	-	-	-	-	-	-	-	-	-	-	-		
			<b>OVERALL DIMENSIONS</b>			<b>SEAT DIMENSIONS</b>			<b>BACK DIMENSIONS</b>								
			<b>W</b>	<b>D</b>	<b>H</b>	<b>W</b>	<b>D</b>	<b>H</b>	<b>W</b>	<b>H</b>							
			25.5	21.5	41	18	17.5	21-31	18	16							
			<p><b>RTA 1</b></p>														
 <p><b>Drafting Stool - Armless</b> COM Yardage: N/A Freight Class: 250 Product Weight (lbs.): 37 Cubic Feet Per Carton: 9.75</p>	 <p><b>ADJUSTMENTS</b> (2) Pneumatic seat height</p>	<p>Polypropylene Seat and Back</p> <p>Ergonomic Features: C, M</p>	6731	503	-	-	-	-	-	-	-	-	-	-			
			<b>OVERALL DIMENSIONS</b>			<b>SEAT DIMENSIONS</b>			<b>BACK DIMENSIONS</b>								
			<b>W</b>	<b>D</b>	<b>H</b>	<b>W</b>	<b>D</b>	<b>H</b>	<b>W</b>	<b>H</b>							
			18	21.5	41	18	17.5	21.5-31.5	18	15.5							
			<p><b>RTA 1</b></p>														
 <p><b>Drafting Stool w/Arms</b> COM Yardage: 1 Freight Class: 150 Product Weight (lbs.): 39 Cubic Feet Per Carton: 9.75</p>	 <p><b>ADJUSTMENTS</b> (2) Pneumatic seat height</p>	<p>Upholstered Seat</p> <p>Ergonomic Features: C, M</p>	6732	634	662	682	713	755	772	809	882	917	983	1076	1189		
			<b>OVERALL DIMENSIONS</b>			<b>SEAT DIMENSIONS</b>			<b>BACK DIMENSIONS</b>								
			<b>W</b>	<b>D</b>	<b>H</b>	<b>W</b>	<b>D</b>	<b>H</b>	<b>W</b>	<b>H</b>							
			25.5	21.5	41	18	17.5	21.5-31.5	18	15.5							
			<p><b>RTA 1</b></p>														

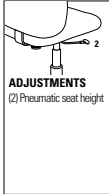
DESCRIPTION	FEATURES	MODEL#	STANDARD TEXTILE GRADES													
			1	2	3	4	5	6	7	8	9	10	11	12		
 <p><b>Drafting Stool - Armless</b> COM Yardage: 1 Freight Class: 150 Product Weight (lbs.): 38 Cubic Feet Per Carton: 9.75</p>	 <p><b>ADJUSTMENTS</b> (2) Pneumatic seat height</p> <p>Upholstered Seat</p> <p>Ergonomic Features: C, M</p>	<b>6733</b>	569	595	615	646	689	705	742	815	850	917	1009	1122		
		<b>OVERALL DIMENSIONS</b>			<b>SEAT DIMENSIONS</b>			<b>BACK DIMENSIONS</b>								
		<b>W</b>	<b>D</b>	<b>H</b>	<b>W</b>	<b>D</b>	<b>H</b>	<b>W</b>	<b>H</b>							
		18	21.5	41	18	17.5	21.5-31.5	18	15.5							
			<b>RTA 1</b>													
			1	2	3	4	5	6	7	8	9	10	11	12		
			<b>6737</b>	700	726	746	777	819	836	873	946	981	1048	1140	1254	
			<b>OVERALL DIMENSIONS</b>			<b>SEAT DIMENSIONS</b>			<b>BACK DIMENSIONS</b>							
			<b>W</b>	<b>D</b>	<b>H</b>	<b>W</b>	<b>D</b>	<b>H</b>	<b>W</b>	<b>H</b>						
			25.5	21.5	41	18	17	21.5-31.5	18	15.5						
			<b>RTA 1</b>													
 <p><b>Drafting Stool w/Arms</b> COM Yardage: 1 Freight Class: 150 Product Weight (lbs.): 40 Cubic Feet Per Carton: 9.75</p>	 <p><b>ADJUSTMENTS</b> (2) Pneumatic seat height</p> <p>Upholstered Seat and Back</p> <p>Ergonomic Features: C, M</p>	<b>6738</b>	634	661	681	712	754	771	808	881	916	982	1074	1189		
		<b>OVERALL DIMENSIONS</b>			<b>SEAT DIMENSIONS</b>			<b>BACK DIMENSIONS</b>								
		<b>W</b>	<b>D</b>	<b>H</b>	<b>W</b>	<b>D</b>	<b>H</b>	<b>W</b>	<b>H</b>							
		18	21.5	41	18	17	21.5-31.5	18	16.5							
			<b>RTA 1</b>													

FILE BUDDY™







model 1105

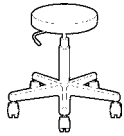

model 1110 Shown with 25-400 Vertical File

STANDARD FEATURES

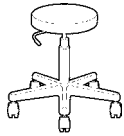
- Standard with C65 casters.
- Shipped R.T.A. (Ready to assemble).
- Not available in Leather.
- Pneumatic. Black, five-legged, injection molded base.
- 14" diameter seat.

DESCRIPTION	FEATURES	MODEL#	STANDARD TEXTILE GRADES												
			1	2	3	4	5	6	7	8	9	10	11	12	
 <p><b>Swivel Stool 5" Pneumatic, 20" Base</b>                      COM Yardage: .75                      Freight Class: 125                      Product Weight (lbs.): 11                      Cubic Feet Per Carton: 2.90</p>		<b>1105</b>	307	326	342	367	399	417	441	498	524	574	646	734	
			<b>OVERALL DIMENSIONS</b>			<b>SEAT DIMENSIONS</b>			<b>BACK DIMENSIONS</b>						
			<b>W</b>	<b>D</b>	<b>H</b>	<b>W</b>	<b>D</b>	<b>H</b>	<b>W</b>	<b>H</b>					
			14	14	18.5	14	-	16.5-21.5	-	-					
		<b>RTA 1</b>													
 <p><b>Swivel Stool 10" Pneumatic, 22" Base</b>                      COM Yardage: .75                      Freight Class: 125                      Product Weight (lbs.): 17                      Cubic Feet Per Carton: 2.90</p>		<b>1110</b>	359	375	393	418	450	467	490	546	573	625	697	785	
			<b>OVERALL DIMENSIONS</b>			<b>SEAT DIMENSIONS</b>			<b>BACK DIMENSIONS</b>						
			<b>W</b>	<b>D</b>	<b>H</b>	<b>W</b>	<b>D</b>	<b>H</b>	<b>W</b>	<b>H</b>					
			14	14	27.5	14	-	22.5-32.5	-	-					
		<b>RTA 1</b>													



**Features and Benefits**

- One-piece molded top and modesty are 0.5" thick polypropylene.
- Tables are rated 250 lbs. capacity.
- Surface includes factory installed metal inserts for solid and secure connection to the sled frame.
- 0.5" diameter solid steel rod sled frame.
- Bumpers on the underside for protection when stacking.
- Model with ADA width compliant frame is available.
- Shipped fully assembled.

Duet tables are multi-purpose stacking tables that offer optimum space utilization and flexibility. Their personality and simple design make them ideal for use in any learning or training environment at post-secondary and adult levels. Temporarily and easily convert auditoriums and other spaces into examination and seminar spaces. They can be partnered with stacking chairs such as Duet or Popcorn in matching or complementary colors (stacking chairs can be found in the Multi-Purpose section of the Seating price list).

The one-piece molded top and modesty are gently contoured providing an eased edge with an elegant waterfall transition from top to modesty.

Tops are available in a wide array of colors in 0.5" thick polypropylene. Polypropylene material offers strength and ease of cleaning with a slightly textured surface to offer scratch resistance.



One-piece top and modesty.



Stacks 5 high on floor or 20 high on dolly.

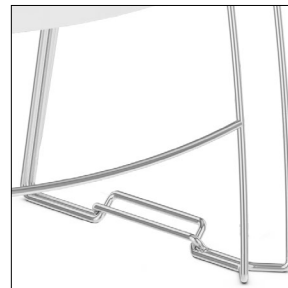

Ganging frame to keep tables evenly aligned.



**GENERAL INFORMATION**

- Duet tables are multi-purpose stacking tables ideal for auditoriums, seminars or any learning or training environment.
- Lightweight and easy to handle whether stacking for storage or setting up a room.
- Made of durable materials to withstand more demanding environments.
- Shipped fully assembled. Packaged 4 per carton.
- Global products are in compliance with stringent emission guidelines set out by the Greenguard Environmental Institute under the standards for low emitting products and materials. [www.greenguard.org](http://www.greenguard.org).
- Covered by Global's Lifetime Warranty.
- **Level 2 Certified.**

**WORKSURFACES**

- Top and modesty are a one-piece injection molded design in 0.5" thick polypropylene.
- Available in a wide array of colors (see right column "FINISHES") to complement any space or to define sections by color.
- One-piece molded top and modesty are contoured providing an eased user edge, with an elegant waterfall transition from top to modesty.

26"W x 18"D x 9.75"H

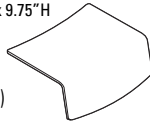

**CONSTRUCTION**

- Surface includes molded in threaded inserts to provide a secure metal-to-metal connection to the sled frame.
- Bumpers are included on the underside of top and inside modesty to protect surfaces when stacking.

**FRAME**

- 0.5" diameter solid steel rod sled frame.
- Available in a durable Chrome finish.
- Model with ganging frame keeps tables evenly positioned and aligned. No tools or fasteners required for ganging; the frames simply interlock.
- Model with ADA compliant frame is also available. The frame is 33" wide and the polypropylene top/modesty remain a constant size.
- Tables are standard without glides and are suitable for carpet, rubber or cork flooring.
- Glide options are available (see right column "GLIDES"). Glides must be chosen to best suit flooring type and site conditions. Upcharges apply.

**DOLLY**

- For space saving storage and transport.
- Constructed from 1.5" x 0.5" steel tubing with heavy duty casters (two locking) and a removable handle.
- Dolly can stack up to 20 tables.
- Stacking height on dolly is up to 68".

**Required specifications**

Top finish\*

**Optional specifications**

Glide option\*

**FINISHES**

<b>BZB</b>	Buzz Blue	<b>FRO</b>	Frost
<b>CCT</b>	Cactus	<b>INK</b>	Ink
<b>CRO</b>	Carrot	<b>LAB</b>	Latte
<b>IVC</b>	Cloud	<b>BLK</b>	Night
<b>DJN</b>	Dijon	<b>SND</b>	Sand
<b>EGP</b>	Eggplant	<b>SAR</b>	Scarlet
<b>FOG</b>	Fog	<b>SHW</b>	Shadow

**GLIDES**

<b>CG</b>	Clear polycarbonate (for carpet, rubber or concrete flooring). Height added to table: 0.18". Add \$12/set.
<b>SG</b>	Glides with stainless steel pads (for carpet or rubber flooring). Height added to table: 0.17". Add \$23/set.
<b>FG</b>	Glides with felt pads (for vinyl, cork or laminate flooring). Height added to table: 0.24". Add \$23/set.
<b>RG</b>	Glides with rubber pads (for vinyl, hardwood, laminate, stone or ceramic flooring). Height added to table: 0.16". Add \$23/set.

**SPECIFICATIONS**

- Specifications marked with an \* are applicable to only those products which have the\* symbol beside the product name.

**EXAMPLE DUET TABLE ORDER CODE:**

Duet stacking table, polypropylene surface in Shadow, clear polycarbonate glides

DTS1828P	-SHW	-CG
Model #	Surface finish	Glides

**STACKING TABLES**

**MODEL#      DIMENSIONS      FREIGHT CLASS      WT/LBS.      CUBIC FT.      LIST PRICE**

**D x W x H**

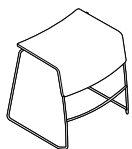

**Stacking Table\***

DTS1828P	25 x 29 x 28	150	26	17.75	359
----------	--------------	-----	----	-------	-----

One-piece polypropylene top and modesty with Chrome frame. Shipped fully assembled, 4 per carton.

- Price shown is per table. It is recommended to order in multiples of 4.
- Please be sure to select the appropriate glide (see previous page) for the flooring surface, as scratches could occur.
- Worksurface is 18”D x 28”W

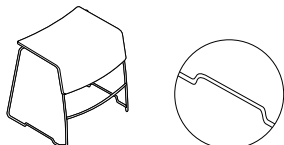

**Stacking Table, Ganging Frame\***

DTS1828PG	25 x 30.75 x 28	150	26	17.75	383
-----------	-----------------	-----	----	-------	-----

One-piece polypropylene top and modesty with Chrome ganging frame.

Shipped fully assembled, 4 per carton.

- Price shown is per table. It is recommended to order in multiples of 4.
- Please be sure to select the appropriate glide (see previous page) for the flooring surface, as scratches could occur.
- Worksurface is 18”D x 28”W

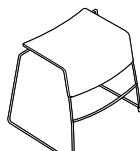

**Stacking Table, 32” Wide\***

DTA1832P	25 x 33 x 28	150	26	17.75	406
----------	--------------	-----	----	-------	-----

ADA (American with Disabilities Act) compliant. 33” wide. One-piece polypropylene top and modesty with Chrome frame. Underside clearance is 27.1”H (extra height if glides are selected). Stacks up to 5 high on floor only; dolly does not accommodate. Shipped fully assembled, 4 per carton.

- Price shown is per table. It is recommended to order in multiples of 4.
- Please be sure to select the appropriate glide (see previous page) for the flooring surface, as scratches could occur.
- Worksurface is 18”D x 32”W

**DOLLY**



**Dolly**

DTD20	29.5 x 63 x 38.5	250	50	21	523
-------	------------------	-----	----	----	-----

For use with tables DTS1828P and DTS1828PG. Can stack up to 20 tables. Black only. Removable handle for storage. Shipped fully assembled in 1 carton.

ISLANDS™



model 4075





model 4076

STANDARD FEATURES

- Islands offers wood guest seating with contemporary styling.
- Offered in two styles; Upholstered back pad or Horizontal wood slat.
- When upholstered in Leather, there are additional stitching details with a seam across the middle of the back and two seams on the seat.
- Does not stack.

OPTIONAL FEATURES

- Frame available in Absolute (AAM), Black (BKM), Cherry (ACM), Espresso Cafe (ECM), English Oak (EOM), Fruitwood (TFM), Gray (HGM), Honey (AHM), Mahogany (TMM), Maple (AVM), Medium Walnut (MWWM), Night (ASM), Shaker Cherry (SKM), Walnut (TWM), WC Cream (WTM), White (WHM) and Winter Cherry (WCM). Please Specify. Genuine maple faced veneers and solids are used.
- Offered in Fabric, Vinyl and Leather. Not available in Crescent fabric.

DESCRIPTION	FEATURES	MODEL#	STANDARD TEXTILE GRADES											
			1	2	3	4	5	6	7	8	9	10	11	12
 <p>4075</p> <p><b>Armchair</b> Upholstered back. COM Yardage: 1.50 Freight Class: 300 Product Weight (lbs.): 25 Cubic Feet Per Carton: 13.25</p>	<p>Does not stack.</p> <p>Ergonomic Features: M, N</p>	4075	707	746	777	822	887	918	977	1071	1143	1223	1389	1565
		4075LM	-	-	-	-	877	908	967	1060	1132	1213	1378	1554
			OVERALL DIMENSIONS			SEAT DIMENSIONS			BACK DIMENSIONS					
			W	D	H	W	D	H	W	H				
			24.5	23.5	32	20.5	18	18.5	19	13				
			RTA 00											
 <p>4076</p> <p><b>Armchair</b> Horizontal wood slat back. COM Yardage: 1 Freight Class: 300 Product Weight (lbs.): 25 Cubic Feet Per Carton: 13.25</p>	<p>Does not stack.</p> <p>Ergonomic Features: M, N</p>	4076	750	777	798	828	871	891	931	993	1041	1094	1205	1322
		4076L	-	-	-	-	-	-	-	980	1028	1082	1192	1310
			OVERALL DIMENSIONS			SEAT DIMENSIONS			BACK DIMENSIONS					
			W	D	H	W	D	H	W	H				
			24.5	23.5	32	20.5	18	18.5	19	13				
			RTA 00											

## LAYNE™



model 8520T







model 8525T

### STANDARD FEATURES

- Layne offers classic styling and value in a finely crafted wood framed side chair series.
- Frame construction is beechwood.
- Legs are equipped with White non-marking polypropylene glides. Suitable for both carpet and hard surface flooring.
- Offered in four back styles; Fully Upholstered, Picture Frame or Vertical Wood Slat.
- Offered in fabric, vinyl, leather or leather/mock leather combination.
- Does not stack.

### OPTIONAL FEATURES

- Wood frames are available in Absolute (AAM), Black (BKM), Cherry (ACM), Espresso Cafe (ECM), English Oak (EOM), Fruitwood (TFM), Gray (HGM), Honey (AHM), Mahogany (TMM), Maple (AVM), Medium Walnut (MWM), Night (ASM), Shaker Cherry (SKM), Walnut (TWM), WC Cream (WTM), White (WHM) and Winter Cherry (WCM). Please Specify.

DESCRIPTION	FEATURES	MODEL#	STANDARD TEXTILE GRADES													
			1	2	3	4	5	6	7	8	9	10	11	12		
 <b>Armless Upholstered Side Chair</b> COM Yardage: 1.25 Freight Class: 300 Product Weight (lbs.): 18 Cubic Feet Per Carton: 16	Does not stack.  Ergonomic Features: M, N	<b>8520T</b>	634	666	691	727	779	798	844	931	972	1052	1161	1298		
		<b>OVERALL DIMENSIONS</b>			<b>SEAT DIMENSIONS</b>			<b>BACK DIMENSIONS</b>								
		<b>W</b>	<b>D</b>	<b>H</b>	<b>W</b>	<b>D</b>	<b>H</b>	<b>W</b>	<b>H</b>							
		22.5	23	33	20	18.25	18	17.5	14							
			<b>RTA 00</b>													
 <b>Fully Upholstered Armchair</b> COM Yardage: 2.25 Freight Class: 300 Product Weight (lbs.): 20 Cubic Feet Per Carton: 16	Does not stack  Ergonomic Features: M, N	<b>8521T</b>	683	720	750	794	855	879	934	1037	1087	1183	1315	1479		
		<b>OVERALL DIMENSIONS</b>			<b>SEAT DIMENSIONS</b>			<b>BACK DIMENSIONS</b>								
		<b>W</b>	<b>D</b>	<b>H</b>	<b>W</b>	<b>D</b>	<b>H</b>	<b>W</b>	<b>H</b>							
		22.5	23	33	20	18.25	18	17.5	14							
			<b>RTA 00</b>													
 <b>Picture Frame Armchair</b> COM Yardage: 1.25 Freight Class: 300 Product Weight (lbs.): 20 Cubic Feet Per Carton: 16	Does not stack  Ergonomic Features: M, N	<b>8522T</b>	765	791	810	840	881	896	933	1001	1035	1100	1187	1296		
		<b>OVERALL DIMENSIONS</b>			<b>SEAT DIMENSIONS</b>			<b>BACK DIMENSIONS</b>								
		<b>W</b>	<b>D</b>	<b>H</b>	<b>W</b>	<b>D</b>	<b>H</b>	<b>W</b>	<b>H</b>							
		22.5	23	33	20	18.25	18	17.5	14							
			<b>RTA 00</b>													
 <b>Upholstered Armchair</b> COM Yardage: 1.25 Freight Class: 300 Product Weight (lbs.): 18 Cubic Feet Per Carton: 16	Does not stack  Ergonomic Features: M, N	<b>8525T</b>	721	754	779	817	872	891	939	1029	1073	1157	1272	1414		
		<b>OVERALL DIMENSIONS</b>			<b>SEAT DIMENSIONS</b>			<b>BACK DIMENSIONS</b>								
		<b>W</b>	<b>D</b>	<b>H</b>	<b>W</b>	<b>D</b>	<b>H</b>	<b>W</b>	<b>H</b>							
		22.5	23	33	20	18.25	18	17.5	14							
			<b>RTA 00</b>													

DESCRIPTION	FEATURES	MODEL#	STANDARD TEXTILE GRADES													
			1	2	3	4	5	6	7	8	9	10	11	12		
 <p><b>Vertical Wood Slat Armchair</b>                      COM Yardage: 1                      Freight Class: 300                      Product Weight (lbs.): 18                      Cubic Feet Per Carton: 16</p>	Does not stack.  Ergonomic Features: M, N	<b>8526T</b>	749	769	784	806	836	848	876	926	952	1000	1066	1147		
			OVERALL DIMENSIONS			SEAT DIMENSIONS			BACK DIMENSIONS							
			W	D	H	W	D	H	W	H						
			21	23	33	20	18.25	18	17.5	14						
			<b>RTA 00</b>													

## LITE



model 5940



model 5944



Closed Loop Arms.



model 5945



model 5951C

### STANDARD FEATURES

- Lite is a modern series inspired by classic designs.
- Arms are standard in cantilevered or closed loop. Both are made from fiberglass reinforced nylon, available in Black only.
- Frame is heavy duty, equipped with Sytex™ high-strength polyester webbing suspension system for extra comfort.
- Cantilever frame models are 1" diameter 12 gauge tubular steel.
- Four legged frames are 1" diameter 12 gauge tubular steel front legs and 7/8" diameter 14 gauge tubular steel rear legs, depending on the model.
- Glides are non-marking polypropylene (NM) suitable for both carpet and hard surface flooring.
- All models are rated for active user load of 300 lbs. per seat.
- Dual wheel carpet casters (C82) are standard on caster models.
- Metal frames are standard in Black (BLK).
- Upholstery options (upholstered models): fabric, vinyl, leather or leather/mock leather combination.

### OPTIONAL FEATURES

- Mesh models are available in any of the 24 standard Vue Mesh colors. Seat and back will be the same color mesh. Specify color: Sandy Beach (VU10), Dessert Sand (VU11), Orange Sunset (VU12), Chocolate Fountain (VU13), Artic Blue (VU14), Quarry Grey (VU15), Tidal Wave (VU16), Ivy Moss (VU17), Red Rose (VU18), Black (VU19), White (VU20), Lime (VU21), Chartreuse (VU23), Pool Blue (VU26), Sky (VU28), Ice (VU30), Primary Blue (VU32), Tangerine (VU34), Paprika (VU37), Grain (VU40), Yellow (VU43), Silver Grey (VU55), Silver (VU63), Hot Pink (VU65) and Red Mittens (VU70)
- A selection of glide options is available for four-legged chairs (models 5940, 5941, 5942, 5950, 5951 and 5952). Glides must be chosen to best suit flooring type and site conditions.
- Glides with felt pads (FG) are available for vinyl sheet, cork or laminate flooring, please specify. Add \$42.
- Glides with rubber pads (RG) are available for vinyl, hardwood, laminate, stone or ceramic flooring, please specify. Add \$42.
- For hard floor surface flooring casters please specify C9R, add \$68.
- Optional Tungsten (TUN) epoxy finish. No upcharge.
- Optional Chrome (CHR) metal finish. Add \$72.



#### Four-legged Frame Armless

COM Yardage: N/A  
 Freight Class: 150  
 Product Weight (lbs.): 26  
 Cubic Feet Per Carton: 12.5

Does not stack.

	1	2	3	4	5	6	7	8	9	10	11	12
5940	561											

OVERALL DIMENSIONS			SEAT DIMENSIONS			BACK DIMENSIONS	
W	D	H	W	D	H	W	H
21.75	24.75	34.25	20	17	19	16	19

RTA 00



#### Four-legged Frame Armless w/Casters

COM Yardage: N/A  
 Freight Class: 150  
 Product Weight (lbs.): 26

Does not stack.

Cubic Feet Per Carton: 12.5

	1	2	3	4	5	6	7	8	9	10	11	12
5940C	650											

OVERALL DIMENSIONS			SEAT DIMENSIONS			BACK DIMENSIONS	
W	D	H	W	D	H	W	H
21.75	24.75	34.25	20	17	19	16	19

RTA 00



#### Four-legged Frame w/Cantilever Arms





COM Yardage: N/A  
 Freight Class: 150  
 Product Weight (lbs.): 29  
 Cubic Feet Per Carton: 13.75





Does not stack.

	1	2	3	4	5	6	7	8	9	10	11	12
5941	645											





OVERALL DIMENSIONS			SEAT DIMENSIONS			BACK DIMENSIONS	
W	D	H	W	D	H	W	H
24	25.5	34.25	20	17	19	16	19

RTA 00

DESCRIPTION	FEATURES	MODEL#	STANDARD TEXTILE GRADES													
			1	2	3	4	5	6	7	8	9	10	11	12		
 <p><b>Four-legged Frame w/Cantilever Arms &amp; Casters</b> COM Yardage: N/A Freight Class: 150 Product Weight (lbs.): 29 Cubic Feet Per Carton: 13.75</p>	Does not stack.	5941C	734													
			<b>OVERALL DIMENSIONS</b>			<b>SEAT DIMENSIONS</b>			<b>BACK DIMENSIONS</b>							
			<b>W</b>	<b>D</b>	<b>H</b>	<b>W</b>	<b>D</b>	<b>H</b>	<b>W</b>	<b>H</b>						
			24	25.5	34.25	20	17	19	16	19						
			<b>RTA 00</b>													
 <p><b>Four-legged Frame w/ Loop Arms</b> COM Yardage: N/A Freight Class: 150 Product Weight (lbs.): 29 Cubic Feet Per Carton: 13.75</p>	Does not stack.	5942	645													
			<b>OVERALL DIMENSIONS</b>			<b>SEAT DIMENSIONS</b>			<b>BACK DIMENSIONS</b>							
			<b>W</b>	<b>D</b>	<b>H</b>	<b>W</b>	<b>D</b>	<b>H</b>	<b>W</b>	<b>H</b>						
			23.75	25.5	34.25	20	17	19	16	19						
			<b>RTA 00</b>													
 <p><b>Four-legged Frame w/ Loop Arms &amp; Casters</b> COM Yardage: N/A Freight Class: 150 Product Weight (lbs.): 29 Cubic Feet Per Carton: 13.75</p>	Does not stack.	5942C	734													
			<b>OVERALL DIMENSIONS</b>			<b>SEAT DIMENSIONS</b>			<b>BACK DIMENSIONS</b>							
			<b>W</b>	<b>D</b>	<b>H</b>	<b>W</b>	<b>D</b>	<b>H</b>	<b>W</b>	<b>H</b>						
			23.75	25.5	34.25	20	17	19	16	19						
			<b>RTA 00</b>													
 <p><b>Cantilever Frame Armless</b> COM Yardage: N/A Freight Class: 150 Product Weight (lbs.): 27 Cubic Feet Per Carton: 12.5</p>	Does not stack.	5943	608													
			<b>OVERALL DIMENSIONS</b>			<b>SEAT DIMENSIONS</b>			<b>BACK DIMENSIONS</b>							
			<b>W</b>	<b>D</b>	<b>H</b>	<b>W</b>	<b>D</b>	<b>H</b>	<b>W</b>	<b>H</b>						
			21.75	23.5	34.25	20	17	19	16	19						
			<b>RTA 00</b>													
 <p><b>Cantilever Frame w/Cantilever Arms</b> COM Yardage: N/A Freight Class: 150 Product Weight (lbs.): 35 Cubic Feet Per Carton: 13.75</p>	Does not stack.	5944	692													
			<b>OVERALL DIMENSIONS</b>			<b>SEAT DIMENSIONS</b>			<b>BACK DIMENSIONS</b>							
			<b>W</b>	<b>D</b>	<b>H</b>	<b>W</b>	<b>D</b>	<b>H</b>	<b>W</b>	<b>H</b>						
			24	23.5	34.25	20	17	19	16	19						
			<b>RTA 00</b>													

DESCRIPTION	FEATURES	MODEL#	STANDARD TEXTILE GRADES															
			1	2	3	4	5	6	7	8	9	10	11	12				
 <p><b>Cantilever Frame w/Loop Arms</b> COM Yardage: N/A Freight Class: 150 Product Weight (lbs.): 35 Cubic Feet Per Carton: 13.75</p>	Does not stack.	5945	692															
		<b>OVERALL DIMENSIONS</b>			<b>SEAT DIMENSIONS</b>			<b>BACK DIMENSIONS</b>										
		<b>W</b>	<b>D</b>	<b>H</b>	<b>W</b>	<b>D</b>	<b>H</b>	<b>W</b>	<b>H</b>									
		23.75	23.5	34.25	20	17	19	16	19									
		<b>RTA 00</b>																
 <p><b>Upholstered Four-legged Frame Armless</b> COM Yardage: 1.50 Freight Class: 150 Product Weight (lbs.): 26 Cubic Feet Per Carton: 12.5</p>	Does not stack.	5950	464	506	539	590	661	694	758	861	939	1026	1208	1399				
		5950LM	-	-	-	-	661	-	-	861	939	1026	1208	1399				
		<b>OVERALL DIMENSIONS</b>			<b>SEAT DIMENSIONS</b>			<b>BACK DIMENSIONS</b>										
		<b>W</b>	<b>D</b>	<b>H</b>	<b>W</b>	<b>D</b>	<b>H</b>	<b>W</b>	<b>H</b>									
		21.75	24.75	34.25	20	17	19	16	19									
<b>RTA 00</b>																		
 <p><b>Upholstered Four-legged Frame Armless w/Casters</b> COM Yardage: 1.50 Freight Class: 150 Product Weight (lbs.): 26 Cubic Feet Per Carton: 12.5</p>	Does not stack.	5950C	553	595	628	678	749	781	846	949	1027	1115	1296	1362				
		5950CLM	-	-	-	-	749	-	-	949	1027	1115	1296	1488				
		<b>OVERALL DIMENSIONS</b>			<b>SEAT DIMENSIONS</b>			<b>BACK DIMENSIONS</b>										
		<b>W</b>	<b>D</b>	<b>H</b>	<b>W</b>	<b>D</b>	<b>H</b>	<b>W</b>	<b>H</b>									
		21.75	24.75	34.25	20	17	19	16	19									
<b>RTA 00</b>																		
 <p><b>Upholstered Four-legged Frame w/Cantilever Arms</b> COM Yardage: 1.50 Freight Class: 150 Product Weight (lbs.): 29 Cubic Feet Per Carton: 13.75</p>	Does not stack.	5951	546	590	623	672	743	776	841	943	1022	1109	1290	1357				
		5951LM	-	-	-	-	743	-	-	943	1022	1109	1290	1483				
		<b>OVERALL DIMENSIONS</b>			<b>SEAT DIMENSIONS</b>			<b>BACK DIMENSIONS</b>										
		<b>W</b>	<b>D</b>	<b>H</b>	<b>W</b>	<b>D</b>	<b>H</b>	<b>W</b>	<b>H</b>									
		24	25.5	34.25	20	17	19	16	19									
<b>RTA 00</b>																		
 <p><b>Upholstered Four-legged Frame w/Cantilever Arms &amp; Casters</b> COM Yardage: 1.50 Freight Class: 150 Product Weight (lbs.): 29 Cubic Feet Per Carton: 13.75</p>	Does not stack.	5951C	636	679	712	762	833	866	931	1033	1112	1198	1380	1439				
		5951CLM	-	-	-	-	833	-	-	1033	1112	1198	1380	1572				
		<b>OVERALL DIMENSIONS</b>			<b>SEAT DIMENSIONS</b>			<b>BACK DIMENSIONS</b>										
		<b>W</b>	<b>D</b>	<b>H</b>	<b>W</b>	<b>D</b>	<b>H</b>	<b>W</b>	<b>H</b>									
		24	25.5	34.25	20	17	19	16	19									
<b>RTA 00</b>																		



DESCRIPTION	FEATURES	MODEL#	STANDARD TEXTILE GRADES													
			1	2	3	4	5	6	7	8	9	10	11	12		
<b>Upholstered Four-legged Frame w/Loop Arms</b> COM Yardage: 1.50 Freight Class: 150 Product Weight (lbs.): 29 Cubic Feet Per Carton: 13.75	Does not stack.		1	2	3	4	5	6	7	8	9	10	11	12		
		5952	546	590	623	672	743	776	841	943	1022	1109	1290	1357		
		5952LM	-	-	-	-	743	-	-	943	1022	1109	1290	1483		
		<b>OVERALL DIMENSIONS</b>	<b>W</b>	<b>D</b>	<b>H</b>	<b>SEAT DIMENSIONS</b>			<b>BACK DIMENSIONS</b>			<b>W</b>	<b>H</b>			
		23.75	25.5	34.25	20	17	19	16	19							
		<b>RTA 00</b>														
		 <b>Upholstered Four-legged Frame w/Loop Arms &amp; Casters</b> COM Yardage: 1.50 Freight Class: 150 Product Weight (lbs.): 29 Cubic Feet Per Carton: 13.75	Does not stack.		1	2	3	4	5	6	7	8	9	10	11	12
				5952C	636	679	712	762	833	866	931	1033	1112	1198	1380	1439
				5952CLM	-	-	-	-	833	-	-	1033	1112	1198	1380	1572
				<b>OVERALL DIMENSIONS</b>	<b>W</b>	<b>D</b>	<b>H</b>	<b>SEAT DIMENSIONS</b>			<b>BACK DIMENSIONS</b>			<b>W</b>	<b>H</b>	
23.75	25.5			34.25	20	17	19	16	19							
<b>RTA 00</b>																
 <b>Upholstered Cantilever Frame Armless</b> COM Yardage: 1.50 Freight Class: 150 Product Weight (lbs.): 27 Cubic Feet Per Carton: 12.5	Does not stack.				1	2	3	4	5	6	7	8	9	10	11	12
				5953	509	553	586	635	706	739	804	906	985	1072	1253	1323
				5953LM	-	-	-	-	706	-	-	906	985	1072	1253	1446
				<b>OVERALL DIMENSIONS</b>	<b>W</b>	<b>D</b>	<b>H</b>	<b>SEAT DIMENSIONS</b>			<b>BACK DIMENSIONS</b>			<b>W</b>	<b>H</b>	
		21.75	23.5	34.25	20	17	19	16	19							
		<b>RTA 00</b>														
		 <b>Upholstered Cantilever Frame w/Cantilever Arms</b> COM Yardage: 1.50 Freight Class: 150 Product Weight (lbs.): 35 Cubic Feet Per Carton: 13.75	Does not stack.		1	2	3	4	5	6	7	8	9	10	11	12
				5954	594	636	669	719	791	823	887	990	1069	1156	1337	1529
				5954LM	-	-	-	-	791	-	-	990	1069	1156	1337	1400
				<b>OVERALL DIMENSIONS</b>	<b>W</b>	<b>D</b>	<b>H</b>	<b>SEAT DIMENSIONS</b>			<b>BACK DIMENSIONS</b>			<b>W</b>	<b>H</b>	
24	23.5			34.25	20	17	19	16	19							
<b>RTA 00</b>																
 <b>Upholstered Cantilever Frame w/Loop Arms</b> COM Yardage: 1.50 Freight Class: 150 Product Weight (lbs.): 35 Cubic Feet Per Carton: 13.75	Does not stack.				1	2	3	4	5	6	7	8	9	10	11	12
				5955	594	636	669	719	791	823	887	990	1069	1156	1337	1400
				5955LM	-	-	-	-	791	-	-	990	1069	1156	1337	1529
				<b>OVERALL DIMENSIONS</b>	<b>W</b>	<b>D</b>	<b>H</b>	<b>SEAT DIMENSIONS</b>			<b>BACK DIMENSIONS</b>			<b>W</b>	<b>H</b>	
		23.75	23.5	34.25	20	17	19	16	19							
		<b>RTA 00</b>														

MARCHE™



model 8624 (BCH)

model 8621 (CH)



**Side Chair** Open wood back  
COM Yardage: .1  
Freight Class: 250  
Product Weight (lbs.): 43  
Cubic Feet Per Carton: 15

Does not stack.



**Side Chair** Closed Upholstered Wood back  
COM Yardage: 2.25  
Freight Class: 250  
Product Weight (lbs.): 43  
Cubic Feet Per Carton: 15.73

Does not stack.



**Side Chair** Closed Wood Back  
COM Yardage: .75  
Freight Class: 250  
Product Weight (lbs.): 43  
Cubic Feet Per Carton: 15.73

Does not stack.



**Counter Stool** Open Wood Back  
COM Yardage: .75  
Freight Class: 250  
Product Weight (lbs.): 43  
Cubic Feet Per Carton: 21

Does not stack.

STANDARD FEATURES

- A contemporary wood seating series.
- Legs are standard in Black with Black non-marking glides.
- Does not stack.
- Upholstery options: fabric, vinyl, leather or leather/mock leather combination.

OPTIONAL FEATURES

- Wood backs are available in Absolute (AAM), Black (BKM), Cherry (ACM), English Oak (EOM), Espresso Cafe (ECM), Fruitwood (TFM), Gray (HGM), Honey

(AHM), Mahogany (TMM), Maple (AVM), Medium Walnut (MWM), Night (ASM), Shaker Cherry (SKM), Walnut (TWM), WC Cream (WTM), White (WHM) and Winter Cherry (WCM). Please Specify.

- Optional finishes are available at an upcharge. For models 8621, 8622 or 8624 add \$68 for Chrome (CH) or Brushed Chrome (BCH), Add \$46 for Tungsten (TUN).

For models 8621S, 8622S or 8624S add \$90 for Chrome (CH) or Brushed Chrome (BCH), Add \$64 for Tungsten (TUN).

	1	2	3	4	5	6	7	8	9	10	11	12
<b>8621</b>	829	888	904	925	957	969	995	1048	1072	1120	1187	1268

OVERALL DIMENSIONS			SEAT DIMENSIONS			BACK DIMENSIONS	
W	D	H	W	D	H	W	H
20	21	31.5	19	16.5	19	20	13.5

RTA 00

	1	2	3	4	5	6	7	8	9	10	11	12
<b>8622</b>	837	910	935	972	1024	1043	1088	1175	1216	1297	1406	1542

OVERALL DIMENSIONS			SEAT DIMENSIONS			BACK DIMENSIONS	
W	D	H	W	D	H	W	H
20	21	31.5	19	16.5	19	20	13.5

RTA 00

	1	2	3	4	5	6	7	8	9	10	11	12
<b>8624</b>	829	888	904	925	957	969	995	1048	1072	1120	1187	1268





OVERALL DIMENSIONS			SEAT DIMENSIONS			BACK DIMENSIONS	
W	D	H	W	D	H	W	H
20	21	31.5	19	16.5	19	20	13.5

RTA 00

	1	2	3	4	5	6	7	8	9	10	11	12
<b>8621S26</b>	1024	1046	1062	1087	1122	1139	1172	1223	1262	1306	1396	1492

OVERALL DIMENSIONS			SEAT DIMENSIONS			BACK DIMENSIONS	
W	D	H	W	D	H	W	H
21.5	21	39	19	16.5	26	20	13.5

RTA 00

DESCRIPTION	FEATURES	MODEL#	STANDARD TEXTILE GRADES												
			1	2	3	4	5	6	7	8	9	10	11	12	
 <p><b>Counter Stool</b> Closed Upholstered Wood Back COM Yardage: 1.25 Freight Class: 250 Product Weight (lbs.): 43 Cubic Feet Per Carton: 21</p>	Does not stack.	<b>8622S26</b>	1064	1100	1127	1170	1228	1255	1309	1395	1461	1534	1684	1844	
			<b>OVERALL DIMENSIONS</b>			<b>SEAT DIMENSIONS</b>			<b>BACK DIMENSIONS</b>						
			<b>W</b>	<b>D</b>	<b>H</b>	<b>W</b>	<b>D</b>	<b>H</b>	<b>W</b>	<b>H</b>					
			21.5	21	39	19	16.5	26	20	13.5					
			<b>RTA 00</b>												
 <p><b>Counter Stool</b> Closed Wood Back COM Yardage: .75 Freight Class: 250 Product Weight (lbs.): 43 Cubic Feet Per Carton: 21</p>	Does not stack.	<b>8624S26</b>	1024	1046	1062	1087	1122	1139	1172	1223	1262	1306	1396	1492	
			<b>OVERALL DIMENSIONS</b>			<b>SEAT DIMENSIONS</b>			<b>BACK DIMENSIONS</b>						
			<b>W</b>	<b>D</b>	<b>H</b>	<b>W</b>	<b>D</b>	<b>H</b>	<b>W</b>	<b>H</b>					
			21.5	21	39	19	16.5	26	20	13.5					
			<b>RTA 00</b>												
 <p><b>Barstool</b> Open Wood Back COM Yardage: .75 Freight Class: 250 Product Weight (lbs.): 43 Cubic Feet Per Carton: 21</p>	Does not stack.	<b>8621S30</b>	1079	1153	1166	1189	1221	1230	1258	1311	1335	1385	1450	1531	
			<b>OVERALL DIMENSIONS</b>			<b>SEAT DIMENSIONS</b>			<b>BACK DIMENSIONS</b>						
			<b>W</b>	<b>D</b>	<b>H</b>	<b>W</b>	<b>D</b>	<b>H</b>	<b>W</b>	<b>H</b>					
			21.5	21	43	19	16.5	30	20	13.5					
			<b>RTA 00</b>												
 <p><b>Barstool</b> Closed Upholstered Wood Back COM Yardage: 1.25 Freight Class: 250 Product Weight (lbs.): 43 Cubic Feet Per Carton: 21</p>	Does not stack.	<b>8622S30</b>	1120	1208	1231	1269	1321	1339	1386	1471	1514	1594	1703	1840	
			<b>OVERALL DIMENSIONS</b>			<b>SEAT DIMENSIONS</b>			<b>BACK DIMENSIONS</b>						
			<b>W</b>	<b>D</b>	<b>H</b>	<b>W</b>	<b>D</b>	<b>H</b>	<b>W</b>	<b>H</b>					
			21.5	21	43	19	16.5	30	20	13.5					
			<b>RTA 00</b>												
 <p><b>Barstool</b> Closed Wood Back COM Yardage: .75 Freight Class: 250 Product Weight (lbs.): 43 Cubic Feet Per Carton: 21</p>	Does not stack.	<b>8624S30</b>	1079	1153	1166	1189	1221	1230	1258	1311	1335	1385	1450	1531	
			<b>OVERALL DIMENSIONS</b>			<b>SEAT DIMENSIONS</b>			<b>BACK DIMENSIONS</b>						
			<b>W</b>	<b>D</b>	<b>H</b>	<b>W</b>	<b>D</b>	<b>H</b>	<b>W</b>	<b>H</b>					
			21.5	21	43	19	16.5	30	20	13.5					
			<b>RTA 00</b>												

MAYNE™



model 8335T



model 8336T

STANDARD FEATURES

- Mayne offers classic styling and value in a finely crafted wood framed side chair.
- Frame construction is beechwood.
- Legs are equipped with White non-marking polypropylene glides Suitable for both carpet and hard surface flooring.
- Offered in two back styles; Upholstered back or Vertical wood slat.
- Offered in Fabric, Vinyl and Leather.
- Does not stack.

OPTIONAL FEATURES

- Wood frames available in Absolute (AAM), Black (BKM), Cherry (ACM), Espresso Cafe (ECM), English Oak (EOM), Fruitwood (TFM), Gray (HGM), Honey (AHM), Mahogany (TMM), Maple (AVM), Medium Walnut (MWM), Night (ASM), Shaker Cherry (SKM), Walnut (TWM), WC Cream (WTM), White (WHM) and Winter Cherry (WCM). Please Specify..



**Upholstered Armchair**

COM Yardage: 1.25  
 Freight Class: 300  
 Product Weight (lbs.): 21  
 Cubic Feet Per Carton: 16

Does not stack.

Ergonomic Features:  
 M, N

	1	2	3	4	5	6	7	8	9	10	11	12
<b>8335T</b>	765	796	821	857	909	927	974	1060	1102	1182	1291	1428

OVERALL DIMENSIONS			SEAT DIMENSIONS			BACK DIMENSIONS	
W	D	H	W	D	H	W	H
23	24	33	20	18.25	18	17.5	14

RTA 00



**Vertical Wood Slat Armchair**

COM Yardage: 1  
 Freight Class: 300  
 Product Weight (lbs.): 19  
 Cubic Feet Per Carton: 16

Does not stack.

Ergonomic Features:  
 M, N

	1	2	3	4	5	6	7	8	9	10	11	12
<b>8336T</b>	793	812	828	849	880	891	919	971	995	1044	1109	1191

OVERALL DIMENSIONS			SEAT DIMENSIONS			BACK DIMENSIONS	
W	D	H	W	D	H	W	H
23	24	33	20	18.25	18	17.5	14

RTA 00

MODA™



model 6960



model 6961

Also see Moda Stacking Chairs



For Moda stacking chairs, please see page 187.

STANDARD FEATURES

- Moda is an upscale, classic looking multi-purpose product, ideal for conference rooms, training, break out and collaboration areas as well as light-use tasking.
- Chairs are molded with a one-piece shell. Available in Night (**BLK**), Cloud (**IVC**) or Shadow (**SHW**).
- Chair frame consists of a Polished Aluminum chassis on four steel legs in a durable Chrome finish.
- Standard with nylon glides (**N1**), suitable for carpet, rubber or concrete flooring.
- Upholstery options: fabric, vinyl or leather. Not available in leather/mock leather combination.
- Four legged chairs do not stack.

OPTIONAL FEATURES

- All models are available with optional armcaps in Black self-skinned urethane (SSU), or in Black, White or Clear Grey finish hard plastic.
- Model 6961 armcaps can also be upholstered in the matching fabric, vinyl or leather.
- Glides with felt pads (**FG**) are available for vinyl sheet, cork or laminate flooring, please specify. Add \$26.
- Glides with felt pads (**RG**) are available for vinyl sheet, hardwood, laminate, stone or ceramic flooring, please specify. Add \$26.
- Adjustable swivel glides (**SWG**) are available for uneven floors, please specify. No upcharge



OPTION CODES

Please add option codes in the following order:

- **Model number**  
**6960** Armchair  
**6961** Armchair w/upholstered seat
- **Textile**  
Specify textile code for seat (model 6961 only).
- **Shell color** (no upcharge)  
**(BLK)** Night  
**(IVC)** Cloud  
**(SHW)** Shadow
- **Frame finish**  
**(CH)** Chrome. No upcharge.  
**(BK)** Black. Add \$62.  
**(TN)** Tungsten. Add \$62.  
**(BT)** Butternut woodgrain. Add \$129.  
**(EB)** Ebony woodgrain. Add \$129.  
**(WU)** Walnut woodgrain. Add \$129.
- **Armcaps**  
**(NC)** No armcaps.  
**(SS)** Black SSU. Add \$47.  
**(GC)** Clear Grey hard plastic. Add \$26.  
**(H3)** Black hard plastic. Add \$26.  
**(H4)** White hard plastic. Add \$26.  
**Armcaps** (to match woodgrain frame finish only)  
**(BT)** Butternut woodgrain. Add \$88.  
**(EB)** Ebony woodgrain. Add \$88.  
**(WU)** Walnut woodgrain. Add \$88.  
**Armcaps** (upholstered model 6961 only)  
**(UP)** Matching upholstery. Add \$52.
- **Glide style** (no upcharge)  
**(FX)** Fixed glide (STD)  
**(SWG)** Adjustable swivel..
- **Glide type**  
**(N1)** Standard nylon. No upcharge.  
**(FG)** Felt. Add \$26.  
**(RG)** Rubber. Add \$26.

EXAMPLE MODA ORDER CODE:

6960	-HD05	-IVC	-CH	-NC	-FX	-N1
Model #	Textile	Shell	Frame	Armcaps	Glide style	Glide type

DESCRIPTION	FEATURES	MODEL #	STANDARD TEXTILE GRADES													
			1	2	3	4	5	6	7	8	9	10	11	12		
 <p><b>Four-Legged Armchair</b>                      COM Yardage: N/A                      Freight Class: 300                      Product Weight (lbs.): 16                      Cubic Feet Per Carton: 14.5</p>	Polypropylene seat & back.	6960	567													
					<b>OVERALL DIMENSIONS</b> W D H			<b>SEAT DIMENSIONS</b> W D H			<b>BACK DIMENSIONS</b> W H					
		25	25	31	20.5	18	15.5	20	16							
					<b>RTA 1</b>			1 per carton								
 <p><b>Four-Legged Armchair</b>                      COM Yardage: 0.75                      Freight Class: 300                      Product Weight (lbs.): 17                      Cubic Feet Per Carton: 14.5</p>	Upholstered seat/polypropylene back.	6961	670	695	714	744	785	805	843	904	950	1002	1108	1221		
					<b>OVERALL DIMENSIONS</b> W D H			<b>SEAT DIMENSIONS</b> W D H			<b>BACK DIMENSIONS</b> W H					
		25	25	31	20.5	18	16	20	15.5							
					<b>RTA 1</b>			1 per carton								



MODA



model 6962



model 6963

Also see Moda Stacking Chairs



For Moda four-legged chairs, please see page 186.

STANDARD FEATURES

- Moda is an upscale, classic looking multi-purpose product, ideal for conference rooms, training, break out and collaboration areas as well as light-use tasking.
- Chairs are molded with a one-piece shell. Available in Night (BLK), Cloud (IVC) or Shadow (SHW).
- Chair frame consists of 0.5" diameter solid steel rod available exclusively in a durable Chrome finish. No crossbar to interfere with feet or leg positions.
- Chairs can be ganged together using ganging clamp set 6970.
- Standard with shell-matching nylon glides (N1), suitable for carpet, rubber or concrete flooring.
- Upholstery options: fabric, vinyl or leather. Not available in leather/mock leather combination.

OPTIONAL FEATURES



- All models are available with optional armcaps in Black self-skinned urethane (SSU), or in Black, White or Clear Grey finish hard plastic.
- Model 6963 armcaps can also be upholstered in the matching fabric, vinyl or leather.
- Glides with felt pads (FG) are available for vinyl sheet, cork or laminate flooring, please specify. Add \$26.
- Glides with felt pads (RG) are available for vinyl sheet, hardwood, laminate, stone or ceramic flooring, please specify. Add \$26.



Please add option codes in the following order:

- **Model number**  
6962 Armchair  
6963 Armchair w/upholstered seat
- **Textile**  
Specify textile code for seat (model 6963 only).
- **Shell color** (no upcharge)  
(BLK) Night  
(IVC) Cloud  
(SHW) Shadow
- **Armcaps**  
(NC) No armcaps.  
(SS) Black SSU. Add \$47.  
(GC) Clear Grey hard plastic. Add \$26.  
(H3) Black hard plastic. Add \$26.  
(H4) White hard plastic. Add \$26.  
(UP) Matching upholstery (upholstered model 6963 only). Add \$52.
- **Glides**  
(N1) Standard nylon. No upcharge.  
(FG) Felt. Add \$26.  
(RG) Rubber. Add \$26.

EXAMPLE MODA ORDER CODE:

6963	-HD05	-IVC	-NC	-N1
Model #	Textile	Shell	Armcaps	Glides

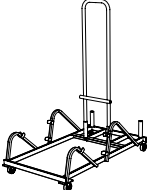
DESCRIPTION	FEATURES	MODEL #	STANDARD TEXTILE GRADES													
			1	2	3	4	5	6	7	8	9	10	11	12		
 <b>Armchair</b> COM Yardage: N/A Freight Class: 300 Product Weight (lbs.): 16 Cubic Feet Per Carton: 15.75	Polypropylene seat & back. Stacks 5 high on floor Stacks 14 high on dolly	6962	505													
					<b>OVERALL DIMENSIONS</b> W D H			<b>SEAT DIMENSIONS</b> W D H			<b>BACK DIMENSIONS</b> W H					
		25	25	31	20.5	18	17	20	15							
					RTA 1			2 per carton								
 <b>Armchair</b> COM Yardage: 0.75 Freight Class: 300 Product Weight (lbs.): 17 Cubic Feet Per Carton: 15.75	Upholstered seat/polypropylene back. Stacks 4 high on floor Stacks 8 high on dolly.	6963	608	633	652	682	724	743	780	841	887	939	1044	1157		
					<b>OVERALL DIMENSIONS</b> W D H			<b>SEAT DIMENSIONS</b> W D H			<b>BACK DIMENSIONS</b> W H					
		25	25	31	20.5	18	17.5	20	15							
					RTA 1			2 per carton								

DESCRIPTION	FEATURES	MODEL #	STANDARD TEXTILE GRADES												
			1	2	3	4	5	6	7	8	9	10	11	12	
 <p><b>Medium Density Dolly</b> COM Yardage: N/A Freight Class: 150 Product Weight (lbs.): 43 Cubic Feet Per Carton: 13.25</p>	For use w/ sled base chairs only	6969	758												
			OVERALL DIMENSIONS			SEAT DIMENSIONS			BACK DIMENSIONS						
		W	D	H	W	D	H	W	H						
		25	63	36.75	-	-	-	-	-						
		RTA 00			1 per carton										
 <p><b>Ganging Clamp</b> COM Yardage: N/A Freight Class: 70 Product Weight (lbs.): 0.13 Cubic Feet Per Carton: 0.3</p>	Two per chair recommended. Packed 2 per bag For use w/ sled base chairs only	6970	42												
			OVERALL DIMENSIONS			SEAT DIMENSIONS			BACK DIMENSIONS						
		W	D	H	W	D	H	W	H						
		3.0	1.5	0.75	-	-	-	-	-						
		RTA 00			UPS			25 per carton							

POPCORN



model 6711



model 6712



Hand Hold Feature.



	Chair Stacking Capability		Stool Stacking Capability
	Stacks on floor	Stacks on dolly	Stacks on floor
<b>Armless</b>			
Polypropylene seat	up to 10 high	up to 34 high	up to 8 high
Upholstered seat	up to 8 high	up to 15 high	up to 8 high
<b>With Arms</b>			
Polypropylene seat	up to 10 high	up to 34 high	up to 8 high
Upholstered seat	up to 8 high	up to 15 high	up to 8 high

STANDARD FEATURES





- Popcorn a high quality stacking chair that is ideal for multi-purpose stack applications within corporate, government and healthcare facilities.
- Chair frame is constructed of 1/2" diameter solid chrome steel rod available exclusively in a durable chrome finish. There is no crossbar to interfere with feet or leg positions. Chrome frame without glides is standard and suitable for cork, rubberized and carpeted floors.
- Wall saver frame design; the base touches the wall before the upper back to protect the wall from damage.
- Upper back features a cut out hand hold to assist in stacking and transportation.
- Seat and back is a one piece polypropylene shell for strength and ease of cleaning and disinfecting.
- Chairs can be ganged together using ganging clamp set (6626), providing a 2" space between armchair models and 5" space between armless models.
- Upholstered models are equipped with a smooth black shroud underneath the seat to help prevent frame imprints on the lower chair while stacked.
- Popcorn beam seating consists of upper seat units (6717, 6719) including mounting brackets and all hardware necessary for attachment to beam.
- For all beam components, tables and a complete list of available upper seat units, see Beam Seating series.
- **Specifications and pricing are for 1 chair.**





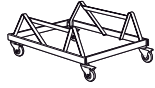
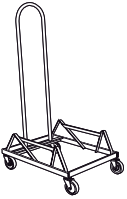

OPTIONAL FEATURES





- Polypropylene shell and coordinating arms are available in 14 designer colors. Choose from Buzz Blue (BZB), Cactus (CCT), Carrot (CRO), Cloud (IVC), Dijon (DJN), Eggplant (EGP), Fog (FOG), Frost (FRO), Ink (INK), Latte (LAB), Night (BLK), Sand (SND), Scarlet (SAR), and Shadow (SHW).
- An optional 18 1/2"D x 18 1/2"W high pressure laminate writing tablet is available. The core is hardwood veneer plywood and the edge is bull nosed and finished in clear lacquer. This writing tablet is offered in the following finishes: Black (D1), Grey (D2), White (D4) and Tiger Maple (D5). Please specify. Add \$45 to list price on desired tablet model.
- Upholstery options: fabric, vinyl or leather. Not available in leather/mock leather combination. Chairs will have additional stitch details when upholstered in vinyl.
- For hard surface flooring casters on Task chairs, please specify (C9R). Add \$51.
- A selection of glide options is available. Glides must be chosen to best suit flooring type and site conditions.
- Clear polycarbonate glides (CG) are available for carpet, rubber or concrete flooring, please specify. Add \$12.
- Glides with felt pads (FG) are available for vinyl sheet, cork or laminate flooring, please specify. Add \$23.
- Glides with rubber pads (RG) are available for vinyl, hardwood, laminate, stone or ceramic flooring, please specify. Add \$23.
- Glides with stainless steel pads (SG) are available for carpet or rubber flooring, please specify. Add \$23.

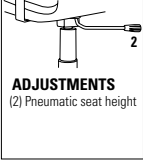

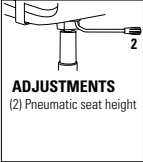

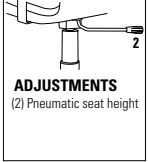
DESCRIPTION	FEATURES	MODEL#	STANDARD TEXTILE GRADES													
			1	2	3	4	5	6	7	8	9	10	11	12		
 <p><b>Armchair</b> COM Yardage: N/A Freight Class: 150 Product Weight (lbs.): 23.50 Cubic Feet Per Carton: 17.75 (4 per carton)</p>	Polypropylene Seat and Back. Stacks 10 high on floor. Stacks 34 high on dolly	<b>6710</b>	242													
			<b>OVERALL DIMENSIONS</b>			<b>SEAT DIMENSIONS</b>			<b>BACK DIMENSIONS</b>							
			<b>W</b>	<b>D</b>	<b>H</b>	<b>W</b>	<b>D</b>	<b>H</b>	<b>W</b>	<b>H</b>						
			24.5	23.5	32.5	18	18	16.5	19.5	16						
			RTA 00													
 <p><b>Armless Chair</b> COM Yardage: N/A Freight Class: 150 Product Weight (lbs.): 15 Cubic Feet Per Carton: 14.75 (4 per carton)</p>	Polypropylene Seat and Back. Stacks 10 high on floor. Stacks 34 high on dolly	<b>6711</b>	160													
			<b>OVERALL DIMENSIONS</b>			<b>SEAT DIMENSIONS</b>			<b>BACK DIMENSIONS</b>							
			<b>W</b>	<b>D</b>	<b>H</b>	<b>W</b>	<b>D</b>	<b>H</b>	<b>W</b>	<b>H</b>						
			20	23.5	32.5	18	18	16.5	19.5	16						
			RTA 00													



DESCRIPTION	FEATURES	MODEL#	STANDARD TEXTILE GRADES											
			1	2	3	4	5	6	7	8	9	10	11	12
 <p><b>Armchair</b> COM Yardage: 0.75 Freight Class: 150 Product Weight (lbs.): 24.50 Cubic Feet Per Carton: 19.25 (4 per carton)</p>	Upholstered seat and Polypropylene Back Stacks 8 high on floor. Stacks 15 high on dolly	<b>6712</b>	318	338	354	376	409	422	450	504	530	580	648	735
			<b>OVERALL DIMENSIONS</b>			<b>SEAT DIMENSIONS</b>			<b>BACK DIMENSIONS</b>					
			<b>W</b>	<b>D</b>	<b>H</b>	<b>W</b>	<b>D</b>	<b>H</b>	<b>W</b>	<b>H</b>				
			24.5	23.5	32.5	18	18	17	19.5	15.5				
			<b>RTA 00</b>											
 <p><b>Armless Chair</b> COM Yardage: 0.75 Freight Class: 150 Product Weight (lbs.): 16 Cubic Feet Per Carton: 16 (4 per carton)</p>	Upholstered seat and Polypropylene Back Stacks 8 high on floor. Stacks 15 high on dolly	<b>6713</b>	235	255	270	294	326	338	367	421	446	498	566	651
			<b>OVERALL DIMENSIONS</b>			<b>SEAT DIMENSIONS</b>			<b>BACK DIMENSIONS</b>					
			<b>W</b>	<b>D</b>	<b>H</b>	<b>W</b>	<b>D</b>	<b>H</b>	<b>W</b>	<b>H</b>				
			20	23.5	32.5	18	18	17	19.5	15.5				
			<b>RTA 00</b>											
 <p><b>Medium Density Dolly</b> COM Yardage: N/A Freight Class: 150 Product Weight (lbs.): 29 Cubic Feet Per Carton: 9</p>	For upholstered models Can stack chairs up to 15 high Fits through standard 80" door frame	<b>6714</b>	541	-	-	-	-	-	-	-	-	-	-	
			<b>OVERALL DIMENSIONS</b>			<b>SEAT DIMENSIONS</b>			<b>BACK DIMENSIONS</b>					
			<b>W</b>	<b>D</b>	<b>H</b>	<b>W</b>	<b>D</b>	<b>H</b>	<b>W</b>	<b>H</b>				
			21.375	31.75	18	-	-	-	-	-				
			<b>RTA 00</b>											
 <p><b>High Density Dolly</b> COM Yardage: N/A Freight Class: 150 Product Weight (lbs.): 30 Cubic Feet Per Carton: 5.5</p>	For polypropylene models Can stack chairs up to 34 high Fits through standard 80" door frame	<b>6715</b>	541	-	-	-	-	-	-	-	-	-	-	
			<b>OVERALL DIMENSIONS</b>			<b>SEAT DIMENSIONS</b>			<b>BACK DIMENSIONS</b>					
			<b>W</b>	<b>D</b>	<b>H</b>	<b>W</b>	<b>D</b>	<b>H</b>	<b>W</b>	<b>H</b>				
			21.375	31.75	51.75	-	-	-	-	-				
			<b>RTA 00</b> 											
 <p><b>Armless Seat Unit</b> COM Yardage: N/A Freight Class: 150 Product Weight (lbs.): 17 Cubic Feet Per Carton: 6.5 (2 per carton)</p>	Polypropylene Seat and Back. Use with beam.	<b>6717</b>	247	-	-	-	-	-	-	-	-	-	-	
			<b>OVERALL DIMENSIONS</b>			<b>SEAT DIMENSIONS</b>			<b>BACK DIMENSIONS</b>					
			<b>W</b>	<b>D</b>	<b>H</b>	<b>W</b>	<b>D</b>	<b>H</b>	<b>W</b>	<b>H</b>				
			20	21	18	18	18	-	19.5	16				
			<b>RTA 00</b>											

DESCRIPTION	FEATURES	MODEL#	STANDARD TEXTILE GRADES											
			1	2	3	4	5	6	7	8	9	10	11	12
 <p><b>Armless Seat Unit</b> COM Yardage: 0.75 Freight Class: 150 Product Weight (lbs.): 18 Cubic Feet Per Carton: 6.5 (2 per carton)</p>	<p><b>Popcorn</b> Upholstered Seat and Polypropylene Back. Use with beam.</p>	<p><b>6719</b></p>	322	343	360	386	421	436	469	521	560	604	695	791
			<b>OVERALL DIMENSIONS</b>			<b>SEAT DIMENSIONS</b>			<b>BACK DIMENSIONS</b>					
			<b>W</b>	<b>D</b>	<b>H</b>	<b>W</b>	<b>D</b>	<b>H</b>	<b>W</b>	<b>H</b>				
			20	21	18	18	18	-	19.5	16				
			<p><b>RTA 00</b></p>											
 <p><b>Ganging Clamp Set - 2 Clamps</b> COM Yardage: N/A Freight Class: 70 Product Weight (lbs.): .30 Cubic Feet Per Carton: .04 (1 set per carton)</p>		<p><b>6626</b></p>	20	-	-	-	-	-	-	-	-	-	-	-
			<b>OVERALL DIMENSIONS</b>			<b>SEAT DIMENSIONS</b>			<b>BACK DIMENSIONS</b>					
			<b>W</b>	<b>D</b>	<b>H</b>	<b>W</b>	<b>D</b>	<b>H</b>	<b>W</b>	<b>H</b>				
			1.00	6.5	0.75	-	-	-	-	-				
			<p><b>RTA 00</b> </p>											
 <p><b>Armless Task</b> COM Yardage: N/A Freight Class: 250 Product Weight (lbs.): 31 Cubic Feet Per Carton: 15.50</p>	 <p><b>ADJUSTMENTS</b> (2) Pneumatic seat height</p>	<p><b>6741</b></p>	<p>List price</p>											
			<p>352</p>											
			<b>OVERALL DIMENSIONS</b>			<b>SEAT DIMENSIONS</b>			<b>BACK DIMENSIONS</b>					
			<b>W</b>	<b>D</b>	<b>H</b>	<b>W</b>	<b>D</b>	<b>H</b>	<b>W</b>	<b>H</b>				
20	23	30.5	18	18	15.5	19.5	16							
			<p><b>RTA 00</b> 1 per carton</p>											
 <p><b>Armless Task w/ Tablet</b> COM Yardage: N/A Freight Class: 250 Product Weight (lbs.): 40 Cubic Feet Per Carton: 15.50</p>	 <p><b>ADJUSTMENTS</b> (2) Pneumatic seat height</p>	<p><b>6741TR</b> <b>6741TL</b></p>	<p>List price</p>											
			<p>590</p>											
			<b>OVERALL DIMENSIONS</b>			<b>SEAT DIMENSIONS</b>			<b>BACK DIMENSIONS</b>					
			<b>W</b>	<b>D</b>	<b>H</b>	<b>W</b>	<b>D</b>	<b>H</b>	<b>W</b>	<b>H</b>				
24.75	26	30.5	18	18	15.5	19.5	16							
			<p><b>RTA 00</b> 1 per carton</p>											
 <p><b>Armless Task</b> COM Yardage: .75 Freight Class: 250 Product Weight (lbs.): 33 Cubic Feet Per Carton: 15.50</p>	 <p><b>ADJUSTMENTS</b> (2) Pneumatic seat height</p>	<p><b>6743</b></p>	432	454	470	496	531	546	579	631	670	714	805	901
			<b>OVERALL DIMENSIONS</b>			<b>SEAT DIMENSIONS</b>			<b>BACK DIMENSIONS</b>					
			<b>W</b>	<b>D</b>	<b>H</b>	<b>W</b>	<b>D</b>	<b>H</b>	<b>W</b>	<b>H</b>				
			20	23	30.5	18	18	16	19.5	16				
			<p><b>RTA 00</b> 1 per carton</p>											

DESCRIPTION	FEATURES	MODEL#	STANDARD TEXTILE GRADES													
			1	2	3	4	5	6	7	8	9	10	11	12		
 <p><b>Armless Task w/Tablet</b> COM Yardage: .75 Freight Class: 250 Product Weight (lbs.): 42 Cubic Feet Per Carton: 15.50</p>	 <p><b>ADJUSTMENTS</b> (2) Pneumatic seat height</p>	<p><b>6743TR</b> <b>6743TL</b></p>	670	690	705	728	761	776	806	853	889	931	1013	1103		
			<b>OVERALL DIMENSIONS</b>			<b>SEAT DIMENSIONS</b>			<b>BACK DIMENSIONS</b>							
			<b>W</b>	<b>D</b>	<b>H</b>	<b>W</b>	<b>D</b>	<b>H</b>	<b>W</b>	<b>H</b>						
			24.75	26	30.5	18	18	16	19.5	16						
<p>Upholstered seat/polypropylene back.</p> <p>Ergonomic features: C</p> <p><b>Specify (L) left or (R) right tablet.</b></p>			<b>RTA 00</b>	1 per carton												
 <p><b>Barstool w/Arms</b> COM Yardage: N/A Freight Class: 250 Product Weight (lbs.):29 Cubic Feet Per Carton: 21.50 (2 per carton)</p>	<p>Polypropylene Seat and Back. Stacks 8 high on floor.</p>	<p><b>6710BS</b></p>	393													
			<b>OVERALL DIMENSIONS</b>			<b>SEAT DIMENSIONS</b>			<b>BACK DIMENSIONS</b>							
			<b>W</b>	<b>D</b>	<b>H</b>	<b>W</b>	<b>D</b>	<b>H</b>	<b>W</b>	<b>H</b>						
			24.5	25.5	44.5	18	18	29	19.5	16						
			<b>RTA 00</b>													
 <p><b>Counter stool w/Arms</b> COM Yardage: N/A Freight Class: 250 Product Weight (lbs.): 24 Cubic Feet Per Carton: 21.50 (2 per carton)</p>	<p>Polypropylene Seat and Back. Stacks 8 high on floor.</p>	<p><b>6710CS</b></p>	393													
			<b>OVERALL DIMENSIONS</b>			<b>SEAT DIMENSIONS</b>			<b>BACK DIMENSIONS</b>							
			<b>W</b>	<b>D</b>	<b>H</b>	<b>W</b>	<b>D</b>	<b>H</b>	<b>W</b>	<b>H</b>						
			24.5	25.5	40.5	18	18	24	19.5	16						
			<b>RTA 00</b>													
 <p><b>Armless Barstool</b> COM Yardage: N/A Freight Class: 250 Product Weight (lbs.): 27 Cubic Feet Per Carton:17.50 (2 per carton)</p>	<p>Polypropylene Seat and Back. Stacks 8 high on floor.</p>	<p><b>6711BS</b></p>	283													
			<b>OVERALL DIMENSIONS</b>			<b>SEAT DIMENSIONS</b>			<b>BACK DIMENSIONS</b>							
			<b>W</b>	<b>D</b>	<b>H</b>	<b>W</b>	<b>D</b>	<b>H</b>	<b>W</b>	<b>H</b>						
			20	25.5	44.5	18	18	29	19.5	16						
			<b>RTA 00</b>													
 <p><b>Armless Counter Stool</b> COM Yardage: N/A Freight Class: 250 Product Weight (lbs.): 22 Cubic Feet Per Carton: 17.50 (2 per carton)</p>	<p>Polypropylene Seat and Back. Stacks 8 high on floor.</p>	<p><b>6711CS</b></p>	283													
			<b>OVERALL DIMENSIONS</b>			<b>SEAT DIMENSIONS</b>			<b>BACK DIMENSIONS</b>							
			<b>W</b>	<b>D</b>	<b>H</b>	<b>W</b>	<b>D</b>	<b>H</b>	<b>W</b>	<b>H</b>						
			20	25.5	40.5	18	18	24	19.5	16						
			<b>RTA 00</b>													

DESCRIPTION	FEATURES	MODEL#	STANDARD TEXTILE GRADES											
			1	2	3	4	5	6	7	8	9	10	11	12
 <p><b>Barstool w/Arms</b> COM Yardage: 0.75 Freight Class: 150 Product Weight (lbs.): 27 Cubic Feet Per Carton: 21.5 (2 per carton)</p>	Upholstered seat and Polypropylene Back Stacks 8 high on floor.	<b>6712BS</b>	473	496	512	537	572	589	622	672	712	755	846	942
			<b>OVERALL DIMENSIONS</b>			<b>SEAT DIMENSIONS</b>			<b>BACK DIMENSIONS</b>					
			<b>W</b>	<b>D</b>	<b>H</b>	<b>W</b>	<b>D</b>	<b>H</b>	<b>W</b>	<b>H</b>				
			24.5	25.5	44.5	18	18	29.5	19.5	16				
			<b>RTA 00</b>											
 <p><b>Counter Stool w/Arms</b> COM Yardage: 0.75 Freight Class: 150 Product Weight (lbs.): 22 Cubic Feet Per Carton: 21.5 (2 per carton)</p>	Upholstered seat and Polypropylene Back Stacks 8 high on floor.	<b>6712CS</b>	473	496	512	537	572	589	622	672	712	755	846	942
			<b>OVERALL DIMENSIONS</b>			<b>SEAT DIMENSIONS</b>			<b>BACK DIMENSIONS</b>					
			<b>W</b>	<b>D</b>	<b>H</b>	<b>W</b>	<b>D</b>	<b>H</b>	<b>W</b>	<b>H</b>				
			24.5	25.5	40.5	18	18	24.5	19.5	16				
			<b>RTA 00</b>											
 <p><b>Armless Barstool</b> COM Yardage: 0.75 Freight Class: 150 Product Weight (lbs.): 28 Cubic Feet Per Carton: 17.5 (2 per carton)</p>	Upholstered seat and Polypropylene Back Stacks 8 high on floor.	<b>6713BS</b>	386	407	424	449	484	500	533	585	624	667	758	853
			<b>OVERALL DIMENSIONS</b>			<b>SEAT DIMENSIONS</b>			<b>BACK DIMENSIONS</b>					
			<b>W</b>	<b>D</b>	<b>H</b>	<b>W</b>	<b>D</b>	<b>H</b>	<b>W</b>	<b>H</b>				
			20	25.5	44.5	18	18	29.5	19.5	16				
			<b>RTA 00</b>											
 <p><b>Armless Counter Stool</b> COM Yardage: 0.75 Freight Class: 150 Product Weight (lbs.): 20 Cubic Feet Per Carton: 17.5 (2 per carton)</p>	Upholstered seat and Polypropylene Back Stacks 8 high on floor.	<b>6713CS</b>	386	407	424	449	484	500	533	585	624	667	758	853
			<b>OVERALL DIMENSIONS</b>			<b>SEAT DIMENSIONS</b>			<b>BACK DIMENSIONS</b>					
			<b>W</b>	<b>D</b>	<b>H</b>	<b>W</b>	<b>D</b>	<b>H</b>	<b>W</b>	<b>H</b>				
			20	25.5	40.5	18	18	24.5	19.5	16				
			<b>RTA 00</b>											

ROMA® NESTER



model 1898



model 1899

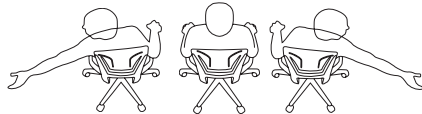

(Models 1890, 190L, 1900, 1900L)

The Polypropylene Medium Back and the Upholstered Medium Back feature a flexible back construction that provides support, proper spinal alignment and comfort when moving or reaching in a seated position.

STANDARD FEATURES

- Flexible, elegant and affordable, Roma offers a family of seating with simple clean lines.
- Please see Work + Task section for additional Roma models.
- Four back versions are available. Choose from Mesh, Flexible Polypropylene or Honeycomb Polypropylene back.
- All "L" models have two piece seats with a radius towards the rear of the seat.
- Flexible polypropylene back chair features a built in lumbar support designed to move as you move and is available exclusively in black.
- The horizontal nesting chairs are easy to store. Simply flip the seat upward and then roll into nesting position, like a shopping cart.
- When nesting horizontal nesting chairs, each additional chair adds 8" to depth.
- Arms are durable fiberglass reinforced Nylon, fixed height. Armcaps are durable Polyurethane (SSU), soft and warm to the touch.
- Nesting chairs are available in Tungsten (TUN) or Black (BLK).
- C1 casters are standard.

OPTIONAL FEATURES

- Breathable mesh back is available in six colors. Choose from Autumn Orange (AO), Spring Green (SG) Winter Grey (WG), Midnight Black (MB), Summer Blue (SB), Fall Burgundy (FB).
- Nesting chair are available in a Chrome frame is an option. Please specify (CHM), Add \$30.
- Available in fabric and leather with the EXCEPTION of Imprint and Renewal.

DESCRIPTION

FEATURES

MODEL#

STANDARD TEXTILE GRADES



Honeycomb MB - Armless Flip Seat Nesting Chair

COM Yardage: 1  
 Freight Class: 250  
 Product Weight (lbs.): 29  
 Cubic Feet Per Carton: 13.75

Nesting chair.  
 Ergonomic Features:  
 M, N

	1	2	3	4	5	6	7	8	9	10	11	12
<b>1888</b>	522	548	569	599	643	658	697	769	804	871	961	1077
<b>1888L</b> Leather	-	-	-	-	-	-	-	780	828	886	987	1101
<b>OVERALL DIMENSIONS</b>			<b>SEAT DIMENSIONS</b>			<b>BACK DIMENSIONS</b>						
<b>W</b>	<b>D</b>	<b>H</b>	<b>W</b>	<b>D</b>	<b>H</b>	<b>W</b>	<b>H</b>					
24.5	23.5	36	19.5	17	18	18.5	18					

RTA 00



Mesh MB - Armless Flip Seat Nesting Chair

COM Yardage: 1  
 Freight Class: 250  
 Product Weight (lbs.): 29  
 Cubic Feet Per Carton: 13.75

Nesting chair.  
 Ergonomic Features:  
 M, N

	1	2	3	4	5	6	7	8	9	10	11	12
<b>1889</b>	522	548	569	599	643	658	697	769	804	871	961	1077
<b>1889L</b> Leather	-	-	-	-	-	-	-	794	841	900	1000	1113
<b>OVERALL DIMENSIONS</b>			<b>SEAT DIMENSIONS</b>			<b>BACK DIMENSIONS</b>						
<b>W</b>	<b>D</b>	<b>H</b>	<b>W</b>	<b>D</b>	<b>H</b>	<b>W</b>	<b>H</b>					
24.5	23.5	36	19.5	17	18	18.5	18					

RTA 00



Polypropylene MB - Armless Flip Seat Nesting Chair

COM Yardage: 1  
 Freight Class: 250  
 Product Weight (lbs.): 29





Nesting chair.  
 Ergonomic Features:

Cubic Feet Per Carton: 13.75

M, N

	1	2	3	4	5	6	7	8	9	10	11	12
<b>1890</b>	522	548	569	599	643	658	697	769	804	871	961	1077
<b>1890L</b> Leather	-	-	-	-	-	-	-	794	841	900	1000	1113
<b>OVERALL DIMENSIONS</b>			<b>SEAT DIMENSIONS</b>			<b>BACK DIMENSIONS</b>						
<b>W</b>	<b>D</b>	<b>H</b>	<b>W</b>	<b>D</b>	<b>H</b>	<b>W</b>	<b>H</b>					
24.5	23.5	36	19.5	17	18	18.5	18					

RTA 00

DESCRIPTION	FEATURES	MODEL#	STANDARD TEXTILE GRADES											
			1	2	3	4	5	6	7	8	9	10	11	12
 <p><b>Honeycomb MB - Flip Seat Nesting Armchair</b> COM Yardage: 1 Freight Class: 250 Product Weight (lbs.): 30 Cubic Feet Per Carton: 13.75</p>	Nesting chair.  Ergonomic Features: M, N	1898	567	594	614	645	689	703	742	814	849	917	1008	1122
		1898L	-	-	-	-	-	-	-	768	814	873	974	1086
		<b>OVERALL DIMENSIONS</b>			<b>SEAT DIMENSIONS</b>			<b>BACK DIMENSIONS</b>						
		W D H			W D H			W H						
		24.5 23.5 36			19.5 17 18			18.5 18						
			<b>RTA 00</b>											
 <p><b>Mesh MB - Flip Seat Nesting Armchair</b> COM Yardage: 1 Freight Class: 250 Product Weight (lbs.): 30 Cubic Feet Per Carton: 13.75</p>	Nesting chair.  Ergonomic Features: M, N	1899	567	593	613	644	688	702	741	812	848	916	1007	1121
		1899L	-	-	-	-	-	-	-	775	822	881	981	1095
		<b>OVERALL DIMENSIONS</b>			<b>SEAT DIMENSIONS</b>			<b>BACK DIMENSIONS</b>						
		W D H			W D H			W H						
		24.5 23.5 36			19.5 17 18			18.5 18						
			<b>RTA 00</b>											
 <p><b>Polypropylene MB - Flip Seat Nesting Armchair</b> COM Yardage: 1 Freight Class: 250 Product Weight (lbs.): 30 Cubic Feet Per Carton: 13.75</p>	Nesting chair.  Ergonomic Features: M, N	1900	567	593	613	644	688	702	741	812	848	916	1007	1121
		1900L	-	-	-	-	-	-	-	775	822	881	981	1095
		<b>OVERALL DIMENSIONS</b>			<b>SEAT DIMENSIONS</b>			<b>BACK DIMENSIONS</b>						
		W D H			W D H			W H						
		24.5 23.5 36			19.5 17 18			18.5 18						
			<b>RTA 00</b>											
 <p><b>Upholstered Back Pad</b> COM Yardage: 1 Freight Class: 70 Product Weight (lbs.): 1.50 Cubic Feet Per Carton: 1.10</p>		1909	140	167	189	222	267	283	323	398	436	506	603	723
		1909L	-	-	-	-	-	-	-	393	442	503	609	728
		<b>OVERALL DIMENSIONS</b>			<b>SEAT DIMENSIONS</b>			<b>BACK DIMENSIONS</b>						
		W D H			W D H			W H						
		20.5 19 .38			21 18 18			20 20.5						
			<b>RTA 00</b>											

SAS™



Mid Back Side Chair  
model 8647



Low Back Counter Stool  
model 8648LBNS24



Mid Back Counter Stool  
model 8648PS24



Mid Back Bar Stool  
model 8648PS30

STANDARD FEATURES

- The Sas side chair and stools have a single, molded plywood shell of wood veneer.
- Available with two seat options: unupholstered seat and upholstered seat (P).
- Available in three heights: side chair, counter stool and bar stool.
- Sas side chair in mid back height only. Counter and bar height stools available with mid or low backs.
- Dimensions shown are for unupholstered models.
- Unupholstered side chairs can be stacked up to 4 high on the floor and up to 10 high on the available dolly. Unupholstered stools can be stacked up to 4 high on the floor only. Upholstered models cannot be stacked.

OPTIONAL FEATURES

Tubular frame is available in the following finishes:

- **Frame**
  - (BK) Black frame finish.....**Standard**
  - (DWT) Designer White frame finish.....**Standard**
  - (TU) Tungsten frame finish.....**Standard**
  - (CH) Chrome frame finish.....**Add \$85**

One piece shell wood seat and back are available in the following finishes:

- **Shell**
    - (AAM) Absolute
    - (BKM) Black
    - (ACM) Cherry
    - (EOM) English Oak
    - (ECM) Espresso Cafe
    - (TFM) Fruitwood
    - (HGM) Gray
    - (AHM) Honey
    - (TMM) Mahogany
    - (AVM) Maple
    - (MWM) Medium Walnut
    - (ASM) Night
    - (SKM) Shaker Cherry
    - (TWM) Walnut
    - (WTM) WC Cream
    - (WHM) White
    - (WCM) Winter Cherry
- Please Specify.

EXAMPLE SAS ORDER CODE:

8647P	-BK	-AAM	-HD05
-------	-----	------	-------

Model #      Frame Color      Shell      Textile

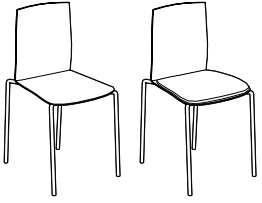
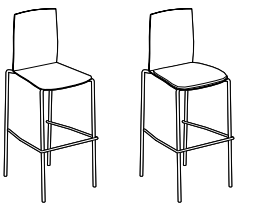
DESCRIPTION	FEATURES	MODEL#	STANDARD TEXTILE GRADES											
			1	2	3	4	5	6	7	8	9	10	11	12
 <p><b>Mid Back Side Chair</b> COM Yardage: 0.75 Freight Class: 250 Product Weight (lbs.): 12 Cubic Feet Per Carton: 12</p>	<p>Stacks 4 high on floor. Stacks 10 high on dolly. Upholstered models do not stack.</p>	<b>8647</b>	430	-	-	-	-	-	-	-	-	-	-	-
		<b>8647P</b> Upholstered Seat	525	544	559	581	613	628	657	702	738	777	857	944
		<b>OVERALL DIMENSIONS</b>	<b>W</b>	<b>D</b>	<b>H</b>	<b>SEAT DIMENSIONS</b>	<b>W</b>	<b>D</b>	<b>H</b>	<b>BACK DIMENSIONS</b>	<b>W</b>	<b>H</b>		
		18.75	21	33	16	15.5	18	16	15					
		<b>RTA 00</b>	2 per carton											
 <p><b>Mid Back Counter Stool, 24"</b> COM Yardage: 0.75 Freight Class: 400 Product Weight (lbs.): 16 Cubic Feet Per Carton: 14.5</p>	<p>Stacks 4 high on floor only. Upholstered models do not stack.</p>	<b>8648S24</b>	600	-	-	-	-	-	-	-	-	-	-	
		<b>8648PS24</b> Upholstered Seat	695	713	727	748	779	793	820	863	897	934	1011	1093
		<b>OVERALL DIMENSIONS</b>	<b>W</b>	<b>D</b>	<b>H</b>	<b>SEAT DIMENSIONS</b>	<b>W</b>	<b>D</b>	<b>H</b>	<b>BACK DIMENSIONS</b>	<b>W</b>	<b>H</b>		
		19.5	22	39	16	15.5	24	16	15					
		<b>RTA 00</b>	1 per carton											

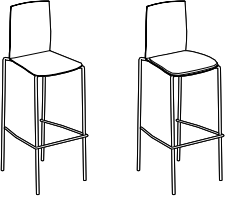
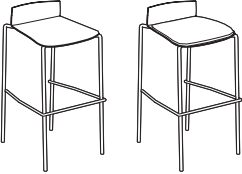
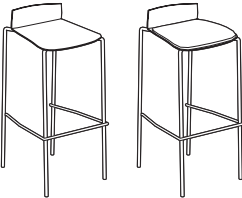
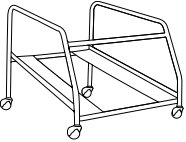
DESCRIPTION	FEATURES	MODEL#	STANDARD TEXTILE GRADES											
			1	2	3	4	5	6	7	8	9	10	11	12
 <p><b>Mid Back Bar Stool, 30"</b> COM Yardage: 0.75 Freight Class: 400 Product Weight (lbs.): 16 Cubic Feet Per Carton: 14.5</p>	Stacks 4 high on floor only. Upholstered models do not stack.	<b>8648S30</b>	600	-	-	-	-	-	-	-	-	-	-	
		<b>8648PS30</b>	695	713	727	748	779	793	820	863	897	934	1011	1093
		<b>OVERALL DIMENSIONS</b>			<b>SEAT DIMENSIONS</b>			<b>BACK DIMENSIONS</b>						
		<b>W</b>	<b>D</b>	<b>H</b>	<b>W</b>	<b>D</b>	<b>H</b>	<b>W</b>	<b>H</b>					
			19.5	22	39	16	15.5	30	16	15				
			<b>RTA 00</b>		1 per carton									
 <p><b>Low Back Counter Stool, 24"</b> COM Yardage: 0.75 Freight Class: 400 Product Weight (lbs.): 16 Cubic Feet Per Carton: 8.25</p>	Stacks 4 high on floor only. Upholstered models do not stack.	<b>8648LBNS24</b>	600	-	-	-	-	-	-	-	-	-	-	
		<b>8648LBPS24</b>	695	713	727	748	779	793	820	863	897	934	1011	1093
		<b>OVERALL DIMENSIONS</b>			<b>SEAT DIMENSIONS</b>			<b>BACK DIMENSIONS</b>						
		<b>W</b>	<b>D</b>	<b>H</b>	<b>W</b>	<b>D</b>	<b>H</b>	<b>W</b>	<b>H</b>					
			19.5	22	26.25	16	15.5	24	16	2.25				
			<b>RTA 00</b>		1 per carton									
 <p><b>Low Back Bar Stool, 30"</b> COM Yardage: 0.75 Freight Class: 400 Product Weight (lbs.): 22 Cubic Feet Per Carton: 17</p>	Stacks 4 high on floor only. Upholstered models do not stack.	<b>8648LBNS30</b>	600	-	-	-	-	-	-	-	-	-	-	
		<b>8648LBPS30</b>	695	713	727	748	779	793	820	863	897	934	1011	1093
		<b>OVERALL DIMENSIONS</b>			<b>SEAT DIMENSIONS</b>			<b>BACK DIMENSIONS</b>						
		<b>W</b>	<b>D</b>	<b>H</b>	<b>W</b>	<b>D</b>	<b>H</b>	<b>W</b>	<b>H</b>					
			19.5	22	32.5	16	15.5	30	16	2.25				
			<b>RTA 00</b>		1 per carton									
 <p><b>Dolly</b> COM Yardage: N/A Freight Class: 250 Product Weight (lbs.): 19 Cubic Feet Per Carton: 10.75</p>		<b>8649</b>	365	-	-	-	-	-	-	-	-	-	-	
		<b>OVERALL DIMENSIONS</b>			<b>SEAT DIMENSIONS</b>			<b>BACK DIMENSIONS</b>						
		<b>W</b>	<b>D</b>	<b>H</b>	<b>W</b>	<b>D</b>	<b>H</b>	<b>W</b>	<b>H</b>					
					25.75	28.5	22	-	-	-	-	-		
			<b>RTA 00</b>		1 per carton									



SIDERO



model 6901 (BLK)



model 6900 (BLK) Stacked



model 6900C



model 6905

	Sidero Chairs Stacking Capability	
	Stacking on floor	Stacking on dolly
<b>Models Types</b>		
Arm Chairs without Casters	up to 5 high	up to 8 high
Arm Chairs with Casters	up to 3 high	N/A
Armless Chairs without Casters	up to 5 high	up to 8 high
Armless Chairs with Casters	up to 3 high	N/A
Preschool Armless Models	up to 4 high	N/A

STANDARD FEATURES

- Sidero seating has a sculptured appearance, featuring wide curved arms and a round tubular steel frame, with wall safe construction.
- Sidero series includes side chairs (arms and armless), available with casters or with a sled base, counter stools and barstools.
- Arms are 2 1/8 inches wide and full length, offering support to help stabilize users as they sit in or exit chairs.
- The gently curved arms are made from incredibly strong fiberglass reinforced nylon.
- The back of the chair is compound curved to provide comfort and support in multiple seating positions. No visible back attachment hardware. Backs are attached using concealed hardware only.
- The outer back is upholstered in the same material selection as the rest of the chair.
- Chairs are "Wall Safe." Rear legs hit the baseboard first leaving clearance between the back of the chair and the wall, saving both the chair and the wall from damage.
- Legs flair out to the rear to provide additional stability.
- The rugged steel frame is made from round welded steel tubing 7/8" dia.
- Armchairs (four legged and sled base) can be joined together using ganging clamp model 5233. Armless chairs (four legged and sled base) can be joined together using ganging clamp model 6526.
- Equipped with a polypropylene seat shroud that helps stabilize chairs when stacked and avoid frame imprints on upholstered seats.
- Four legged models can be stacked. Stools and sled base models do not stack. Please note when stacking painted frame chairs, paint may scratch.
- Standard glide is a durable Black Polypropylene foot.
- Four Legged chairs with casters are standard with (C82) dual wheel carpet casters.
- Sidero beam seating consists of upper seat units (6930, 6931) including mounting brackets and all hardware necessary for attachment to beam.

- For all beam components, tables and a complete list of available upper seat units, see Beam Seating series.
- Tablet arms are extremely rugged, suitable for armed forces and student use. Tablet hinges up to allow ease of egress. Tablet slides forward and back to accommodate any body size comfortably. Tablet models do not stack.
- Standard tablet (D8) size is 18"D x 14.5"W and is made of Black polymer. Tablets are attached at the left or right (as seated) Tablet arms are not available on stools. Specify (L) left or (R) right tablet. (Example: 6900TL or 6900TR).

OPTIONAL FEATURES

- A choice of Black (BLK) or Tungsten (TUN) finish must be specified. No upcharge.
- A Chrome (CH) frame is optionally available, Please Specify and Add \$30.
- An optional 18.5"D x 18.5"W high pressure laminate writing tablet is available. The core is hardwood veneer plywood and the edge is bull nosed and finished in clear lacquer. This writing tablet is offered in the following finishes: Black (D1), Grey (D2), White (D4) and Tiger Maple (D5). Please specify. Add \$45.
- For chairs used on hard surface floors PLEASE SPECIFY Opaque (off White) Non-Marking Glides (NM). No upcharge.
- Steel self-leveling rubber cushioned glide is optionally available Please specify (B), add \$23.
- For hard surface flooring please Specify (C9R) with rubber covered wheels. Add \$68.
- Available in fabric and leather with the EXCEPTION of Crescent, Jenny, Match, Quilt and Couture.
- Optional ballistic nylon outer back fabric available. Resistant to impact damage, only in Black (BKB). Add \$15.
- Optional 1 inch additional seat foam. Please specify (3F). Add \$29.

DESCRIPTION FEATURES MODEL# STANDARD TEXTILE GRADES



**Armchair**  
COM Yardage: 1.25  
Freight Class: 300  
Product Weight (lbs.): 25  
Cubic Feet Per Carton: 13.50

Stacks 5 high on floor.  
Stacks 8 high on dolly.  
Tablet models do not stack.

Available with tablet:  
Specify (L) left or (R) right tablet.

MODEL#	1	2	3	4	5	6	7	8	9	10	11	12
6900	412	444	470	507	563	581	630	720	764	848	961	1105
6900T	647	679	704	742	796	821	870	946	1007	1073	1210	1355
6900LM	-	-	-	-	544	-	-	703	-	830	-	-
6900LMT	-	-	-	-	772	-	-	919	-	1042	-	-

OVERALL DIMENSIONS			SEAT DIMENSIONS			BACK DIMENSIONS		
W	D	H	W	D	H	W	H	
25.5	24	33	19.5	18	17.5	19	15.5	



**Armchair w/ Casters**  
COM Yardage: 1.25  
Freight Class: 300  
Product Weight (lbs.): 25  
Cubic Feet Per Carton: 13.50





Stacks 3 high on floor.  
Tablet models do not stack.





Available with tablet:  
Specify (L) left or (R) right tablet.



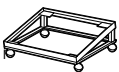

MODEL#	1	2	3	4	5	6	7	8	9	10	11	12
6900C	469	501	527	566	621	640	688	777	821	905	1019	1161
6900CT	690	720	743	779	830	853	900	973	1028	1090	1219	1356
6900CLM	-	-	-	-	597	-	-	755	-	882	-	-
6900CLMT	-	-	-	-	813	-	-	953	-	1070	-	-

OVERALL DIMENSIONS			SEAT DIMENSIONS			BACK DIMENSIONS		
W	D	H	W	D	H	W	H	
25.5	24	33	19.5	18	17.5	19	15.5	

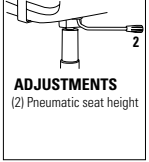

DESCRIPTION	FEATURES	MODEL#	STANDARD TEXTILE GRADES																
			1	2	3	4	5	6	7	8	9	10	11	12					
 <p><b>Side Chair</b> COM Yardage: 1.25 Freight Class: 250 Product Weight (lbs.): 23 Cubic Feet Per Carton: 11.25</p> <p>Stacks 5 high on floor. Stacks 8 high on dolly. Tablet models do not stack.</p> <p>Available with tablet: Specify (L) left or (R) right tablet.</p>																			
	<b>6901</b>	372	404	430	468	523	542	591	680	724	808	922	1064						
	<b>6901T</b>	599	630	655	691	743	768	814	889	948	1012	1144	1285						
	<b>6901LM</b>	-	-	-	-	500	-	-	659	-	785	-	-						
	<b>6901LMT</b>	-	-	-	-	720	-	-	864	-	981	-	-						
	<b>OVERALL DIMENSIONS</b>			<b>SEAT DIMENSIONS</b>			<b>BACK DIMENSIONS</b>												
	<b>W</b>	<b>D</b>	<b>H</b>	<b>W</b>	<b>D</b>	<b>H</b>	<b>W</b>	<b>H</b>											
	21	24	33	19.5	18	17.5	19	15.5											
	 <p><b>Side Chair w/ Casters</b> COM Yardage: 1.25 Freight Class: 250 Product Weight (lbs.): 23 Cubic Feet Per Carton: 11.25</p> <p>Stacks 3 high on floor. Tablet models do not stack.</p> <p>Available with tablet: Specify (L) left or (R) right tablet.</p>																		
<b>6901C</b>		446	479	505	543	598	617	666	755	799	883	998	1140						
<b>6901CT</b>		682	713	738	774	827	850	898	973	1030	1095	1227	1368						
<b>6901CLM</b>		-	-	-	-	574	-	-	733	-	861	-	-						
<b>6901CLMT</b>		-	-	-	-	793	-	-	934	-	1050	-	-						
<b>OVERALL DIMENSIONS</b>			<b>SEAT DIMENSIONS</b>			<b>BACK DIMENSIONS</b>													
<b>W</b>		<b>D</b>	<b>H</b>	<b>W</b>	<b>D</b>	<b>H</b>	<b>W</b>	<b>H</b>											
21		24	33	19.5	18	17.5	19	15.5											
 <p><b>Armchair - Sled Base</b> COM Yardage: 1.25 Freight Class: 300 Product Weight (lbs.): 26 Cubic Feet Per Carton: 13.50</p> <p>Does not stack.</p> <p>Available with tablet: Specify (L) left or (R) right tablet.</p>																			
	<b>6902</b>	515	548	574	612	667	685	734	824	868	952	1066	1209						
	<b>6902T</b>	753	786	811	849	904	929	979	1057	1118	1185	1323	1470						
	<b>6902LM</b>	-	-	-	-	652	-	-	811	-	938	-	-						
	<b>6902LMT</b>	-	-	-	-	886	-	-	1037	-	1162	-	-						
	<b>OVERALL DIMENSIONS</b>			<b>SEAT DIMENSIONS</b>			<b>BACK DIMENSIONS</b>												
	<b>W</b>	<b>D</b>	<b>H</b>	<b>W</b>	<b>D</b>	<b>H</b>	<b>W</b>	<b>H</b>											
	25.5	24	33	19.5	18	17.5	19	15.5											
	 <p><b>Side Chair - Sled Base</b> COM Yardage: 1.25 Freight Class: 250 Product Weight (lbs.): 23 Cubic Feet Per Carton: 11.25</p> <p>Does not stack.</p> <p>Available with tablet: Specify (L) left or (R) right tablet.</p>																		
<b>6903</b>		478	511	537	574	629	648	697	786	830	914	1028	1172						
<b>6903T</b>		708	740	764	801	854	879	926	1004	1061	1126	1261	1404						
<b>6903LM</b>		-	-	-	-	611	-	-	770	-	897	-	-						
<b>6903LMT</b>		-	-	-	-	837	-	-	983	-	1105	-	-						
<b>OVERALL DIMENSIONS</b>			<b>SEAT DIMENSIONS</b>			<b>BACK DIMENSIONS</b>													
<b>W</b>		<b>D</b>	<b>H</b>	<b>W</b>	<b>D</b>	<b>H</b>	<b>W</b>	<b>H</b>											
21		24	33	19.5	18	17.5	19	15.5											
 <p><b>Dolly</b> COM Yardage: N/A Freight Class: 150 Product Weight (lbs.): 16 Cubic Feet Per Carton: 3.80</p>																			
	<b>2125WS</b>	316	-	-	-	-	-	-	-	-	-	-	-						
	<b>OVERALL DIMENSIONS</b>			<b>SEAT DIMENSIONS</b>			<b>BACK DIMENSIONS</b>												
	<b>W</b>	<b>D</b>	<b>H</b>	<b>W</b>	<b>D</b>	<b>H</b>	<b>W</b>	<b>H</b>											
	23.25	24.75	12.25	-	-	-	-	-											

DESCRIPTION	FEATURES	MODEL#	STANDARD TEXTILE GRADES											
			1	2	3	4	5	6	7	8	9	10	11	12
 <p><b>Counter Stool w/Arms</b> COM Yardage: 1.25 Freight Class: 300 Product Weight (lbs.): 28 Cubic Feet Per Carton: 18.75</p>	Does not stack.	<b>6904</b>	558	592	617	655	709	730	777	868	910	995	1109	1252
		<b>6904LM</b>	-	-	-	-	743	-	-	902	-	1028	-	-
		<b>OVERALL DIMENSIONS</b>			<b>SEAT DIMENSIONS</b>			<b>BACK DIMENSIONS</b>						
		<b>W D H</b>			<b>W D H</b>			<b>W H</b>						
		25.5 24 40.5			19.5 18 24.5			19 15.5						
<b>RTA 00</b>														
 <p><b>Armless Counter Stool</b> COM Yardage: 1.25 Freight Class: 300 Product Weight (lbs.): 25 Cubic Feet Per Carton: 14.50</p>	Does not stack.	<b>6905</b>	513	544	571	608	664	682	731	821	865	949	1062	1206
		<b>6905LM</b>	-	-	-	-	645	-	-	804	-	931	-	-
		<b>OVERALL DIMENSIONS</b>			<b>SEAT DIMENSIONS</b>			<b>BACK DIMENSIONS</b>						
		<b>W D H</b>			<b>W D H</b>			<b>W H</b>						
		21 24 40.5			19.5 18 24.5			19 15.5						
<b>RTA 00</b>														
 <p><b>Barstool w/Arms</b> COM Yardage: 1.25 Freight Class: 300 Product Weight (lbs.): 30 Cubic Feet Per Carton: 20</p>	Does not stack.	<b>6906</b>	582	616	643	680	735	754	803	894	936	1021	1135	1278
		<b>6906LM</b>	-	-	-	-	715	-	-	873	-	1000	-	-
		<b>OVERALL DIMENSIONS</b>			<b>SEAT DIMENSIONS</b>			<b>BACK DIMENSIONS</b>						
		<b>W D H</b>			<b>W D H</b>			<b>W H</b>						
		25.5 24 44.5			19.5 18 28.5			19 15.5						
<b>RTA 00</b>														
 <p><b>Armless Barstool</b> COM Yardage: 1.25 Freight Class: 300 Product Weight (lbs.): 27 Cubic Feet Per Carton: 15.75</p>	Does not stack.	<b>6907</b>	526	558	585	623	677	697	744	834	878	961	1077	1219
		<b>6907LM</b>	-	-	-	-	659	-	-	817	-	944	-	-
		<b>OVERALL DIMENSIONS</b>			<b>SEAT DIMENSIONS</b>			<b>BACK DIMENSIONS</b>						
		<b>W D H</b>			<b>W D H</b>			<b>W H</b>						
		21 24 44.5			19.5 18 28.5			19 15.5						
<b>RTA 00</b>														

DESCRIPTION	FEATURES	MODEL#	STANDARD TEXTILE GRADES													
			1	2	3	4	5	6	7	8	9	10	11	12		
 <p><b>Armless Chair - 13" High Seat</b> COM Yardage: 1 Freight Class: 250 Product Weight (lbs.): 15 Cubic Feet Per Carton: 4.10</p>	<p>Stack up to 4 high on floor. For Preschool to Grade 2.</p>	6909	333	360	380	411	454	469	507	579	615	682	774	887		
			<b>OVERALL DIMENSIONS</b>			<b>SEAT DIMENSIONS</b>			<b>BACK DIMENSIONS</b>							
			<b>W</b>	<b>D</b>	<b>H</b>	<b>W</b>	<b>D</b>	<b>H</b>	<b>W</b>	<b>H</b>						
			15.5	15.5	24	14	10	13	13.5	11						
			<b>RTA 00</b>													
 <p><b>Armless Task</b> COM Yardage: 1.25 Freight Class: 250 Product Weight (lbs.): 25 Cubic Feet Per Carton: 15.5</p>	 <p><b>ADJUSTMENTS</b> (2) Pneumatic seat height</p>	<p>Upholstered seat &amp; back. Ergonomic features: C, M, N</p> <p>Available with tablet: Specify (L) left or (R) right tablet.</p>	6915	672	705	731	769	823	849	899	977	1038	1106	1245	1392	
				6915T	910	943	969	1007	1061	1087	1137	1215	1277	1344	1483	1630
				6915LM	-	-	-	-	823	-	-	977	-	1106	-	-
				6915LMT	-	-	-	-	1061	-	-	1215	-	1344	-	-
<b>OVERALL DIMENSIONS</b>			<b>SEAT DIMENSIONS</b>			<b>BACK DIMENSIONS</b>										
<b>W</b>	<b>D</b>	<b>H</b>	<b>W</b>	<b>D</b>	<b>H</b>	<b>W</b>	<b>H</b>									
21	29	35	19.5	18	16-21	19	15.5									
			<b>RTA 00</b>													
			1 per carton													
 <p><b>Seat Unit w/Arms</b> COM Yardage: 1.25 Freight Class: 300 Product Weight (lbs.): 20 Cubic Feet Per Carton: 9.75</p>	<p>Upholstered Seat and Back. Use with beam.</p>	6930	512	546	575	616	676	703	757	842	908	981	1131	1291		
			<b>OVERALL DIMENSIONS</b>			<b>SEAT DIMENSIONS</b>			<b>BACK DIMENSIONS</b>							
			<b>W</b>	<b>D</b>	<b>H</b>	<b>W</b>	<b>D</b>	<b>H</b>	<b>W</b>	<b>H</b>						
			25.5	23.5	19	19.5	18	-	19	15.5						
			<b>RTA 00</b>													
 <p><b>Armless Seat Unit</b> COM Yardage: 1.25 Freight Class: 300 Product Weight (lbs.): 18 Cubic Feet Per Carton: 9.75</p>	<p>Upholstered Seat and Back. Use with beam.</p>	6931	468	503	532	573	632	660	713	798	865	938	1087	1248		
			<b>OVERALL DIMENSIONS</b>			<b>SEAT DIMENSIONS</b>			<b>BACK DIMENSIONS</b>							
			<b>W</b>	<b>D</b>	<b>H</b>	<b>W</b>	<b>D</b>	<b>H</b>	<b>W</b>	<b>H</b>						
			21	23.5	19	19.5	18	-	19	15.5						
			<b>RTA 00</b>													

SONIC™



model 6514MB



model 6515



model 6511TR



model 6524TR

STANDARD FEATURES

- Sonic series includes: beam seating, four-legged models, sled base models, tablet models, stools, caster models and task seating.
- Four-legged/freestanding models are standard with a straight leg or with a "WS" wall saver frame and durable polypropylene glides.
- WS models have a wall saver frame design; the base touches the wall before the upper back to protect the wall from damage.
- Four-legged/freestanding chairs are standard with Chrome (CH) legs.
- Models are available with or without arms. Arms available in Black only.
- Freestanding and Caster models are stackable up to 5 high on floor and 10 high on dolly 6517WS. **Tablet and Stool models do not stack.**
- Tablet arms are extremely rugged and meets ANSI-BIFMA testing requirements. Tablet hinges up to allow ease of egress. Tablet slides forward and back to accommodate any body size comfortably.
- Standard tablet (D8) size is 18" d x 14 1/2" w and is made of black polymer. Tablets are attached at the left or right (as seated). Please specify. Tablet arms are not available on stools.
- Sonic beam seating consists of upper seat units (models 6501, 6502, 6503, 6504, 6505, and 6506) including mounting brackets and all hardware necessary for attachment to beam.
- For all beam components, tables and a complete list of available upper seat units, see Beam Seating series.
- Task chairs standard with five prong, injection molded, fiberglass reinforced nylon Black spider base.
- (C1) dual wheel carpet casters are standard on any four-legged model with casters.
- (C65) dual wheel carpet casters are standard on models 6537, 6538, 6539, 6567, 6568 and 6569.

- Upholstery inserts are simple to replace for ease of on-site long term maintenance.
- Mesh back (MB) models are available in Black mesh only.
- **Specifications and pricing are for 1 chair.**

OPTIONAL FEATURES

- Polypropylene seats, backs and coordinating arms are available in 14 designer colors. Choose from Buzz Blue (BZB), Cactus (CCT), Carrot (CRO), Cloud (IVC), Dijon (DJN), Eggplant (EGP), Fog (FOG), Frost (FRO), Ink (INK), Latte (LAB), Night (BLK), Sand (SND), Scarlet (SAR), and Shadow (SHW).
- An optional 18 1/2"D x 18 1/2"W high pressure laminate writing tablet is available. The core is hardwood veneer plywood and the edge is bull nosed and finished in clear lacquer. This writing tablet is offered in the following finishes: Black (D1), Grey (D2), White (D4) and Tiger Maple (D5). Please specify. Add \$45 to list price on desired tablet model.
- Four Legged/Freestanding chairs are available in Black (BK) and Tungsten (TUN) frame finishes, at no up charge. Please Specify.
- For hard surface flooring, substitute C9R casters as an option. Please specify. Add \$41.
- Specify C65R for hard surface flooring on models 6537, 6538, 6539, 6567, 6568 and 6569.
- Opaque off-white non-marking glides for hard surface flooring are optional for guest chairs, please specify (NM). No upcharge.
- Optional steel cushioned glides (B) are available on model 6508, 6508-1, 6509, 6509-1, 6511, 6511-1, 6513, 6513-1, 6514, 6514-1, 6515, and 6515-1. Please specify and add \$23.
- Sonic models can be upholstered in fabric. Not available in Leather.

DESCRIPTION	FEATURES	MODEL#	STANDARD TEXTILE GRADES											
			1	2	3	4	5	6	7	8	9	10	11	12



**Book Rack**  
COM Yardage: N/A  
Freight Class: 250  
Product Weight (lbs.): 5  
Cubic Feet Per Carton: 1.40 (1 per carton)

Use with Tablet models.

6500BR	164	-	-	-	-	-	-	-	-	-	-	-	-
--------	-----	---	---	---	---	---	---	---	---	---	---	---	---

OVERALL DIMENSIONS			SEAT DIMENSIONS			BACK DIMENSIONS	
W	D	H	W	D	H	W	H

19.25	14.75	6	-	-	-	-	-
-------	-------	---	---	---	---	---	---

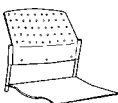

**Armless Seat Unit**  
COM Yardage: N/A  
Freight Class: 250  
Product Weight (lbs.): 12  
Cubic Feet Per Carton: 3.25 (2 per carton)











Polypropylene Seat and Back.  
Use with Beam.

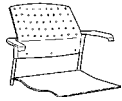

6501	301	-	-	-	-	-	-	-	-	-	-	-
------	-----	---	---	---	---	---	---	---	---	---	---	---

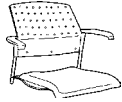

OVERALL DIMENSIONS			SEAT DIMENSIONS			BACK DIMENSIONS	
W	D	H	W	D	H	W	H



20	21.5	17	17	16	-	17	15
----	------	----	----	----	---	----	----





DESCRIPTION	FEATURES	MODEL#	STANDARD TEXTILE GRADES											
			1	2	3	4	5	6	7	8	9	10	11	12
 <b>Armless Seat Unit</b> COM Yardage: 0.75 Freight Class: 250 Product Weight (lbs.): 12 Cubic Feet Per Carton: 3.25 (2 per carton)	Upholstered Seat and Polypropylene Back. Use with Beam.	<b>6502</b>	337	358	373	397	433	443	475	531	558	611	683	774
			<b>OVERALL DIMENSIONS</b>			<b>SEAT DIMENSIONS</b>			<b>BACK DIMENSIONS</b>					
			<b>W</b>	<b>D</b>	<b>H</b>	<b>W</b>	<b>D</b>	<b>H</b>	<b>W</b>	<b>H</b>				
			20	22	17	17	16	-	17	15				
			<b>RTA 00</b>											
 <b>Armless Seat Unit</b> COM Yardage: 0.75 Freight Class: 150 Product Weight (lbs.): 13 Cubic Feet Per Carton: 3.25 (2 per carton)	Upholstered Seat and Back. Use with Beam.	<b>6503</b>	370	390	406	430	465	477	506	564	591	644	717	806
			<b>OVERALL DIMENSIONS</b>			<b>SEAT DIMENSIONS</b>			<b>BACK DIMENSIONS</b>					
			<b>W</b>	<b>D</b>	<b>H</b>	<b>W</b>	<b>D</b>	<b>H</b>	<b>W</b>	<b>H</b>				
			20	22	17	17	15.5	-	17	15				
			<b>RTA 00</b>											
 <b>Seat Unit w/Arms</b> COM Yardage: N/A Freight Class: 150 Product Weight (lbs.): 13 Cubic Feet Per Carton: 3.25 (2 per carton)	Polypropylene Seat and Back. Use with Beam.	<b>6504</b>	353	-	-	-	-	-	-	-	-	-	-	-
			<b>OVERALL DIMENSIONS</b>			<b>SEAT DIMENSIONS</b>			<b>BACK DIMENSIONS</b>					
			<b>W</b>	<b>D</b>	<b>H</b>	<b>W</b>	<b>D</b>	<b>H</b>	<b>W</b>	<b>H</b>				
			23	21.5	17	17	16	-	17	15				
			<b>RTA 00</b>											
 <b>Seat Unit w/Arms</b> COM Yardage: 0.75 Freight Class: 22. Product Weight (lbs.): 13 Cubic Feet Per Carton: 3.25 (2 per carton)	Upholstered Seat and Polypropylene Back. Use with Beam.	<b>6505</b>	387	406	423	446	482	492	524	579	607	660	733	823
			<b>OVERALL DIMENSIONS</b>			<b>SEAT DIMENSIONS</b>			<b>BACK DIMENSIONS</b>					
			<b>W</b>	<b>D</b>	<b>H</b>	<b>W</b>	<b>D</b>	<b>H</b>	<b>W</b>	<b>H</b>				
			23	22	17	17	16	-	17	15				
			<b>RTA 00</b>											
 <b>Seat Unit w/Arms</b> COM Yardage: 0.75 Freight Class: 150 Product Weight (lbs.): 14 Cubic Feet Per Carton: 3.25 (2 per carton)	Upholstered Seat and Back. Use with Beam.	<b>6506</b>	418	439	455	479	514	526	556	613	641	694	767	855
			<b>OVERALL DIMENSIONS</b>			<b>SEAT DIMENSIONS</b>			<b>BACK DIMENSIONS</b>					
			<b>W</b>	<b>D</b>	<b>H</b>	<b>W</b>	<b>D</b>	<b>H</b>	<b>W</b>	<b>H</b>				
			23	22	17	17	16	-	17	15				
			<b>RTA 00</b>											









DESCRIPTION	FEATURES	MODEL#	STANDARD TEXTILE GRADES														
			1	2	3	4	5	6	7	8	9	10	11	12			
 6508	 6508MB (Mesh back)	6508	231	-	-	-	-	-	-	-	-	-	-	-			
		6508WS	254	-	-	-	-	-	-	-	-	-	-	-	-		
			6508MB	277	-	-	-	-	-	-	-	-	-	-			
			6508WSMB	299	-	-	-	-	-	-	-	-	-	-			
			<b>OVERALL DIMENSIONS</b>			<b>SEAT DIMENSIONS</b>			<b>BACK DIMENSIONS</b>								
			<b>W</b>	<b>D</b>	<b>H</b>	<b>W</b>	<b>D</b>	<b>H</b>	<b>W</b>	<b>H</b>							
<p><b>Armless Chair</b> COM Yardage: N/A Freight Class: 250 Product Weight (lbs.): 10 Cubic Feet Per Carton: 13.5 (2 per carton)</p>			<p>Polypropylene Seat. Stacks 5 high on floor. Stacks 10 high on dolly.</p>			<p><b>RTA 00</b></p>											
			21.5	21.5	33	17	16	18	17	15							

DESCRIPTION	FEATURES	MODEL#	STANDARD TEXTILE GRADES														
			1	2	3	4	5	6	7	8	9	10	11	12			
 6508TR	 6508TRMB (Mesh back)	6508T	462	-	-	-	-	-	-	-	-	-	-	-			
		6508TWS	487	-	-	-	-	-	-	-	-	-	-	-	-		
			6508TMB	505	-	-	-	-	-	-	-	-	-	-			
			6508TWSMB	528	-	-	-	-	-	-	-	-	-	-			
			<b>OVERALL DIMENSIONS</b>			<b>SEAT DIMENSIONS</b>			<b>BACK DIMENSIONS</b>								
			<b>W</b>	<b>D</b>	<b>H</b>	<b>W</b>	<b>D</b>	<b>H</b>	<b>W</b>	<b>H</b>							
<p><b>Armless Chair w/Tablet</b> COM Yardage: N/A Freight Class: 250 Product Weight (lbs.): 26 Cubic Feet Per Carton: 14.25 (1 per carton)</p>			<p>Polypropylene Seat. Does not stack. <b>Must specify (L) Left or (R) Right Tablet</b> (Example: 6508TL or 6508TR)</p>			<p><b>RTA 00</b></p>											
			24.75	26.5	32.5	17	16	18	17	15							

DESCRIPTION	FEATURES	MODEL#	STANDARD TEXTILE GRADES														
			1	2	3	4	5	6	7	8	9	10	11	12			
 6509	 6509MB (Mesh Back)	6509	267	288	302	328	361	373	404	461	486	538	607	698			
		6509MB	312	332	348	371	406	417	449	505	532	585	658	748			
			6509WS	312	330	346	371	404	415	445	501	527	578	649	740		
			6509WSMB	337	358	373	397	433	443	475	532	558	611	683	774		
			<b>OVERALL DIMENSIONS</b>			<b>SEAT DIMENSIONS</b>			<b>BACK DIMENSIONS</b>								
			<b>W</b>	<b>D</b>	<b>H</b>	<b>W</b>	<b>D</b>	<b>H</b>	<b>W</b>	<b>H</b>							
<p><b>Armless Chair</b> COM Yardage: 0.75 Freight Class: 300 Product Weight (lbs.): 10 Cubic Feet Per Carton: 13.5 (2 per carton)</p>			<p>Upholstered Seat. Stacks 5 high on floor. Stacks 10 high on dolly.</p>			<p><b>RTA 00</b></p>											
			21.5	22	33	17	16	18.5	17	15							

DESCRIPTION	FEATURES	MODEL#	STANDARD TEXTILE GRADES														
			1	2	3	4	5	6	7	8	9	10	11	12			
 6509TR	 6509TRMB (Mesh back)	6509T	495	517	534	560	596	609	642	703	733	789	866	961			
		6509TWS	519	540	558	585	621	633	666	727	757	813	889	986			
			6509TMB	536	558	575	601	637	650	683	744	774	831	907	1004		
			6509TWSMB	560	581	599	626	662	675	707	769	798	854	932	1027		
			<b>OVERALL DIMENSIONS</b>			<b>SEAT DIMENSIONS</b>			<b>BACK DIMENSIONS</b>								
			<b>W</b>	<b>D</b>	<b>H</b>	<b>W</b>	<b>D</b>	<b>H</b>	<b>W</b>	<b>H</b>							
<p><b>Armless Chair w/Tablet</b> COM Yardage: 0.75 Freight Class: 250 Product Weight (lbs.): 28 Cubic Feet Per Carton: 14.25 (1 per carton)</p>			<p>Upholstered Seat. Does not stack. <b>Must specify (L) Left or (R) Right Tablet</b> (Example: 6509TL or 6509TR)</p>			<p><b>RTA 00</b></p>											
			24.75	26.5	32.5	17	16	18.5	17	15							

DESCRIPTION	FEATURES	MODEL#	STANDARD TEXTILE GRADES														
			1	2	3	4	5	6	7	8	9	10	11	12			
 6511		6511	300	321	338	361	395	406	436	492	518	572	641	730			
		6511WS	321	341	358	381	415	427	457	513	539	590	662	751			
			<b>OVERALL DIMENSIONS</b>			<b>SEAT DIMENSIONS</b>			<b>BACK DIMENSIONS</b>								
			<b>W</b>	<b>D</b>	<b>H</b>	<b>W</b>	<b>D</b>	<b>H</b>	<b>W</b>	<b>H</b>							
<p><b>Armless Chair</b> COM Yardage: 0.75 Freight Class: 300 Product Weight (lbs.): 11 Cubic Feet Per Carton: 13.5 (2 per carton)</p>			<p>Upholstered Seat and Back. Stacks 5 high on floor. Stacks 10 high on dolly.</p>			<p><b>RTA 00</b></p>											
			21.5	21.5	32	17	16	18.5	17	15							

DESCRIPTION	FEATURES	MODEL#	STANDARD TEXTILE GRADES											
			1	2	3	4	5	6	7	8	9	10	11	12
 <p><b>6511TR</b></p> <p><b>Armless Chair w/Tablet</b> COM Yardage: 0.75 Freight Class: 250 Product Weight (lbs.): 28 Cubic Feet Per Carton: 14.25 (1 per carton)</p>	<p>Upholstered Seat &amp; Back. Does not stack. <b>Must specify (L) Left or (R) Right Tablet</b> <b>(Example: 6511TL or 6511TR)</b></p>	<p><b>6511T</b> 533 555 572 598 634 647 680 741 771 828 904 1000 <b>6511TWS</b> 557 578 596 623 659 671 704 765 795 851 927 1024</p>	<b>OVERALL DIMENSIONS</b>			<b>SEAT DIMENSIONS</b>			<b>BACK DIMENSIONS</b>					
			<b>W</b>	<b>D</b>	<b>H</b>	<b>W</b>	<b>D</b>	<b>H</b>	<b>W</b>	<b>H</b>				
			24.75	26.5	32.5	17	16	18.5	17	15				
			<b>RTA 00</b>											
 <p><b>6513</b></p>	 <p><b>6513MB (Mesh Back)</b></p>	<p><b>6513</b> 282 - - - - - - - - - - - - <b>6513WS</b> 312 - - - - - - - - - - - - <b>6513MB</b> 326 - - - - - - - - - - - - <b>6513WSMB</b> 356 - - - - - - - - - - - -</p>	<b>OVERALL DIMENSIONS</b>			<b>SEAT DIMENSIONS</b>			<b>BACK DIMENSIONS</b>					
			<b>W</b>	<b>D</b>	<b>H</b>	<b>W</b>	<b>D</b>	<b>H</b>	<b>W</b>	<b>H</b>				
			23	21.5	33	17	16	18	17	15				
			<b>RTA 00</b>											
 <p><b>6513TR</b></p>	 <p><b>6513TRMB (Mesh back)</b></p>	<p><b>6513T</b> 518 - - - - - - - - - - - - <b>6513TWS</b> 542 - - - - - - - - - - - - <b>6513TMB</b> 525 - - - - - - - - - - - - <b>6513TWSMB</b> 548 - - - - - - - - - - - -</p>	<b>OVERALL DIMENSIONS</b>			<b>SEAT DIMENSIONS</b>			<b>BACK DIMENSIONS</b>					
			<b>W</b>	<b>D</b>	<b>H</b>	<b>W</b>	<b>D</b>	<b>H</b>	<b>W</b>	<b>H</b>				
			25	26.5	32.5	17	16	18	17	15				
			<b>RTA 00</b>											
 <p><b>6514</b></p>	 <p><b>6514MB (Mesh Back)</b></p>	<p><b>6514</b> 315 334 350 374 408 418 450 505 531 582 654 743 <b>6514WS</b> 338 358 373 398 431 441 472 528 555 606 677 767 <b>6514MB</b> 362 385 400 425 460 470 501 558 585 637 709 800 <b>6514WSMB</b> 392 400 416 440 476 487 517 574 601 654 727 816</p>	<b>OVERALL DIMENSIONS</b>			<b>SEAT DIMENSIONS</b>			<b>BACK DIMENSIONS</b>					
			<b>W</b>	<b>D</b>	<b>H</b>	<b>W</b>	<b>D</b>	<b>H</b>	<b>W</b>	<b>H</b>				
			23	22	33	17	16	18.5	17	15				
			<b>RTA 00</b>											
 <p><b>6514TR</b></p>	 <p><b>6514TRMB (Mesh back)</b></p>	<p><b>6514T</b> 552 573 591 616 652 666 699 760 789 846 922 1018 <b>6514TWS</b> 575 597 614 641 677 690 723 784 813 870 946 1043 <b>6514TMB</b> 554 575 593 618 655 668 701 762 792 848 924 1021 <b>6514TWSMB</b> 576 598 615 642 678 691 724 785 814 871 948 1044</p>	<b>OVERALL DIMENSIONS</b>			<b>SEAT DIMENSIONS</b>			<b>BACK DIMENSIONS</b>					
			<b>W</b>	<b>D</b>	<b>H</b>	<b>W</b>	<b>D</b>	<b>H</b>	<b>W</b>	<b>H</b>				
			25	26.5	32.5	17	16	18.5	17	15				
			<b>RTA 00</b>											





DESCRIPTION	FEATURES	MODEL#	STANDARD TEXTILE GRADES											
			1	2	3	4	5	6	7	8	9	10	11	12
 <b>6515</b>	Upholstered Seat and Back. Stacks 5 high on floor. Stacks 10 high on dolly.	<b>6515</b>	345	364	380	405	437	450	480	536	561	613	683	774
		<b>6515WS</b>	370	389	405	430	463	473	503	560	587	637	707	799
<b>OVERALL DIMENSIONS</b>			<b>SEAT DIMENSIONS</b>			<b>BACK DIMENSIONS</b>								
W D H			W D H			W H								
23 22 34			17 15.5 18.5			17 15								
<b>RTA 00</b>														

**Armchair**  
COM Yardage: 0.75  
Freight Class: 300  
Product Weight (lbs.): 11.50  
Cubic Feet Per Carton: 5.88 (2 per carton)

DESCRIPTION	FEATURES	MODEL#	STANDARD TEXTILE GRADES											
			1	2	3	4	5	6	7	8	9	10	11	12
 <b>6515TR</b>	Upholstered Seat & Back. Does not stack. <b>Must specify (L) Left or (R) Right Tablet</b> <b>(Example: 6515TL or 6515TR)</b>	<b>6515T</b>	552	605	623	648	684	698	731	792	821	878	954	1050
		<b>6515TWS</b>	606	628	645	671	707	720	753	814	844	901	977	1073
<b>OVERALL DIMENSIONS</b>			<b>SEAT DIMENSIONS</b>			<b>BACK DIMENSIONS</b>								
W D H			W D H			W H								
25 26.5 32.5			17 16 18			17 15								
<b>RTA 00</b>														

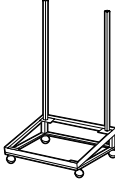
**Armchair w/Tablet**  
COM Yardage: 0.75  
Freight Class: 250  
Product Weight (lbs.): 30  
Cubic Feet Per Carton: 14.25 (1 per carton)

DESCRIPTION	FEATURES	MODEL#	STANDARD TEXTILE GRADES											
			1	2	3	4	5	6	7	8	9	10	11	12
 <b>6517WS</b>	Accommodates 10 chairs.	<b>6517WS</b>	402	-	-	-	-	-	-	-	-	-	-	-
<b>OVERALL DIMENSIONS</b>			<b>SEAT DIMENSIONS</b>			<b>BACK DIMENSIONS</b>								
W D H			W D H			W H								
23.25 24.75 12.25			-			-								
<b>RTA 1</b> 														









**Dolly - Wall Saver**  
COM Yardage: N/A  
Freight Class: 150  
Product Weight (lbs.): 20  
Cubic Feet Per Carton: 4 (0.5 per carton)



DESCRIPTION	FEATURES	MODEL#	STANDARD TEXTILE GRADES											
			1	2	3	4	5	6	7	8	9	10	11	12
 <b>6518</b>	Polypropylene Seat. Stacks 5 high on floor. Stacks 10 high on dolly.	<b>6518</b>	278	-	-	-	-	-	-	-	-	-	-	-
		<b>6518WS</b>	302	-	-	-	-	-	-	-	-	-	-	-
		<b>6518MB</b>	324	-	-	-	-	-	-	-	-	-	-	-
		<b>6518WSMB</b>	351	-	-	-	-	-	-	-	-	-	-	-
<b>OVERALL DIMENSIONS</b>			<b>SEAT DIMENSIONS</b>			<b>BACK DIMENSIONS</b>								
W D H			W D H			W H								
22 21 32.5			17 16 17			17 15								
<b>RTA 00</b>														



**Armless Chair w/Sled Base**  
COM Yardage: N/A  
Freight Class: 250  
Product Weight (lbs.): 14  
Cubic Feet Per Carton: 11.75 (2 per carton)





DESCRIPTION	FEATURES	MODEL#	STANDARD TEXTILE GRADES											
			1	2	3	4	5	6	7	8	9	10	11	12
 <b>6518TR</b>	Polypropylene Seat. Does not stack. <b>Must specify (L) Left or (R) Right Tablet</b> <b>(Example: 6518TL or 6518TR)</b>	<b>6518T</b>	514	-	-	-	-	-	-	-	-	-	-	-
		<b>6518TWS</b>	539	-	-	-	-	-	-	-	-	-	-	-
		<b>6518TMB</b>	552	-	-	-	-	-	-	-	-	-	-	-
		<b>6518TWSMB</b>	576	-	-	-	-	-	-	-	-	-	-	-
<b>OVERALL DIMENSIONS</b>			<b>SEAT DIMENSIONS</b>			<b>BACK DIMENSIONS</b>								
W D H			W D H			W H								
24.75 26.5 32.5			17 16 18			17 15								
<b>RTA 00</b>														



**Armless Chair w/Tablet and Sled Base**  
COM Yardage: N/A  
Freight Class: 300  
Product Weight (lbs.): 26  
Cubic Feet Per Carton: 14.25 (1 per carton)



DESCRIPTION	FEATURES	MODEL#	STANDARD TEXTILE GRADES												
			1	2	3	4	5	6	7	8	9	10	11	12	
 6519	 6519MB (Mesh Back)		6519	313	332	348	372	405	416	446	502	528	579	650	741
			6519WS	342	364	381	405	440	452	482	539	566	618	692	780
			6519MB	358	379	395	418	454	465	497	553	579	632	705	795
			6519WSMB	388	408	425	449	483	494	525	580	608	662	734	824
			OVERALL DIMENSIONS			SEAT DIMENSIONS			BACK DIMENSIONS						
			W	D	H	W	D	H	W	H					
			22	21	33	17	16	17	17	15					
			RTA 00												
 6519TR	 6519TRMB (Mesh back)		6519T	544	567	585	610	646	660	692	753	782	840	916	1012
			6519TWS	564	587	604	630	666	679	712	773	803	860	936	1032
			6519TMB	586	607	625	650	686	700	733	794	823	880	956	1052
			6519TWSMB	647	673	709	723	755	816	846	903	979	1076	979	1052
			OVERALL DIMENSIONS			SEAT DIMENSIONS			BACK DIMENSIONS						
			W	D	H	W	D	H	W	H					
			24.5	26.5	32.5	17	16	18	17	15					
			RTA 00												
 6521			6521	341	361	377	403	435	446	477	532	558	609	681	771
			6521WS	367	387	402	425	458	469	498	553	577	629	697	782
			OVERALL DIMENSIONS			SEAT DIMENSIONS			BACK DIMENSIONS						
			W	D	H	W	D	H	W	H					
			22	21	33	17	16	18.5	17	15					
			RTA 00												
 6521TR			6521T	546	569	587	612	648	662	695	755	785	842	918	1014
			6521TWS	567	589	606	632	668	681	714	775	805	862	938	1034
			OVERALL DIMENSIONS			SEAT DIMENSIONS			BACK DIMENSIONS						
			W	D	H	W	D	H	W	H					
			24.75	26.5	32.5	17	16	18.5	17	15					
			RTA 00												
 6523	 6523MB (Mesh Back)		6523	322	-	-	-	-	-	-	-	-	-	-	
			6523WS	356	-	-	-	-	-	-	-	-	-	-	-
			6523MB	377	-	-	-	-	-	-	-	-	-	-	
			6523WSMB	395	-	-	-	-	-	-	-	-	-	-	
			OVERALL DIMENSIONS			SEAT DIMENSIONS			BACK DIMENSIONS						
			W	D	H	W	D	H	W	H					
			23	21	32.5	17	16	17	17	15					
			RTA 00												
<p><b>Armless Chair w/Sled Base</b> COM Yardage: 0.75 Freight Class: 250 Product Weight (lbs.): 14 Cubic Feet Per Carton: 13.5 (2 per carton)</p>	<p>Upholstered Seat. Stacks 5 high on floor. Stacks 10 high on dolly.</p>														
<p><b>Armless Chair w/Tablet and Sled Base</b> COM Yardage: 0.75 Freight Class: 300 Product Weight (lbs.): 28 Cubic Feet Per Carton: 14.25 (1 per carton)</p>	<p>Upholstered Seat. Does not stack. <b>Must specify (L) Left or (R) Right Tablet</b> (Example: 6519TL or 6519TR)</p>														
<p><b>Armless Chair w/Sled Base</b> COM Yardage: 0.75 Freight Class: 250 Product Weight (lbs.): 15 Cubic Feet Per Carton: 13.5 (2 per carton)</p>	<p>Upholstered Seat and Back. Stacks 5 high on floor. Stacks 10 high on dolly.</p>														
<p><b>Armless Chair w/Tablet and Sled Base</b> COM Yardage: 0.75 Freight Class: 300 Product Weight (lbs.): 29 Cubic Feet Per Carton: 14.25 (1 per carton)</p>	<p>Upholstered Seat &amp; Back. Does not stack. <b>Must specify (L) Left or (R) Right Tablet</b> (Example: 6521TL or 6521TR)</p>														
<p><b>Armchair w/Sled Base</b> COM Yardage: N/A Freight Class: 250 Product Weight (lbs.): 15 Cubic Feet Per Carton: 13.5 (2 per carton)</p>	<p>Polypropylene Seat. Stacks 5 high on floor. Stacks 10 high on dolly.</p>														



DESCRIPTION	FEATURES	MODEL#	STANDARD TEXTILE GRADES											
			1	2	3	4	5	6	7	8	9	10	11	12
 6523TR	 6523TRMB (Mesh back)	6523T	567	-	-	-	-	-	-	-	-	-	-	
		6523TWS	592	-	-	-	-	-	-	-	-	-	-	-
			6523TMB	608	-	-	-	-	-	-	-	-	-	
			6523TWSMB	632	-	-	-	-	-	-	-	-	-	
			<b>OVERALL DIMENSIONS</b>			<b>SEAT DIMENSIONS</b>			<b>BACK DIMENSIONS</b>					
			<b>W</b>	<b>D</b>	<b>H</b>	<b>W</b>	<b>D</b>	<b>H</b>	<b>W</b>	<b>H</b>				
			25	26.5	32.5	17	16	18	17	15				
<b>Armchair w/Tablet and Sled Base</b> COM Yardage: N/A Freight Class: 300 Product Weight (lbs.): 27 Cubic Feet Per Carton: 14.25 (1 per carton)			Polypropylene Seat. Does not stack. <b>Must specify (L) Left or (R) Right Tablet</b> (Example: 6523TL or 6523TR)											



DESCRIPTION	FEATURES	MODEL#	STANDARD TEXTILE GRADES												
			1	2	3	4	5	6	7	8	9	10	11	12	
 6524	 6524MB (Mesh Back)	6524	356	376	391	416	450	462	491	548	574	626	696	785	
		6524WS	400	421	436	461	497	506	537	595	623	675	748	836	
			6524MB	412	433	450	473	507	519	551	606	633	685	760	849
			6524WSMB	443	464	480	504	539	552	580	639	666	718	792	881
			<b>OVERALL DIMENSIONS</b>			<b>SEAT DIMENSIONS</b>			<b>BACK DIMENSIONS</b>						
			<b>W</b>	<b>D</b>	<b>H</b>	<b>W</b>	<b>D</b>	<b>H</b>	<b>W</b>	<b>H</b>					
			33	21	33	17	16	17.5	17	15					
<b>Armchair w/Sled Base</b> COM Yardage: 0.75 Freight Class: 250 Product Weight (lbs.): 15 Cubic Feet Per Carton: 13.5 (2 per carton)			Upholstered Seat. Stacks 5 high on floor. Stacks 10 high on dolly.												

DESCRIPTION	FEATURES	MODEL#	STANDARD TEXTILE GRADES												
			1	2	3	4	5	6	7	8	9	10	11	12	
 6524TR	 6524TRMB (Mesh back)	6524T	596	617	635	662	698	710	743	805	834	890	968	1063	
		6524TWS	618	641	659	684	720	734	767	828	857	914	990	1086	
			6524TMB	595	616	634	661	697	709	742	804	832	888	967	1062
			6524TWSMB	617	640	658	683	719	733	765	827	855	913	989	1085
			<b>OVERALL DIMENSIONS</b>			<b>SEAT DIMENSIONS</b>			<b>BACK DIMENSIONS</b>						
			<b>W</b>	<b>D</b>	<b>H</b>	<b>W</b>	<b>D</b>	<b>H</b>	<b>W</b>	<b>H</b>					
			25	26.5	32.5	17	16	18.5	17	15					
<b>Armchair w/Tablet and Sled Base</b> COM Yardage: 0.75 Freight Class: 300 Product Weight (lbs.): 29 Cubic Feet Per Carton: 13.5 (1 per carton)			Upholstered Seat. Does not stack. <b>Must specify (L) Left or (R) Right Tablet</b> (Example: 6524TL or 6524TR)			 									

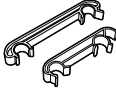

DESCRIPTION	FEATURES	MODEL#	STANDARD TEXTILE GRADES												
			1	2	3	4	5	6	7	8	9	10	11	12	
 6525			6525	388	408	425	449	482	492	524	578	605	658	727	816
			6525WS	427	446	463	487	523	533	563	623	648	701	774	863
			<b>OVERALL DIMENSIONS</b>			<b>SEAT DIMENSIONS</b>			<b>BACK DIMENSIONS</b>						
			<b>W</b>	<b>D</b>	<b>H</b>	<b>W</b>	<b>D</b>	<b>H</b>	<b>W</b>	<b>H</b>					
			23	21	33	17	15.5	17.5	17	15					
<b>Armchair</b> COM Yardage: 0.75 Freight Class: 250 Product Weight (lbs.): 16 Cubic Feet Per Carton: 13.5 (2 per carton)			Upholstered Seat and Back. Stacks 5 high on floor. Stacks 10 high on dolly.												

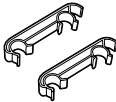
DESCRIPTION	FEATURES	MODEL#	STANDARD TEXTILE GRADES												
			1	2	3	4	5	6	7	8	9	10	11	12	
 6525TR			6525T	622	643	661	686	723	736	769	830	860	916	992	1088
			6525TWS	645	667	684	710	746	760	793	853	883	940	1016	1113
			<b>OVERALL DIMENSIONS</b>			<b>SEAT DIMENSIONS</b>			<b>BACK DIMENSIONS</b>						
			<b>W</b>	<b>D</b>	<b>H</b>	<b>W</b>	<b>D</b>	<b>H</b>	<b>W</b>	<b>H</b>					
			25	26.5	32.5	17	16	18.5	17	15					
<b>Armchair w/Tablet and Sled Base</b> COM Yardage: 0.75 Freight Class: 300 Product Weight (lbs.): 30 Cubic Feet Per Carton: 14.25 (1 per carton)			Upholstered Seat & Back. Does not stack. <b>Must specify (L) Left or (R) Right Tablet</b> (Example: 6525TL or 6525TR)			 									

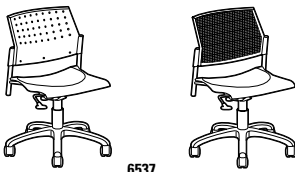

DESCRIPTION	FEATURES	MODEL#	STANDARD TEXTILE GRADES											
			1	2	3	4	5	6	7	8	9	10	11	12
 <p><b>Ganging Brackets</b> COM Yardage: N/A Freight Class: 70 Product Weight (lbs.): 0.2 Cubic Feet Per Carton: 1 (25 per carton)</p>	For four legged models only.	6522	22	-	-	-	-	-	-	-	-	-	-	-
		<b>OVERALL DIMENSIONS</b>			<b>SEAT DIMENSIONS</b>			<b>BACK DIMENSIONS</b>						
		<b>W</b>	<b>D</b>	<b>H</b>	<b>W</b>	<b>D</b>	<b>H</b>	<b>W</b>	<b>H</b>					
		0.87	7.75	1.5	-	-	-	-	-					
			<b>RTA 00</b>											



DESCRIPTION	FEATURES	MODEL#	STANDARD TEXTILE GRADES											
			1	2	3	4	5	6	7	8	9	10	11	12
 <p><b>Ganging Brackets</b> COM Yardage: N/A Freight Class: 70 Product Weight (lbs.): 0.25 Cubic Feet Per Carton: 1 (25 per carton)</p>	Sled base models only.	6526	17	-	-	-	-	-	-	-	-	-	-	-
		<b>OVERALL DIMENSIONS</b>			<b>SEAT DIMENSIONS</b>			<b>BACK DIMENSIONS</b>						
		<b>W</b>	<b>D</b>	<b>H</b>	<b>W</b>	<b>D</b>	<b>H</b>	<b>W</b>	<b>H</b>					
		0.75	5.75	1.25	-	-	-	-	-					
			<b>RTA 00</b>											



DESCRIPTION	FEATURES	MODEL#	STANDARD TEXTILE GRADES											
			1	2	3	4	5	6	7	8	9	10	11	12
 <p><b>Armless LB Task</b> COM Yardage: N/A Freight Class: 250 Product Weight (lbs.): 21.50 Cubic Feet Per Carton: 6.50</p>	<p>Polypropylene seat. Ergonomic features: C</p> <p><b>ADJUSTMENTS</b> (2) Pneumatic seat height</p>	6537	375											
		6537T	663											
		6537MB	422											
		6537MBT	712											
<b>Available with tablet:</b> Specify (L) left or (R) right tablet. (Example: 6537TL or 6537TR).			<b>RTA 1</b>	1 per carton										
<b>OVERALL DIMENSIONS</b>			<b>SEAT DIMENSIONS</b>			<b>BACK DIMENSIONS</b>								
<b>W</b>	<b>D</b>	<b>H</b>	<b>W</b>	<b>D</b>	<b>H</b>	<b>W</b>	<b>H</b>							
20.5	20.5	32.5	17	16	15.5-19.5	17	15							



DESCRIPTION	FEATURES	MODEL#	STANDARD TEXTILE GRADES											
			1	2	3	4	5	6	7	8	9	10	11	12
 <p><b>Armless LB Task</b> COM Yardage: .75 Freight Class: 250 Product Weight (lbs.): 22.50 Cubic Feet Per Carton: 6.50</p>	<p>Upholstered seat. Ergonomic features: C</p> <p><b>ADJUSTMENTS</b> (2) Pneumatic seat height</p>	6538	406	427	441	466	500	512	541	599	625	676	745	835
		6538T	686	709	728	755	794	811	846	902	945	992	1090	1195
		6538MB	457	477	492	517	553	563	594	650	678	731	804	894
		6538MBT	743	768	786	813	852	871	907	964	1008	1057	1156	1263
<b>Available with tablet:</b> Specify (L) left or (R) right tablet. (Example: 6538TL or 6538TR).			<b>RTA 1</b>	 1 per carton										
<b>OVERALL DIMENSIONS</b>			<b>SEAT DIMENSIONS</b>			<b>BACK DIMENSIONS</b>								
<b>W</b>	<b>D</b>	<b>H</b>	<b>W</b>	<b>D</b>	<b>H</b>	<b>W</b>	<b>H</b>							
20.5	20.5	32.5	17	16	16-20	17	14.5							

DESCRIPTION	FEATURES	MODEL#	STANDARD TEXTILE GRADES											
			1	2	3	4	5	6	7	8	9	10	11	12
 <p><b>Armless LB Task</b> COM Yardage: 6.50 Freight Class: 250 Product Weight (lbs.): 23.50 Cubic Feet Per Carton: 6.50</p>	<p>Upholstered seat &amp; back. Ergonomic features: C</p> <p><b>ADJUSTMENTS</b> (2) Pneumatic seat height</p>	6539	437	458	473	499	531	542	574	630	655	706	777	867
		6539T	715	738	755	782	821	839	873	927	971	1017	1115	1218
		<b>OVERALL DIMENSIONS</b>			<b>SEAT DIMENSIONS</b>			<b>BACK DIMENSIONS</b>						
		<b>W</b>	<b>D</b>	<b>H</b>	<b>W</b>	<b>D</b>	<b>H</b>	<b>W</b>	<b>H</b>					
20.5	20.5	33	17	15.5	16-20	17	15							
<b>Available with tablet:</b> Specify (L) left or (R) right tablet. (Example: 6539TL or 6539TR).			<b>RTA 1</b>	1 per carton										

DESCRIPTION	FEATURES	MODEL#	STANDARD TEXTILE GRADES											
			1	2	3	4	5	6	7	8	9	10	11	12
 <p><b>6558</b></p> <p><b>Armless Bar Stool</b> COM Yardage: N/A Freight Class: 300 Product Weight (lbs.): 18 Cubic Feet Per Carton: 14.75 (1 per carton)</p>	 <p><b>6558MB (Mesh Back)</b></p> <p>Polypropylene Seat. Stacks 5 high on floor.</p>													
		6558	361	-	-	-	-	-	-	-	-	-	-	-
		6558MB	422	-	-	-	-	-	-	-	-	-	-	
<b>OVERALL DIMENSIONS</b>			<b>SEAT DIMENSIONS</b>			<b>BACK DIMENSIONS</b>								
<b>W D H</b>			<b>W D H</b>			<b>W H</b>								
22 23 42			17 16 28			17 15								
<b>RTA 00</b>														

DESCRIPTION	FEATURES	MODEL#	STANDARD TEXTILE GRADES											
			1	2	3	4	5	6	7	8	9	10	11	12
 <p><b>6558CS</b></p> <p><b>Armless Counter Stool</b> COM Yardage: N/A Freight Class: 300 Product Weight (lbs.): 20 Cubic Feet Per Carton: 14.5 (1 per carton)</p>	 <p><b>6558CSMB (Mesh Back)</b></p> <p>Polypropylene Seat. Stacks 5 high on floor.</p>													
		6558CS	361	-	-	-	-	-	-	-	-	-	-	-
		6558CSMB	422	-	-	-	-	-	-	-	-	-	-	
<b>OVERALL DIMENSIONS</b>			<b>SEAT DIMENSIONS</b>			<b>BACK DIMENSIONS</b>								
<b>W D H</b>			<b>W D H</b>			<b>W H</b>								
22.5 22 38			17 16 24			17 15								
<b>RTA 00</b>														

DESCRIPTION	FEATURES	MODEL#	STANDARD TEXTILE GRADES											
			1	2	3	4	5	6	7	8	9	10	11	12
 <p><b>6559</b></p> <p><b>Armless Bar Stool</b> COM Yardage: 0.75 Freight Class: 300 Product Weight (lbs.): 18 Cubic Feet Per Carton: 14.75 (1 per carton)</p>	 <p><b>6559MB (Mesh Back)</b></p> <p>Upholstered Seat. Stacks 5 high on floor.</p>													
		6559	393	414	430	454	487	499	528	585	609	663	732	821
		6559MB	440	461	477	501	536	548	577	634	662	715	788	877
<b>OVERALL DIMENSIONS</b>			<b>SEAT DIMENSIONS</b>			<b>BACK DIMENSIONS</b>								
<b>W D H</b>			<b>W D H</b>			<b>W H</b>								
22 23 42			17 16 28.5			17 15								
<b>RTA 00</b>														



DESCRIPTION	FEATURES	MODEL#	STANDARD TEXTILE GRADES											
			1	2	3	4	5	6	7	8	9	10	11	12
 <p><b>6559CS</b></p> <p><b>Armless Counter Stool</b> COM Yardage: 0.75 Freight Class: 300 Product Weight (lbs.): 24 Cubic Feet Per Carton: 14.5 (1 per carton)</p>	 <p><b>6559CSMB (Mesh Back)</b></p> <p>Upholstered Seat. Stacks 5 high on floor.</p>													
		6559CS	393	414	430	454	487	499	528	585	609	663	732	821
		6559CSMB	440	461	477	501	536	548	577	634	662	715	788	877
<b>OVERALL DIMENSIONS</b>			<b>SEAT DIMENSIONS</b>			<b>BACK DIMENSIONS</b>								
<b>W D H</b>			<b>W D H</b>			<b>W H</b>								
22.5 22 38			17 16 24.5			17 15								

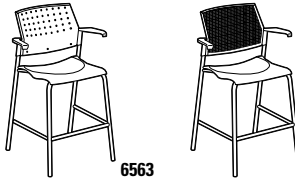
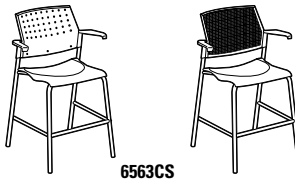
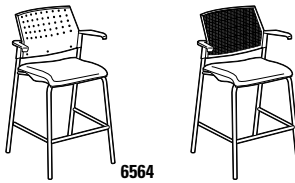
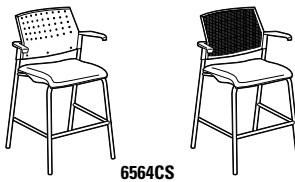

DESCRIPTION	FEATURES	MODEL#	STANDARD TEXTILE GRADES											
			1	2	3	4	5	6	7	8	9	10	11	12
 <p><b>6561</b></p> <p><b>Armless Bar Stool</b> COM Yardage: 0.75 Freight Class: 300 Product Weight (lbs.): 18 Cubic Feet Per Carton: 14.75 (1 per carton)</p>	<p>Upholstered Seat and back. Stacks 5 high on floor. Stacks 10 high on dolly.</p>													
		6561	427	446	463	487	522	531	561	617	644	696	767	857
<b>OVERALL DIMENSIONS</b>			<b>SEAT DIMENSIONS</b>			<b>BACK DIMENSIONS</b>								
<b>W D H</b>			<b>W D H</b>			<b>W H</b>								
22 23 42.5			17 16 28.5			17 15								
<b>RTA 00</b>														



DESCRIPTION	FEATURES	MODEL#	STANDARD TEXTILE GRADES												
			1	2	3	4	5	6	7	8	9	10	11	12	
 <p><b>Armless Counter Stool</b> COM Yardage: 0.75 Freight Class: 300 Product Weight (lbs.): 27 Cubic Feet Per Carton: 14.75 (1 per carton)</p>	<p>Upholstered Seat and back. Stacks 5 high on floor.</p>	<b>6561CS</b>	427	446	463	487	522	531	561	617	644	696	767	857	
			<b>OVERALL DIMENSIONS</b>			<b>SEAT DIMENSIONS</b>			<b>BACK DIMENSIONS</b>						
			<b>W</b>	<b>D</b>	<b>H</b>	<b>W</b>	<b>D</b>	<b>H</b>	<b>W</b>	<b>H</b>					
			22.5	22	38	17	16	24.5	17	15					
			<b>RTA 00</b>												
 <p><b>6563</b>      <b>6563MB</b> (Mesh Back)</p> <p><b>Bar Stool w/Arms</b> COM Yardage: N/A Freight Class: 300 Product Weight (lbs.): 19 Cubic Feet Per Carton: 14.75 (1 per carton)</p>	<p>Polypropylene Seat. Stacks 5 high on floor. Stacks 10 high on dolly.</p>	<b>6563</b>	411	-	-	-	-	-	-	-	-	-	-	-	
			<b>6563MB</b> Mesh Back	473	-	-	-	-	-	-	-	-	-	-	-
				<b>OVERALL DIMENSIONS</b>			<b>SEAT DIMENSIONS</b>			<b>BACK DIMENSIONS</b>					
<b>W</b>	<b>D</b>	<b>H</b>	<b>W</b>	<b>D</b>	<b>H</b>	<b>W</b>	<b>H</b>								
			23	23	42	17	16	28	17	15					
			<b>RTA 00</b>												
 <p><b>6563CS</b>      <b>6563CSMB</b> (Mesh Back)</p> <p><b>Counter Stool w/Arms</b> COM Yardage: N/A Freight Class: 300 Product Weight (lbs.): 21 Cubic Feet Per Carton: 14.5 (1 per carton)</p>	<p>Polypropylene Seat. Stacks 5 high on floor.</p>	<b>6563CS</b>	411	-	-	-	-	-	-	-	-	-	-		
			<b>6563CSMB</b> Mesh Back	473	-	-	-	-	-	-	-	-	-	-	
				<b>OVERALL DIMENSIONS</b>			<b>SEAT DIMENSIONS</b>			<b>BACK DIMENSIONS</b>					
<b>W</b>	<b>D</b>	<b>H</b>	<b>W</b>	<b>D</b>	<b>H</b>	<b>W</b>	<b>H</b>								
			22.5	23	38	17	16	24	17	15					
			<b>RTA 00</b>												
 <p><b>6564</b>      <b>6564MB</b> (Mesh Back)</p> <p><b>Bar Stool w/Arms</b> COM Yardage: 0.75 Freight Class: 300 Product Weight (lbs.): 19 Cubic Feet Per Carton: 14.75 (1 per carton)</p>	<p>Upholstered Seat. Stacks 5 high on floor.</p>	<b>6564</b>	439	461	476	500	532	544	575	631	658	707	779	868	
			<b>6564MB</b> Mesh Back	509	531	548	572	606	617	648	705	732	785	858	946
				<b>OVERALL DIMENSIONS</b>			<b>SEAT DIMENSIONS</b>			<b>BACK DIMENSIONS</b>					
<b>W</b>	<b>D</b>	<b>H</b>	<b>W</b>	<b>D</b>	<b>H</b>	<b>W</b>	<b>H</b>								
			23	23	42.5	17	16	28.5	17	15					
			<b>RTA 00</b>												
 <p><b>6564CS</b>      <b>6564CSMB</b> (Mesh Back)</p> <p><b>Counter Stool w/Arms</b> COM Yardage: 0.75 Freight Class: 300 Product Weight (lbs.): 25 Cubic Feet Per Carton: 14.75 (1 per carton)</p>	<p>Upholstered Seat. Stacks 5 high on floor.</p>	<b>6564CS</b>	439	461	476	500	532	544	575	631	658	707	779	868	
			<b>6564CSMB</b> Mesh Back	509	531	548	572	606	617	648	705	732	785	858	946
				<b>OVERALL DIMENSIONS</b>			<b>SEAT DIMENSIONS</b>			<b>BACK DIMENSIONS</b>					
<b>W</b>	<b>D</b>	<b>H</b>	<b>W</b>	<b>D</b>	<b>H</b>	<b>W</b>	<b>H</b>								
			22.5	23	38	17	16	24.5	17	15					
			<b>RTA 00</b>												









DESCRIPTION	FEATURES	MODEL#	STANDARD TEXTILE GRADES											
			1	2	3	4	5	6	7	8	9	10	11	12
 <b>Bar Stool w/Arms</b> COM Yardage: 0.75 Freight Class: 300 Product Weight (lbs.): 19 Cubic Feet Per Carton: 14.75 (1 per carton)	Upholstered seat and back. Stacks 5 high on floor.	6565	468	490	505	530	562	575	605	662	689	740	810	899
			OVERALL DIMENSIONS			SEAT DIMENSIONS			BACK DIMENSIONS					
			W	D	H	W	D	H	W	H				
			23	23	42.5	17	16	28.5			17	15		
			<b>RTA 00</b>											

DESCRIPTION	FEATURES	MODEL#	STANDARD TEXTILE GRADES											
			1	2	3	4	5	6	7	8	9	10	11	12
 <b>Counter Stool w/Arms</b> COM Yardage: 0.75 Freight Class: 300 Product Weight (lbs.): 27 Cubic Feet Per Carton: 14.75 (1 per carton)	Upholstered Seat. Stacks 5 high on floor.	6565CS	468	490	505	530	562	575	605	662	689	740	810	899
			OVERALL DIMENSIONS			SEAT DIMENSIONS			BACK DIMENSIONS					
			W	D	H	W	D	H	W	H				
			22.5	23	38	17	16	24.5			17	15		
			<b>RTA 00</b>											









DESCRIPTION	FEATURES	MODEL#	STANDARD TEXTILE GRADES															
			1	2	3	4	5	6	7	8	9	10	11	12				
  <b>LB Task w/Arms</b> COM Yardage: N/A Freight Class: 250 Product Weight (lbs.): 23 Cubic Feet Per Carton: 6.50	Polypropylene seat. Ergonomic features: C  <b>Available with tablet:                      Specify (L) left or (R) right tablet.                      (Example: 6577L or 6567TR).</b>	ADJUSTMENTS (2) Pneumatic seat height	6567	6567T	6567MB	6567MBT	List price											
							422	702	473	739								
							OVERALL DIMENSIONS			SEAT DIMENSIONS			BACK DIMENSIONS					
W	D	H	W	D	H	W	H											
			23	20.5	32.5	17	16	15.5-20.5			17	15						
			<b>RTA 1</b>  1 per carton															

DESCRIPTION	FEATURES	MODEL#	STANDARD TEXTILE GRADES															
			1	2	3	4	5	6	7	8	9	10	11	12				
  <b>LB Task w/Arms</b> COM Yardage: N/A Freight Class: 250 Product Weight (lbs.): 24 Cubic Feet Per Carton: 6.50	Upholstered seat. Ergonomic features: C  <b>Available with tablet:                      Specify (L) left or (R) right tablet.                      (Example: 6568TL or 6568TR).</b>	ADJUSTMENTS (2) Pneumatic seat height	6568	6568T	6568MB	6568MBT	List price											
							453	472	488	513	546	557	588	644	669	723	792	881
							OVERALL DIMENSIONS			SEAT DIMENSIONS			BACK DIMENSIONS					
W	D	H	W	D	H	W	H											
			23	20.5	32.5	17	16	16-21			17	14.5						
			<b>RTA 1</b>  1 per carton															

DESCRIPTION	FEATURES	MODEL#	STANDARD TEXTILE GRADES													
			1	2	3	4	5	6	7	8	9	10	11	12		
 <b>LB Task w/Arms</b> COM Yardage: N/A Freight Class: 250 Product Weight (lbs.): 25 Cubic Feet Per Carton: 6.50	Upholstered seat & back. Ergonomic features: C  <b>Available with tablet:                      Specify (L) left or (R) right tablet.                      (Example: 6569TL or 6569TR).</b>	ADJUSTMENTS (2) Pneumatic seat height	6569	6569T	List price											
					483	502	518	542	576	588	617	675	700	752	821	912
					OVERALL DIMENSIONS			SEAT DIMENSIONS			BACK DIMENSIONS					
W	D	H	W	D	H	W	H									
			23	20.5	33	17	15.5	16-21			17	15				
			<b>RTA 1</b>  1 per carton													



DESCRIPTION	FEATURES	MODEL#	STANDARD TEXTILE GRADES											
			1	2	3	4	5	6	7	8	9	10	11	12
 <b>6573</b>	 <b>6573MB (Mesh Back)</b>	6573	340	-	-	-	-	-	-	-	-	-	-	-
		6573MB Mesh Back	385	-	-	-	-	-	-	-	-	-	-	-
<b>OVERALL DIMENSIONS</b>			<b>SEAT DIMENSIONS</b>			<b>BACK DIMENSIONS</b>								
<b>W D H</b>			<b>W D H</b>			<b>W H</b>								
Armchair w/Casters COM Yardage: N/A Freight Class: 250 Product Weight (lbs.): 14 Cubic Feet Per Carton: 13.5 (2 per carton)			Polypropylene Seat. Does not stack.			23 21 32			17 16 17.5			17 14.5		
			<b>RTA 00</b>											
 <b>6573TR</b>	 <b>6573TRMB (Mesh Back)</b>	6573T	578	-	-	-	-	-	-	-	-	-	-	-
		6573TMB Mesh Back	618	-	-	-	-	-	-	-	-	-	-	-
<b>OVERALL DIMENSIONS</b>			<b>SEAT DIMENSIONS</b>			<b>BACK DIMENSIONS</b>								
<b>W D H</b>			<b>W D H</b>			<b>W H</b>								
Armchair w/Tablet and Casters COM Yardage: N/A Freight Class: 300 Product Weight (lbs.): 27 Cubic Feet Per Carton: 14.25 (1 per carton)			Polypropylene Seat. Does not stack. <b>Must specify (L) Left or (R) Right Tablet (Example: 6573TL or 6573TR)</b>			25 26.5 32.5			17 16 18			17 15		
			<b>RTA 00</b>											
 <b>6574</b>	 <b>6574MB (Mesh Back)</b>	6574	373	393	409	434	466	478	509	563	590	643	714	803
		6574MB Mesh Back	418	439	455	479	514	526	556	612	641	694	767	855
<b>OVERALL DIMENSIONS</b>			<b>SEAT DIMENSIONS</b>			<b>BACK DIMENSIONS</b>								
<b>W D H</b>			<b>W D H</b>			<b>W H</b>								
Armchair w/Casters COM Yardage: 0.75 Freight Class: 300 Product Weight (lbs.): 15 Cubic Feet Per Carton: 13.5 (1 per carton)			Upholstered Seat. Does not stack.			23 21.5 33			17 16 18			17 14		
			<b>RTA 00</b>											
 <b>6574TR</b>	 <b>6574TRMB (Mesh Back)</b>	6574T	608	630	647	673	709	723	755	816	846	903	979	1076
		6574TMB Mesh Back	652	675	692	718	754	768	800	862	890	948	1024	1120
<b>OVERALL DIMENSIONS</b>			<b>SEAT DIMENSIONS</b>			<b>BACK DIMENSIONS</b>								
<b>W D H</b>			<b>W D H</b>			<b>W H</b>								
Armchair w/Tablet and Casters COM Yardage: 0.75 Freight Class: 300 Product Weight (lbs.): 29 Cubic Feet Per Carton: 14.25 (1 per carton)			Upholstered Seat. Does not stack. <b>Must specify (L) Left or (R) Right Tablet (Example: 6574TL or 6574TR)</b>			25 26.5 32.5			17 16 18			17 15		
			<b>RTA 00</b>											
 <b>6575</b>		6575	389	409	426	450	483	494	525	579	606	659	728	817
<b>OVERALL DIMENSIONS</b>			<b>SEAT DIMENSIONS</b>			<b>BACK DIMENSIONS</b>								
<b>W D H</b>			<b>W D H</b>			<b>W H</b>								
Armchair w/Casters COM Yardage: 0.75 Freight Class: 250 Product Weight (lbs.): 15 Cubic Feet Per Carton: 13.5 (2 per carton)			Upholstered Seat and Back. Does not stack.			23 21.5 32.5			17 15.5 18			17 14.5		
			<b>RTA 00</b>											





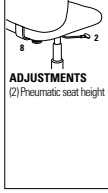

DESCRIPTION	FEATURES	MODEL#	STANDARD TEXTILE GRADES																																
			1	2	3	4	5	6	7	8	9	10	11	12																					
 <b>6575TR</b> <b>Armchair w/Tablet and Casters</b> COM Yardage: 0.75 Freight Class: 300 Product Weight (lbs.): 30 Cubic Feet Per Carton: 14.25 (1 per carton)	Upholstered Seat & Back. Does not stack. <b>Must specify (L) Left or (R) Right Tablet (Example: 6575TL or 6575TR)</b>		633	655	672	699	735	748	780	842	871	927	1005	1101																					
		<table border="1"> <thead> <tr> <th colspan="3">OVERALL DIMENSIONS</th> <th colspan="3">SEAT DIMENSIONS</th> <th colspan="2">BACK DIMENSIONS</th> </tr> <tr> <th>W</th> <th>D</th> <th>H</th> <th>W</th> <th>D</th> <th>H</th> <th>W</th> <th>H</th> </tr> </thead> <tbody> <tr> <td>25</td> <td>26.5</td> <td>32.5</td> <td>17</td> <td>16</td> <td>18.5</td> <td>17</td> <td>15</td> </tr> </tbody> </table>	OVERALL DIMENSIONS			SEAT DIMENSIONS			BACK DIMENSIONS		W	D	H	W	D	H	W	H	25	26.5	32.5	17	16	18.5	17	15									
OVERALL DIMENSIONS			SEAT DIMENSIONS			BACK DIMENSIONS																													
W	D	H	W	D	H	W	H																												
25	26.5	32.5	17	16	18.5	17	15																												
 <b>6577</b> <b>Armless Chair w/Casters</b> COM Yardage: N/A Freight Class: 300 Product Weight (lbs.): 12 Cubic Feet Per Carton: 13.5 (2 per carton)	Polypropylene Seat. Does not stack.		295	-	-	-	-	-	-	-	-	-	-	-																					
		<table border="1"> <thead> <tr> <th colspan="3">OVERALL DIMENSIONS</th> <th colspan="3">SEAT DIMENSIONS</th> <th colspan="2">BACK DIMENSIONS</th> </tr> <tr> <th>W</th> <th>D</th> <th>H</th> <th>W</th> <th>D</th> <th>H</th> <th>W</th> <th>H</th> </tr> </thead> <tbody> <tr> <td>21</td> <td>21</td> <td>33</td> <td>17</td> <td>16</td> <td>17.5</td> <td>17</td> <td>14.5</td> </tr> </tbody> </table>	OVERALL DIMENSIONS			SEAT DIMENSIONS			BACK DIMENSIONS		W	D	H	W	D	H	W	H	21	21	33	17	16	17.5	17	14.5									
OVERALL DIMENSIONS			SEAT DIMENSIONS			BACK DIMENSIONS																													
W	D	H	W	D	H	W	H																												
21	21	33	17	16	17.5	17	14.5																												
 <b>6577MB (Mesh Back)</b>			337	-	-	-	-	-	-	-	-	-	-	-																					
	<table border="1"> <thead> <tr> <th colspan="3">OVERALL DIMENSIONS</th> <th colspan="3">SEAT DIMENSIONS</th> <th colspan="2">BACK DIMENSIONS</th> </tr> <tr> <th>W</th> <th>D</th> <th>H</th> <th>W</th> <th>D</th> <th>H</th> <th>W</th> <th>H</th> </tr> </thead> <tbody> <tr> <td>24.75</td> <td>26.5</td> <td>32.5</td> <td>17</td> <td>16</td> <td>18</td> <td>17</td> <td>15</td> </tr> </tbody> </table>	OVERALL DIMENSIONS			SEAT DIMENSIONS			BACK DIMENSIONS		W	D	H	W	D	H	W	H	24.75	26.5	32.5	17	16	18	17	15										
OVERALL DIMENSIONS			SEAT DIMENSIONS			BACK DIMENSIONS																													
W	D	H	W	D	H	W	H																												
24.75	26.5	32.5	17	16	18	17	15																												
 <b>6577TR</b> <b>Armless Chair w/Tablet and Casters</b> COM Yardage: N/A Freight Class: 300 Product Weight (lbs.): 27 Cubic Feet Per Carton: 14.25 (1 per carton)	Polypropylene Seat. Does not stack. <b>Must specify (L) Left or (R) Right Tablet (Example: 6577TL or 6577TR)</b>		526	-	-	-	-	-	-	-	-	-	-	-																					
		<table border="1"> <thead> <tr> <th colspan="3">OVERALL DIMENSIONS</th> <th colspan="3">SEAT DIMENSIONS</th> <th colspan="2">BACK DIMENSIONS</th> </tr> <tr> <th>W</th> <th>D</th> <th>H</th> <th>W</th> <th>D</th> <th>H</th> <th>W</th> <th>H</th> </tr> </thead> <tbody> <tr> <td>21</td> <td>21.5</td> <td>33</td> <td>17</td> <td>16</td> <td>18</td> <td>17</td> <td>14</td> </tr> </tbody> </table>	OVERALL DIMENSIONS			SEAT DIMENSIONS			BACK DIMENSIONS		W	D	H	W	D	H	W	H	21	21.5	33	17	16	18	17	14									
OVERALL DIMENSIONS			SEAT DIMENSIONS			BACK DIMENSIONS																													
W	D	H	W	D	H	W	H																												
21	21.5	33	17	16	18	17	14																												
 <b>6577TRMB (Mesh Back)</b>			567	-	-	-	-	-	-	-	-	-	-	-																					
	<table border="1"> <thead> <tr> <th colspan="3">OVERALL DIMENSIONS</th> <th colspan="3">SEAT DIMENSIONS</th> <th colspan="2">BACK DIMENSIONS</th> </tr> <tr> <th>W</th> <th>D</th> <th>H</th> <th>W</th> <th>D</th> <th>H</th> <th>W</th> <th>H</th> </tr> </thead> <tbody> <tr> <td>24.75</td> <td>26.5</td> <td>32.5</td> <td>17</td> <td>16</td> <td>18</td> <td>17</td> <td>15</td> </tr> </tbody> </table>	OVERALL DIMENSIONS			SEAT DIMENSIONS			BACK DIMENSIONS		W	D	H	W	D	H	W	H	24.75	26.5	32.5	17	16	18	17	15										
OVERALL DIMENSIONS			SEAT DIMENSIONS			BACK DIMENSIONS																													
W	D	H	W	D	H	W	H																												
24.75	26.5	32.5	17	16	18	17	15																												
 <b>6578</b> <b>Armless Chair w/Casters</b> COM Yardage: 0.75 Freight Class: 300 Product Weight (lbs.): 13 Cubic Feet Per Carton: 13.5 (2 per carton)	Upholstered Seat. Stacks 10 high on dolly.		326	348	362	388	421	433	463	518	544	598	667	755																					
		<table border="1"> <thead> <tr> <th colspan="3">OVERALL DIMENSIONS</th> <th colspan="3">SEAT DIMENSIONS</th> <th colspan="2">BACK DIMENSIONS</th> </tr> <tr> <th>W</th> <th>D</th> <th>H</th> <th>W</th> <th>D</th> <th>H</th> <th>W</th> <th>H</th> </tr> </thead> <tbody> <tr> <td>21</td> <td>21.5</td> <td>33</td> <td>17</td> <td>16</td> <td>18</td> <td>17</td> <td>14</td> </tr> </tbody> </table>	OVERALL DIMENSIONS			SEAT DIMENSIONS			BACK DIMENSIONS		W	D	H	W	D	H	W	H	21	21.5	33	17	16	18	17	14									
OVERALL DIMENSIONS			SEAT DIMENSIONS			BACK DIMENSIONS																													
W	D	H	W	D	H	W	H																												
21	21.5	33	17	16	18	17	14																												
 <b>6578MB (Mesh Back)</b>			374	391	408	431	466	478	507	566	593	645	718	808																					
	<table border="1"> <thead> <tr> <th colspan="3">OVERALL DIMENSIONS</th> <th colspan="3">SEAT DIMENSIONS</th> <th colspan="2">BACK DIMENSIONS</th> </tr> <tr> <th>W</th> <th>D</th> <th>H</th> <th>W</th> <th>D</th> <th>H</th> <th>W</th> <th>H</th> </tr> </thead> <tbody> <tr> <td>24.75</td> <td>26.5</td> <td>32.5</td> <td>17</td> <td>16</td> <td>18.5</td> <td>17</td> <td>15</td> </tr> </tbody> </table>	OVERALL DIMENSIONS			SEAT DIMENSIONS			BACK DIMENSIONS		W	D	H	W	D	H	W	H	24.75	26.5	32.5	17	16	18.5	17	15										
OVERALL DIMENSIONS			SEAT DIMENSIONS			BACK DIMENSIONS																													
W	D	H	W	D	H	W	H																												
24.75	26.5	32.5	17	16	18.5	17	15																												
 <b>6578TR</b> <b>Armless Chair w/Tablet and Casters</b> COM Yardage: 0.75 Freight Class: 300 Product Weight (lbs.): 28 Cubic Feet Per Carton: 14.25 (1 per carton)	Upholstered Seat. Does not stack. <b>Must specify (L) Left or (R) Right Tablet (Example: 6578TL or 6578TR)</b>		558	579	597	624	660	672	705	767	796	852	929	1025																					
		<table border="1"> <thead> <tr> <th colspan="3">OVERALL DIMENSIONS</th> <th colspan="3">SEAT DIMENSIONS</th> <th colspan="2">BACK DIMENSIONS</th> </tr> <tr> <th>W</th> <th>D</th> <th>H</th> <th>W</th> <th>D</th> <th>H</th> <th>W</th> <th>H</th> </tr> </thead> <tbody> <tr> <td>24.75</td> <td>26.5</td> <td>32.5</td> <td>17</td> <td>16</td> <td>18.5</td> <td>17</td> <td>15</td> </tr> </tbody> </table>	OVERALL DIMENSIONS			SEAT DIMENSIONS			BACK DIMENSIONS		W	D	H	W	D	H	W	H	24.75	26.5	32.5	17	16	18.5	17	15									
OVERALL DIMENSIONS			SEAT DIMENSIONS			BACK DIMENSIONS																													
W	D	H	W	D	H	W	H																												
24.75	26.5	32.5	17	16	18.5	17	15																												
 <b>6578TRMB (Mesh Back)</b>			596	617	635	662	698	710	743	805	834	890	968	1063																					
	<table border="1"> <thead> <tr> <th colspan="3">OVERALL DIMENSIONS</th> <th colspan="3">SEAT DIMENSIONS</th> <th colspan="2">BACK DIMENSIONS</th> </tr> <tr> <th>W</th> <th>D</th> <th>H</th> <th>W</th> <th>D</th> <th>H</th> <th>W</th> <th>H</th> </tr> </thead> <tbody> <tr> <td>24.75</td> <td>26.5</td> <td>32.5</td> <td>17</td> <td>16</td> <td>18.5</td> <td>17</td> <td>15</td> </tr> </tbody> </table>	OVERALL DIMENSIONS			SEAT DIMENSIONS			BACK DIMENSIONS		W	D	H	W	D	H	W	H	24.75	26.5	32.5	17	16	18.5	17	15										
OVERALL DIMENSIONS			SEAT DIMENSIONS			BACK DIMENSIONS																													
W	D	H	W	D	H	W	H																												
24.75	26.5	32.5	17	16	18.5	17	15																												

DESCRIPTION	FEATURES	MODEL#	STANDARD TEXTILE GRADES															
			1	2	3	4	5	6	7	8	9	10	11	12				
 <p><b>Armless chair w/Casters</b> COM Yardage: 0.75 Freight Class: 250 Product Weight (lbs.): 13 Cubic Feet Per Carton: 13.5 (2 per carton)</p>	Upholstered Seat and Back. Does not stack.	6579	358	377	393	417	452	463	492	549	575	628	698	786				
			OVERALL DIMENSIONS			SEAT DIMENSIONS			BACK DIMENSIONS									
			W	D	H	W	D	H	W	H								
			21	21.5	32.5	17	15.5	18	17	14.5								
			<b>RTA 00</b>															

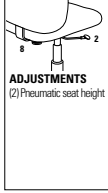
DESCRIPTION	FEATURES	MODEL#	STANDARD TEXTILE GRADES															
			1	2	3	4	5	6	7	8	9	10	11	12				
 <p><b>Armless Chair w/Tablet and Casters</b> COM Yardage: 0.75 Freight Class: 300 Product Weight (lbs.): 18 Cubic Feet Per Carton: 11.75 (1 per carton)</p>	Upholstered Seat & Back. Does not stack. <b>Must specify (L) Left or (R) Right Tablet (Example: 6579TL or 6579TR)</b>	6579T	596	617	635	662	698	710	743	805	834	890	968	1063				
			OVERALL DIMENSIONS			SEAT DIMENSIONS			BACK DIMENSIONS									
			W	D	H	W	D	H	W	H								
			23.5	21.5	33	17	16	18.5	17	15								
			<b>RTA 00</b>															

DESCRIPTION	FEATURES	MODEL#	STANDARD TEXTILE GRADES															
			1	2	3	4	5	6	7	8	9	10	11	12				
 <p><b>LB Task Drafting Chair</b> COM Yardage: 0.75 Freight Class: 250 Product Weight (lbs.): 28 Cubic Feet Per Carton: 8.25 (1 per carton)</p>	 <p><b>ADJUSTMENTS</b> (2) Pneumatic seat height</p>	6586	662	681	699	723	755	770	799	855	883	936	1008	1098				
			OVERALL DIMENSIONS			SEAT DIMENSIONS			BACK DIMENSIONS									
			W	D	H	W	D	H	W	H								
			24	21.5	21.5	17	16	22-32	17	14.5								
			<b>RTA 1</b> 															

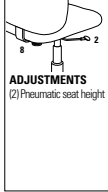
DESCRIPTION	FEATURES	MODEL#	STANDARD TEXTILE GRADES															
			1	2	3	4	5	6	7	8	9	10	11	12				
 <p><b>LB Task Drafting Chair</b> COM Yardage: N/A Freight Class: 250 Product Weight (lbs.): 26 Cubic Feet Per Carton: 8.25 (1 per carton)</p>	 <p><b>ADJUSTMENTS</b> (2) Pneumatic seat height</p>	6587	556	-	-	-	-	-	-	-	-	-	-	-				
			OVERALL DIMENSIONS			SEAT DIMENSIONS			BACK DIMENSIONS									
			W	D	H	W	D	H	W	H								
			24.0	21.5	42.5	17	16	22-32	17	14.5								
			<b>RTA 1</b> 															

DESCRIPTION	FEATURES	MODEL#	STANDARD TEXTILE GRADES															
			1	2	3	4	5	6	7	8	9	10	11	12				
 <p><b>LB Task Drafting Chair</b> COM Yardage: 0.75 Freight Class: 250 Product Weight (lbs.): 28 Cubic Feet Per Carton: 8.25 (1 per carton)</p>	 <p><b>ADJUSTMENTS</b> (2) Pneumatic seat height</p>	6588	627	647	663	685	723	733	764	819	848	901	974	1062				
				6588MB	613	633	650	675	708	720	751	809	835	887	960	1051		
					OVERALL DIMENSIONS			SEAT DIMENSIONS			BACK DIMENSIONS							
			W	D	H	W	D	H	W	H								
			24	21.5	42.5	17	16	22-32	17	14.5								
			<b>RTA 1</b> 															

SPRITZ™



Spritz Multi-Purpose chairs are offered in a Task, Nesting w/Flip up seat and Drafting Stool configuration.

NESTING FEATURES



Articulating back on nesting chairs and drafting stools.



Flip up seat on nesting chairs.

MECHANISMS OPTIONS

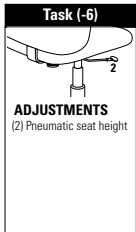

**Ergonomic Features:**  
C, G, M, N, U

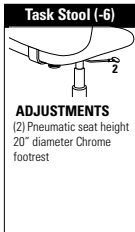

**Ergonomic Features:**  
C, G, M, N, U

SPRITZ WORK & TASK CHAIRS



For Spritz Task chairs, please refer to Work + Task section of pricebook.

STANDARD FEATURES

- An exceptionally comfortable chair series featuring a sophisticated, translucent mesh and models for all applications.
- Features an auto-adjusting comfort back.
- Spring loaded back reacts to body pressure and articulates 12°.
- Multi-purpose models standard with Global's high quality Soft Descent™ pneumatic lift which slowly and gently lowers the seat height of the chair making it easy to obtain the exact seat height you desire.
- Five prong, injection molded, fiberglass reinforced nylon Black base with C10 dual wheel carpet casters.
- Nesting chairs have a flip up seat allowing chairs to stack horizontally.
- When nesting horizontal nesting chairs, each additional chair adds 10" to depth.
- Nesting chairs are standard with four Black nylon glides, C1 carpet casters or with two casters at front, two glides at rear.
- Chairs are "Wall Safe". Rear legs hit the baseboard first leaving clearance between the back of the chair and the wall, saving both the chair and the wall from damage.
- Seat upholstery options: fabric, vinyl or leather.
- Models can be ordered in Leather using appropriate grade. No leather/mock leather combination available.

OPTIONAL FEATURES

- For additional caster options, please refer to the Arm and Caster section.
- Optional casters may be priced higher than the standard casters for your chair and the difference will be charged. Lower priced optional casters will not be credited.

OPTION CODES

Please add option codes in the following order:

- **Model number**  
6762-6 Task Chair w/Arms  
6763-6 Task Chair without Arms  
6764 Nesting Chair on Glides  
6765 Nesting Chair w/arms on Glides  
6767-6 Drafting Stool without Arms  
6768-6 Drafting Stool w/Arms
- Add (-C) to model number if ordering with casters.  
Add (-FC) to model number if ordering Front casters/rear glides.
- **Fabric**  
Specify fabric code for seat.
- **Frame**  
(BK) Black frame finish ..... **Standard**  
(TU) Tungsten frame finish ..... **Standard**  
(CHR) Chrome frame finish ..... **Add \$45**
- **Base** (task models/drafting stools only)  
(B-BK) Black nylon base..... **Standard**  
(B-M2) Chrome Spider base ..... **Add \$45**
- **Casters** (task models /drafting stools only)  
(C10) Dual wheel carpet casters ..... **Standard**  
(C10R) Dual wheel hard floor casters..... **Add \$46**
- **Casters** (nesting models only)  
(C1) Dual wheel carpet casters ..... **Standard**  
(C9R) Dual wheel hard floor casters..... **Add \$51**
- **Mesh Back**  
(U1) Black  
(U2) Burgundy  
(U3) Blue  
(U4) Green  
(colors shown on website)
- **Chair Assembly**  
(task models /drafting stools only)  
(-SU) Assembled in Box..... **Add \$55**

EXAMPLE OF ORDER CODE: (Task models/Drafting Stool Models)

6762-6	WA50	TU	B-BK	C10	U2	SU
Model Number	Fabric	Frame	Base	Casters	Mesh	Chair Assembly

EXAMPLE OF ORDER CODE: (Nesting Models)

6764C	WA50	TU	C9R	U2
Model Number	Fabric	Frame	Casters	Mesh

DESCRIPTION	FEATURES	MODEL#	STANDARD TEXTILE GRADES											
			1	2	3	4	5	6	7	8	9	10	11	12
		6762-6	577	599	614	639	673	689	719	769	806	848	935	1027
			OVERALL DIMENSIONS			SEAT DIMENSIONS			BACK DIMENSIONS					
			W	D	H	W	D	H	W	H				
			23.5	20.5	31	18	16.5	15.5	17	16.5				

**Task Chair w/Arms**  
COM Yardage: 0.75  
Freight Class: 250  
Product Weight (lbs.): 29  
Cubic Feet Per Carton: 9.75

RTA 00

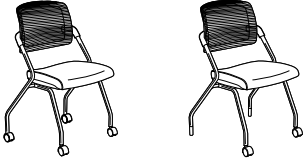

DESCRIPTION	FEATURES	MODEL#	STANDARD TEXTILE GRADES											
			1	2	3	4	5	6	7	8	9	10	11	12
 <p><b>Task Chair without Arms</b> COM Yardage: 0.75 Freight Class: 250 Product Weight (lbs.): 28 Cubic Feet Per Carton: 9.75</p>		<b>6763-6</b>	552	572	588	612	646	662	693	742	780	822	909	1002
			<b>OVERALL DIMENSIONS</b>			<b>SEAT DIMENSIONS</b>			<b>BACK DIMENSIONS</b>					
			<b>W</b>	<b>D</b>	<b>H</b>	<b>W</b>	<b>D</b>	<b>H</b>	<b>W</b>	<b>H</b>				
			20.5	20.5	31	18	16.5	15.5	17	16.5				
		<b>RTA 00</b>												

DESCRIPTION	FEATURES	MODEL#	STANDARD TEXTILE GRADES											
			1	2	3	4	5	6	7	8	9	10	11	12
 <p><b>Armless Flip Seat Nesting Chair w/Glides</b> COM Yardage: 0.75 Freight Class: 300 Product Weight (lbs.): 22 Cubic Feet Per Carton: 11.25</p>		<b>6764</b>	479	500	515	539	573	590	621	669	707	749	835	927
			<b>OVERALL DIMENSIONS</b>			<b>SEAT DIMENSIONS</b>			<b>BACK DIMENSIONS</b>					
			<b>W</b>	<b>D</b>	<b>H</b>	<b>W</b>	<b>D</b>	<b>H</b>	<b>W</b>	<b>H</b>				
			20.5	23	33	18	17	17	17	16				
	Seat Flips up for nesting Ergonomic Features: G, M, N	<b>RTA 00</b>												

DESCRIPTION	FEATURES	MODEL#	STANDARD TEXTILE GRADES												
			1	2	3	4	5	6	7	8	9	10	11	12	
 <p><b>Armless Flip Seat Nesting Chair w/Casters</b> COM Yardage: 0.75 Freight Class: 300 Product Weight (lbs.): 22 Cubic Feet Per Carton: 11.25</p>		<b>6764C</b>	479	500	515	539	573	590	621	669	707	749	835	927	
			<b>6764FC</b>	479	500	515	539	573	590	621	669	707	749	835	927
			<b>OVERALL DIMENSIONS</b>			<b>SEAT DIMENSIONS</b>			<b>BACK DIMENSIONS</b>						
		<b>W</b>	<b>D</b>	<b>H</b>	<b>W</b>	<b>D</b>	<b>H</b>	<b>W</b>	<b>H</b>						
	C= Casters all 4 legs FC=Casters on front legs only Seat Flips up for nesting Ergonomic Features: G, M, N		20.5	23	33	18	17	17	17	16					
		<b>RTA 00</b>													

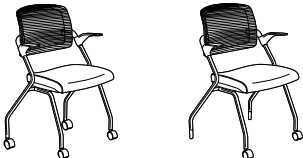
DESCRIPTION	FEATURES	MODEL#	STANDARD TEXTILE GRADES											
			1	2	3	4	5	6	7	8	9	10	11	12
 <p><b>Flip Seat Nesting Chair w/Arms &amp; Glides</b> COM Yardage: 0.75 Freight Class: 150 Product Weight (lbs.): 23 Cubic Feet Per Carton: 11.75</p>		<b>6765</b>	510	531	546	571	605	622	652	701	739	781	869	961
			<b>OVERALL DIMENSIONS</b>			<b>SEAT DIMENSIONS</b>			<b>BACK DIMENSIONS</b>					
			<b>W</b>	<b>D</b>	<b>H</b>	<b>W</b>	<b>D</b>	<b>H</b>	<b>W</b>	<b>H</b>				
			23.75	23	33	18.5	17	17	17	16				
	Seat Flips up for nesting Ergonomic Features: G, M, N	<b>RTA 00</b>												

DESCRIPTION	FEATURES	MODEL#	STANDARD TEXTILE GRADES												
			1	2	3	4	5	6	7	8	9	10	11	12	
 <p><b>Flip Seat Nesting Chair w/Arms &amp; Casters</b> COM Yardage: 0.75 Freight Class: 300 Product Weight (lbs.): 23 Cubic Feet Per Carton: 11.75</p>		<b>6765C</b>	510	531	546	571	605	622	652	701	739	781	869	961	
			<b>6765FC</b>	510	531	546	571	605	622	652	701	739	781	869	961
			<b>OVERALL DIMENSIONS</b>			<b>SEAT DIMENSIONS</b>			<b>BACK DIMENSIONS</b>						
		<b>W</b>	<b>D</b>	<b>H</b>	<b>W</b>	<b>D</b>	<b>H</b>	<b>W</b>	<b>H</b>						
	C= Casters all 4 legs FC=Casters on front legs only Seat Flips up for nesting Ergonomic Features: G, M, N		23.75	23	33	18.5	17	17	17	16					
		<b>RTA 00</b>													

DESCRIPTION	FEATURES	MODEL#	STANDARD TEXTILE GRADES											
			1	2	3	4	5	6	7	8	9	10	11	12
 <p><b>Armless Drafting Stool</b>                      COM Yardage: 0.75                      Freight Class: 250                      Product Weight (lbs.): 28                      Cubic Feet Per Carton: 9.75</p>		<b>6767-6</b>	634	654	669	692	724	739	769	815	851	891	974	1061
			<b>OVERALL DIMENSIONS</b>			<b>SEAT DIMENSIONS</b>			<b>BACK DIMENSIONS</b>					
			<b>W</b>	<b>D</b>	<b>H</b>	<b>W</b>	<b>D</b>	<b>H</b>	<b>W</b>	<b>H</b>				
			20.5	20.5	42.5	18	16.5	22	17	16.5				
			<b>RTA 00</b>											
 <p><b>Drafting Stool w/Arms</b>                      COM Yardage: 0.75                      Freight Class: 250                      Product Weight (lbs.): 31                      Cubic Feet Per Carton: 9.75</p>		<b>6768-6</b>	660	680	696	718	750	766	795	842	878	918	1001	1088
			<b>OVERALL DIMENSIONS</b>			<b>SEAT DIMENSIONS</b>			<b>BACK DIMENSIONS</b>					
			<b>W</b>	<b>D</b>	<b>H</b>	<b>W</b>	<b>D</b>	<b>H</b>	<b>W</b>	<b>H</b>				
			23.5	20.5	42.5	18	16.5	22	17	16.5				
			<b>RTA 00</b>											

SPYKER™



Armless Chair  
model 6791



Armchair  
model 6790

	Chair Stacking Capability	
	Stacks on floor	Stacks on dolly
<b>Armless</b>		
6791	up to 10 high	up to 12 high (use 6783)
<b>With Arms</b>		
6790	up to 7 high	up to 7 high (use 6783)

STANDARD FEATURES

- A comfortable, high quality, lightweight, all polymer stacking chair intended for use indoors or outdoors.
- Perforations in the chair's seat and back provide ventilation and wet weather drainage.
- Weather resistant, UV resistant and stain resistant with a modern design.
- Chair legs are equipped with translucent non-marking glides as standard. Suitable for outdoor environments, carpet and hard surface flooring.
- Chairs are stocked in 2 plastic finishes:  
Alloy (ALY)  
Char (CHA)
- No upholstery options available.
- Rated to 300 lbs.
- Spyker achieves its strength and durability using glass filler polymer. Evidence of this material may be visible on the surface and is often more evident in darker colors.

OPTIONAL FEATURES

- Also available for special order in the following plastic finishes:\*
- Milk (MLK)\*
- Saffron (SAF)\*
- Sky (SKY)\*
- Turtledove (TUR)\*
- \*Minimum order quantity of 24 chairs of the same model and finish. All orders over 24 must be in quantities of 4. 16 week average lead time applies.
- Custom finishes available with a minimum order quantity of 300 chairs. Please contact CustomerCare for details.

EXAMPLE OF SPYKER ORDER CODE:

6791	ALY
Model Number	Finish

DESCRIPTION FEATURES MODEL# STANDARD TEXTILE GRADES



Arm Chair

COM Yardage: N/A  
Freight Class: 92.5  
Product Weight (lbs.): 9  
Cubic Feet Per Carton: 16.24 (4 per carton)

Stacks 7 high on floor.  
Stacks 7 high on dolly.

6790	1	2	3	4	5	6	7	8	9	10	11	12
	195											

OVERALL DIMENSIONS			SEAT DIMENSIONS			BACK DIMENSIONS	
W	D	H	W	D	H	W	H
23.23	20.86	31.29	17	17.75	17.71	17	15

RTA 00 4 per carton (pricing and specifications are for one chair)

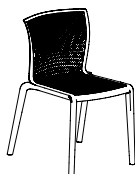

Armless Chair

COM Yardage: N/A  
Freight Class: 92.5  
Product Weight (lbs.): 8.2  
Cubic Feet Per Carton: 14.08 (4 per carton)

Stacks 10 high on floor.  
Stacks 12 high on dolly.

6791	1	2	3	4	5	6	7	8	9	10	11	12
	175											

OVERALL DIMENSIONS			SEAT DIMENSIONS			BACK DIMENSIONS	
W	D	H	W	D	H	W	H
17.91	20.86	31.29	17	17.75	17.71	17	15

RTA 00 4 per carton (pricing and specifications are for one chair)

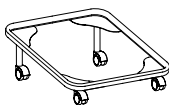

Dolly for Spyker and Bakhita Chairs

COM Yardage: N/A  
Freight Class: 150  
Product Weight (lbs.): 16  
Cubic Feet Per Carton: 2.90

6783	1	2	3	4	5	6	7	8	9	10	11	12
	260											

OVERALL DIMENSIONS			SEAT DIMENSIONS			BACK DIMENSIONS	
W	D	H	W	D	H	W	H
19.75	23.25	9.75					

RTA 00 1 per carton

**STREAM**



**model 2075APP**  
Stacking, 4-Leg Arm Chair



**model 2076NPU**  
Stacking, Sled Base Chair, Armless



**model 2075APPT**  
4-Leg Chair, w/Tablet



**model 2075CSAPP**  
Stacking Bar Stool, w/Arms

**STANDARD FEATURES**

- Stream multi-purpose product family includes: four-leg and sled base chairs and four-leg bar and counter height stools.
- Chairs and stools have polypropylene seats and back with or without arms. Choose from 14 finishes, arm colors match selected seat/back finish.
- Four-leg chairs are standard with Black frame and non-marking nylon bullet glides. Specify bullet-shaped glide color.
- Sled base chair includes black polypropylene glides.
- Upholstered models are equipped with a color matching shroud beneath the seat.
- Tablet models are available on four-leg and sled base chairs and backpack racks are available on four-leg models only.
- Chairs with tablet or backpack racks do not stack. Backpack racks are available on four-leg chairs only.
- Tablets hinge up to allow ease of egress and slide forward and back to comfortably fit most users.
- Standard tablet size is 18"D x 14.5"W and is made of Black polymer (D8). Tablets are specified left (LT) or right (RT) as seated.
- Upholstery options: fabric, vinyl or leather. Not available in leather/mock leather.

**OPTIONAL FEATURES**

- Casters are available on four-legged chairs only. Specify (FC). Add \$84. For carpet casters, please specify (DC). No additional upcharge.
- For hard floor casters specify (RC) and add additional \$16.
- For tablet models, an optional 18.5"D x 18.5"W high pressure laminate writing tablet is available. The core is veneer plywood with a bullnose, clear lacquered edge. Offered in 5 laminate finishes. Add \$45.

Please specify models with option codes in the following order:

- Model number**  
Enter Model number.
- Textile**  
Specify textile code for back (UU models only). Specify textile code for seat (PU, UU models only).
- Seat/back finish** (no upcharge)
 







(BZB) Buzz Blue	(CCT) Cactus
(CRO) Carrot	(IVC) Cloud
(DJN) Dijon	(EGP) Eggplant
(FOG) Fog	(FRO) Frost
(INK) Ink	(LAB) Latte
(BLK) Night	(SND) Sand
(SAR) Scarlet	(SHW) Shadow
- Frame with bullet glides/casters** (four-legged chair models only)
  - (FG) Glides
  - (FC) Casters. Add \$84.
- Bullet glide color** (four-legged chair and stool models only)
 

(BZB) Buzz Blue	(CCT) Cactus
(CRO) Carrot	(IVC) Cloud
(DJN) Dijon	(EGP) Eggplant
(FOG) Fog	(FRO) Frost
(INK) Ink	(LAB) Latte
(BLK) Night	(SND) Sand
(SAR) Scarlet	(SHW) Shadow
- Sled chair glides** (sled chair models only)
  - (GL) Black glides.
  - (NM) Opaque non-marking glides.
- Frame finish**
  - (BK) Black. No upcharge.
  - (TN) Tungsten. No upcharge.
  - (CM) Chrome. Add \$36 (chair height models).
  - (CM) Chrome. Add \$70 (bar/counter stool models).
- Caster type (if applicable)**
  - (DC) C107 carpet.
  - (RC) C107R hard floor. Add \$16.
- Tablet "T" models only**
  - (LT) Left
  - (RT) Right
- Tablet option "T" models only**
  - (D8) Black polymer. Black polymer 18"Dx14.5"W. No upcharge.
  - Laminate finish (18.5Dx18.5"W). Add \$45
  - (D1) Black laminate. Add \$45.
  - (D2) Grey laminate. Add \$45.
  - (D3) Constellation Java laminate. Add \$45.
  - (D4) White laminate. Add \$45.
  - (D5) Tiger Maple laminate. Add \$45.







	Stream Chairs Stacking Capability		Stream Stools Stacking Capability
	Chair Stacking Capability		Stool Stacking Capability
	Stacks on floor	Stacks on dolly 2085	Stacks on floor only
<b>Four-Leg (Glide/Caster) + Sled Base Models</b>			
Polypropylene seat	up to 5 high	up to 15 high	up to 5 high
Poly back & Upholstered seat	up to 5 high	up to 10 high	up to 5 high
Upholstered seat & back	up to 5 high	up to 10 high	up to 5 high







**EXAMPLE STREAM ORDER CODE:**



2075NPP	-	-	-IVC	-FG	-BLK	-CM	-	-	-
Model #	Back textile	Seat textile	Seat/back finish	Glides/Casters	Glide color	Frame finish	Caster type	Tablet	Tablet finish





DESCRIPTION	FEATURES	MODEL#	STANDARD TEXTILE GRADES												
			1	2	3	4	5	6	7	8	9	10	11	12	
 <p><b>Armchair</b> COM Yardage: N/A Freight Class: 250 Product Weight (lbs.): 15.50 Cubic Feet Per Carton: 14</p>	<p>Glides + Casters Stacks 5 high on floor. Stacks 15 high on dolly.</p>	<b>2075APP</b> 364	Polypropylene seat & back												
		<b>OVERALL DIMENSIONS</b>			<b>SEAT DIMENSIONS</b>			<b>BACK DIMENSIONS</b>							
		<b>W</b>	<b>D</b>	<b>H</b>	<b>W</b>	<b>D</b>	<b>H</b>	<b>W</b>	<b>H</b>						
		24	25	33.25	18	18	17	16	16.5						
		<b>RTA 00</b>			4 per carton (pricing and specifications are for one seat unit)										
  <p><b>2075APU</b>      <b>2075AUU</b></p> <p><b>Armchair</b> COM Yardage: .75 Freight Class: 250 Product Weight: 18.50 Cubic Feet Per Carton: 14</p>	<p>Glides + Casters Stacks 5 high on floor. Stacks 10 high on dolly.</p>	<b>2075APU</b> 499	517	532	553	584	598	626	670	704	741	819	902		
		Upholstered seat													
		<b>2075AUU</b> 584	602	617	638	669	584	711	755	789	827	905	989		
		Upholstered seat & back													
		<b>OVERALL DIMENSIONS</b>			<b>SEAT DIMENSIONS</b>			<b>BACK DIMENSIONS</b>							
<b>W</b>	<b>D</b>	<b>H</b>	<b>W</b>	<b>D</b>	<b>H</b>	<b>W</b>	<b>H</b>								
24	25	33.25	17.5	18	17.5	16	16								
<b>RTA 00</b>			4 per carton (pricing and specifications are for one seat unit)												
 <p><b>Armless Chair</b> COM Yardage: N/A Freight Class: 300 Product Weight: 11 Cubic Feet Per Carton: 13</p>	<p>Glides + Casters Stacks 5 high on floor. Stacks 15 high on dolly.</p>	<b>2075NPP</b> 283	Polypropylene seat & back												
		<b>OVERALL DIMENSIONS</b>			<b>SEAT DIMENSIONS</b>			<b>BACK DIMENSIONS</b>							
		<b>W</b>	<b>D</b>	<b>H</b>	<b>W</b>	<b>D</b>	<b>H</b>	<b>W</b>	<b>H</b>						
		20.5	25	33.25	18	18	18	16	16.5						
		<b>RTA 00</b>			4 per carton (pricing and specifications are for one seat unit)										
  <p><b>2075NPU</b>      <b>2075NUU</b></p> <p><b>Armless Chair</b> COM Yardage: .75 Freight Class: 250 Product Weight: 14 Cubic Feet Per Carton: 13</p>	<p>Glides + Casters Stacks 5 high on floor. Stacks 10 high on dolly.</p>	<b>2075NPU</b> 424	442	455	476	505	519	546	588	621	657	732	812		
		Upholstered seat													
		<b>2075NUU</b> 506	525	539	559	589	603	629	672	705	741	816	896		
		Upholstered seat & back													
		<b>OVERALL DIMENSIONS</b>			<b>SEAT DIMENSIONS</b>			<b>BACK DIMENSIONS</b>							
<b>W</b>	<b>D</b>	<b>H</b>	<b>W</b>	<b>D</b>	<b>H</b>	<b>W</b>	<b>H</b>								
20.5	25	33.25	18	18	17.5	16	16								
<b>RTA 00</b>			4 per carton (pricing and specifications are for one seat unit)												
 <p><b>Armchair w/Tablet</b> COM Yardage: N/A Freight Class: 300 Product Weight: 26 Cubic Feet Per Carton: 14.75</p>	<p>Does not stack.</p>	<b>2075APPT</b> 598	Polypropylene seat & back												
		<b>OVERALL DIMENSIONS</b>			<b>SEAT DIMENSIONS</b>			<b>BACK DIMENSIONS</b>							
		<b>W</b>	<b>D</b>	<b>H</b>	<b>W</b>	<b>D</b>	<b>H</b>	<b>W</b>	<b>H</b>						
		26.5	27.25	33.25	18	18	17	16	16.5						
		<b>RTA 00</b>			1 per carton										

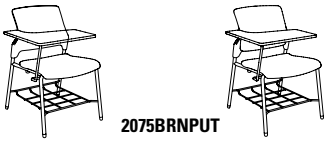

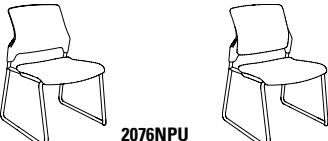

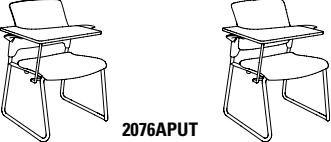

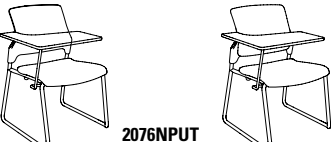



DESCRIPTION	FEATURES	MODEL#	STANDARD TEXTILE GRADES											
			1	2	3	4	5	6	7	8	9	10	11	12
 <p><b>2075APUT</b></p> <p><b>Armless Chair w/Tablet</b> COM Yardage: .75 Freight Class: 250 Product Weight: 31 Cubic Feet Per Carton: 14.75</p>	Does not stack.	<b>2075APUT</b>	733	754	770	795	829	845	877	927	966	1008	1097	1191
			Upholstered seat											
			<b>OVERALL DIMENSIONS</b>			<b>SEAT DIMENSIONS</b>			<b>BACK DIMENSIONS</b>					
			W	D	H	W	D	H	W	H				
26.5	27.25	33.25	18	18	17.5	16	16							
			<b>RTA 00</b>	1 per carton										
 <p><b>2075AUUT</b></p> <p><b>Armless Chair w/Tablet</b> COM Yardage: N/A Freight Class: 300 Product Weight: 26 Cubic Feet Per Carton: 14.75</p>	Does not stack.	<b>2075AUUT</b>	818	839	855	879	913	929	961	1010	1048	1091	1178	1272
			Upholstered seat & back											
			<b>OVERALL DIMENSIONS</b>			<b>SEAT DIMENSIONS</b>			<b>BACK DIMENSIONS</b>					
			W	D	H	W	D	H	W	H				
25	27.25	33.25	18	18	17	16.5	16							
			<b>RTA 00</b>	1 per carton										
 <p><b>2075NPUT</b></p> <p><b>Armless Chair w/Tablet</b> COM Yardage: .75 Freight Class: 300 Product Weight: 29 Cubic Feet Per Carton: 14.75</p>	Does not stack.	<b>2075NPUT</b>	652	672	688	712	746	762	793	842	880	922	1008	1100
			Upholstered seat											
			<b>OVERALL DIMENSIONS</b>			<b>SEAT DIMENSIONS</b>			<b>BACK DIMENSIONS</b>					
			W	D	H	W	D	H	W	H				
25	27.25	33.25	18	18	17.5	16	16.5							
			<b>RTA 00</b>	1 per carton										
 <p><b>2075NUUT</b></p> <p><b>Armless Chair w/Tablet</b> COM Yardage: .75 Freight Class: 300 Product Weight: 29 Cubic Feet Per Carton: 14.75</p>	Does not stack.	<b>2075NUUT</b>	737	757	773	797	830	846	877	925	963	1004	1090	1181
			Upholstered seat & back											
			<b>OVERALL DIMENSIONS</b>			<b>SEAT DIMENSIONS</b>			<b>BACK DIMENSIONS</b>					
			W	D	H	W	D	H	W	H				
25	27.25	33.25	18	18	17.5	16	16.5							
			<b>RTA 00</b>	1 per carton										
 <p><b>2075BRAPP</b></p> <p><b>Armchair w/Backpack Rack</b> COM Yardage: N/A Freight Class: 300 Product Weight: 24 Cubic Feet Per Carton: 14</p>	Does not stack.	<b>2075BRAPP</b>	475											
			Polypropylene seat & back											
			<b>OVERALL DIMENSIONS</b>			<b>SEAT DIMENSIONS</b>			<b>BACK DIMENSIONS</b>					
			W	D	H	W	D	H	W	H				
24	25	33.25	18	18	17	16	16.5							
			<b>RTA 00</b>	1 per carton										
 <p><b>2075BRAPU</b></p> <p><b>Armchair w/Backpack Rack</b> COM Yardage: .75 Freight Class: 300 Product Weight: 27 Cubic Feet Per Carton: 14</p>	Does not stack.	<b>2075BRAPU</b>	610	630	645	668	700	715	745	792	828	868	951	1039
			Upholstered seat											
			<b>OVERALL DIMENSIONS</b>			<b>SEAT DIMENSIONS</b>			<b>BACK DIMENSIONS</b>					
			W	D	H	W	D	H	W	H				
24	25	33.25	18	18	17.5	16	16							
			<b>RTA 00</b>	1 per carton										
 <p><b>2075BRAUU</b></p> <p><b>Armchair w/Backpack Rack</b> COM Yardage: .75 Freight Class: 300 Product Weight: 27 Cubic Feet Per Carton: 14</p>	Does not stack.	<b>2075BRAUU</b>	695	714	730	752	785	800	829	876	912	952	1034	1122
			Upholstered seat & back											
			<b>OVERALL DIMENSIONS</b>			<b>SEAT DIMENSIONS</b>			<b>BACK DIMENSIONS</b>					
			W	D	H	W	D	H	W	H				
24	25	33.25	18	18	17.5	16	16							
			<b>RTA 00</b>	1 per carton										

DESCRIPTION	FEATURES	MODEL#	STANDARD TEXTILE GRADES											
			1	2	3	4	5	6	7	8	9	10	11	12
 <p><b>Armless Chair w/Backpack Rack</b> COM Yardage: N/A Freight Class: 300 Product Weight: 20 Cubic Feet Per Carton: 13</p>	Does not stack.	<b>2075BRNPP</b> 400 Polypropylene seat & back	<b>OVERALL DIMENSIONS</b>			<b>SEAT DIMENSIONS</b>			<b>BACK DIMENSIONS</b>					
		<b>W</b>	<b>D</b>	<b>H</b>	<b>W</b>	<b>D</b>	<b>H</b>	<b>W</b>	<b>H</b>					
		20.5	25	33.25	18	18	18	16	16.5					
  <p><b>2075BRNPU</b>      <b>2075BRNUU</b></p> <p><b>Armless Chair w/Backpack Rack</b> COM Yardage: .75 Freight Class: 300 Product Weight: 23 Cubic Feet Per Carton: 13</p>	Does not stack.	<b>2075BRNPU</b> 535 555 570 592 624 639 668 713 749 788 868 954 Upholstered seat	<b>OVERALL DIMENSIONS</b>			<b>SEAT DIMENSIONS</b>			<b>BACK DIMENSIONS</b>					
		<b>W</b>	<b>D</b>	<b>H</b>	<b>W</b>	<b>D</b>	<b>H</b>	<b>W</b>	<b>H</b>					
		20.5	25	33.25	18	18	17.5	16	16					
		<b>RTA 00</b>	1 per carton											
 <p><b>Armless Chair w/Backpack Rack and Tablet</b> COM Yardage: N/A Freight Class: 23 Product Weight: 29 Cubic Feet Per Carton: 13.5</p>	Does not stack.	<b>2075BRAPPT</b> 709 Polypropylene seat & back	<b>OVERALL DIMENSIONS</b>			<b>SEAT DIMENSIONS</b>			<b>BACK DIMENSIONS</b>					
		<b>W</b>	<b>D</b>	<b>H</b>	<b>W</b>	<b>D</b>	<b>H</b>	<b>W</b>	<b>H</b>					
		26.5	27.25	33.25	18	18	17	16	16.5					
  <p><b>2075BRAPUT</b>      <b>2075BRAUUT</b></p> <p><b>Armchair w/Backpack Rack and Tablet</b> COM Yardage: .75 Freight Class: 250 Product Weight: 35 Cubic Feet Per Carton: 14.75</p>	Does not stack.	<b>2075BRAPUT</b> 844 864 880 904 938 954 985 1034 1071 1113 1199 1292 Upholstered seat	<b>OVERALL DIMENSIONS</b>			<b>SEAT DIMENSIONS</b>			<b>BACK DIMENSIONS</b>					
		<b>W</b>	<b>D</b>	<b>H</b>	<b>W</b>	<b>D</b>	<b>H</b>	<b>W</b>	<b>H</b>					
		26.5	27.25	33.25	18	18	17.5	16	16					
		<b>RTA 00</b>	1 per carton											
 <p><b>Armless Chair w/Backpack Rack and Tablet</b> COM Yardage: N/A Freight Class: 250 Product Weight: 30 Cubic Feet Per Carton: 14.75</p>	Does not stack.	<b>2075BRNPPT</b> 628 Polypropylene seat & back	<b>OVERALL DIMENSIONS</b>			<b>SEAT DIMENSIONS</b>			<b>BACK DIMENSIONS</b>					
		<b>W</b>	<b>D</b>	<b>H</b>	<b>W</b>	<b>D</b>	<b>H</b>	<b>W</b>	<b>H</b>					
		27.25	27.25	33.25	18	18	17	16	16.5					

DESCRIPTION	FEATURES	MODEL#	STANDARD TEXTILE GRADES											
			1	2	3	4	5	6	7	8	9	10	11	12
 <p><b>2075BRNPUT</b>      <b>2075BRNUUT</b></p> <p><b>Armless Chair w/Backpack Rack and Tablet</b> COM Yardage: .75 Freight Class: 250 Product Weight: 32 Cubic Feet Per Carton: 14.75</p>	Does not stack.	<b>2075BRNPUT</b> 763 783 799 822 855 871 901 648 949 1026 1111 1201 Upholstered seat  <b>2075BRNUUT</b> 848 868 883 907 939 955 985 1032 1069 1110 1194 1283 Upholstered seat & back	<b>OVERALL DIMENSIONS</b>			<b>SEAT DIMENSIONS</b>			<b>BACK DIMENSIONS</b>					
			<b>W</b>	<b>D</b>	<b>H</b>	<b>W</b>	<b>D</b>	<b>H</b>	<b>W</b>	<b>H</b>				
			25	27.25	33.25	18	18	17.5	16	16				
		<b>RTA 00</b>	1 per carton											
 <p><b>2076APP</b></p> <p><b>Armchair w/Sled Base</b> COM Yardage: N/A Freight Class: 250 Product Weight: 14 Cubic Feet Per Carton: 14</p>	Stacks 5 high on floor. Stacks 15 high on dolly.	<b>2076APP</b> 409 Polypropylene seat & back	<b>OVERALL DIMENSIONS</b>			<b>SEAT DIMENSIONS</b>			<b>BACK DIMENSIONS</b>					
			<b>W</b>	<b>D</b>	<b>H</b>	<b>W</b>	<b>D</b>	<b>H</b>	<b>W</b>	<b>H</b>				
			25.5	24	33.25	18	18	17	16	16.5				
		<b>RTA 00</b>	4 per carton (pricing and specifications are for one seat unit)											
 <p><b>2076APU</b>      <b>2076AAU</b></p> <p><b>Armchair w/Sled Base</b> COM Yardage: .75 Freight Class: 250 Product Weight: 19.50 Cubic Feet Per Carton: 14</p>	Stacks 5 high on floor. Stacks 10 high on dolly.	<b>2076APU</b> 544 563 577 599 629 644 672 716 750 788 866 950 Upholstered seat  <b>2076AAU</b> 629 649 663 685 716 730 758 802 837 875 953 1037 Upholstered seat & back	<b>OVERALL DIMENSIONS</b>			<b>SEAT DIMENSIONS</b>			<b>BACK DIMENSIONS</b>					
			<b>W</b>	<b>D</b>	<b>H</b>	<b>W</b>	<b>D</b>	<b>H</b>	<b>W</b>	<b>H</b>				
			24	25	33.25	18	18	17.5	16	16				
		<b>RTA 00</b>	4 per carton (pricing and specifications are for one seat unit)											
 <p><b>2076NPP</b></p> <p><b>Armless Chair w/Sled Base</b> COM Yardage: N/A Freight Class: 300 Product Weight: 12 Cubic Feet Per Carton: 13</p>	Stacks 5 high on floor. Stacks 15 high on dolly.	<b>2076NPP</b> 328 Polypropylene seat & back	<b>OVERALL DIMENSIONS</b>			<b>SEAT DIMENSIONS</b>			<b>BACK DIMENSIONS</b>					
			<b>W</b>	<b>D</b>	<b>H</b>	<b>W</b>	<b>D</b>	<b>H</b>	<b>W</b>	<b>H</b>				
			20.5	25	33.25	18	18	18	16	16.5				
		<b>RTA 00</b>	4 per carton (pricing and specifications are for one seat unit)											
 <p><b>2076NPU</b>      <b>2076NUU</b></p> <p><b>Armless Chair w/Sled Base</b> COM Yardage: .75 Freight Class: 250 Product Weight: 15 Cubic Feet Per Carton: 13</p>	Stacks 5 high on floor. Stacks 10 high on dolly.	<b>2076NPU</b> 463 481 494 515 544 558 585 627 660 696 770 850 Upholstered seat  <b>2076NUU</b> 548 566 580 601 630 644 671 714 746 783 858 939 Upholstered seat & back	<b>OVERALL DIMENSIONS</b>			<b>SEAT DIMENSIONS</b>			<b>BACK DIMENSIONS</b>					
			<b>W</b>	<b>D</b>	<b>H</b>	<b>W</b>	<b>D</b>	<b>H</b>	<b>W</b>	<b>H</b>				
			20.5	25	33.25	18	18	17.5	16	16				
		<b>RTA 00</b>	4 per carton (pricing and specifications are for one seat unit)											

DESCRIPTION	FEATURES	MODEL#	STANDARD TEXTILE GRADES											
			1	2	3	4	5	6	7	8	9	10	11	12
 <p><b>Armchair w/Sled Base and Tablet</b> COM Yardage: N/A Freight Class: 300 Product Weight: 27 Cubic Feet Per Carton: 14.75</p>	Does not stack.	<b>2076APPT</b> 643 Polypropylene seat & back	<b>OVERALL DIMENSIONS</b>			<b>SEAT DIMENSIONS</b>			<b>BACK DIMENSIONS</b>					
			<b>W</b>	<b>D</b>	<b>H</b>	<b>W</b>	<b>D</b>	<b>H</b>	<b>W</b>	<b>H</b>				
			26.5	27.25	33.25	18	18	17	16	16.5				
			<b>RTA 00</b>		1 per carton									
 <p><b>2076APUT</b>      <b>2076AUUT</b></p> <p><b>Armchair w/Sled Base and Tablet</b> COM Yardage: .75 Freight Class: 250 Product Weight: 32 Cubic Feet Per Carton: 14.75</p>	Does not stack.	<b>2076APUT</b> 778 799 815 839 874 890 922 972 1010 1053 1141 1235 Upholstered seat  <b>2076AUUT</b> 863 885 901 925 959 975 1006 1056 1094 1136 1224 1317 Upholstered seat & back	<b>OVERALL DIMENSIONS</b>			<b>SEAT DIMENSIONS</b>			<b>BACK DIMENSIONS</b>					
			<b>W</b>	<b>D</b>	<b>H</b>	<b>W</b>	<b>D</b>	<b>H</b>	<b>W</b>	<b>H</b>				
			26.5	27.25	33.25	18	18	17.5	16	16				
			<b>RTA 00</b>		1 per carton									
 <p><b>Armless Chair w/Sled Base and Tablet</b> COM Yardage: N/A Freight Class: 300 Product Weight: 27 Cubic Feet Per Carton: 14.75</p>	Does not stack.	<b>2076NPPT</b> 563 Polypropylene seat & back	<b>OVERALL DIMENSIONS</b>			<b>SEAT DIMENSIONS</b>			<b>BACK DIMENSIONS</b>					
			<b>W</b>	<b>D</b>	<b>H</b>	<b>W</b>	<b>D</b>	<b>H</b>	<b>W</b>	<b>H</b>				
			26.5	27.25	33.25	18	18	17	16	16.5				
			<b>RTA 00</b>		1 per carton									
 <p><b>2076NPUT</b>      <b>2076NUUT</b></p> <p><b>Armless Chair w/Sled Base and Tablet</b> COM Yardage: .75 Freight Class: 250 Product Weight: 30 Cubic Feet Per Carton: 14.75</p>	Does not stack.	<b>2076NPUT</b> 697 718 734 758 792 808 839 888 925 967 1054 1146 Upholstered seat  <b>2076NUUT</b> 782 802 818 842 875 891 921 970 1007 1049 1134 1226 Upholstered seat & back	<b>OVERALL DIMENSIONS</b>			<b>SEAT DIMENSIONS</b>			<b>BACK DIMENSIONS</b>					
			<b>W</b>	<b>D</b>	<b>H</b>	<b>W</b>	<b>D</b>	<b>H</b>	<b>W</b>	<b>H</b>				
			25	27.25	33.25	18	18	17.5	16	16				
			<b>RTA 00</b>		1 per carton									
 <p><b>Bar Stool w/Arms</b> COM Yardage: N/A Freight Class: 300 Product Weight: 25 Cubic Feet Per Carton: 21.50</p>	Stacks 5 high on floor.	<b>2075BSAPP</b> 516 Polypropylene seat & back	<b>OVERALL DIMENSIONS</b>			<b>SEAT DIMENSIONS</b>			<b>BACK DIMENSIONS</b>					
			<b>W</b>	<b>D</b>	<b>H</b>	<b>W</b>	<b>D</b>	<b>H</b>	<b>W</b>	<b>H</b>				
			24	24.75	45	18	18	29	16	16.5				
			<b>RTA 00</b>		2 per carton (pricing and specifications are for one seat unit)									

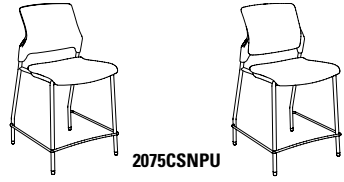
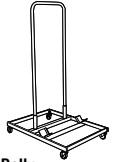
DESCRIPTION	FEATURES	MODEL#	STANDARD TEXTILE GRADES											
			1	2	3	4	5	6	7	8	9	10	11	12
 2075BSAPU	 2075BSAUAU		651	670	685	708	739	754	783	829	865	904	985	1072
			Upholstered seat											
<b>Bar Stool w/Arms</b> COM Yardage: .75 Freight Class: 250 Product Weight: 28 Cubic Feet Per Carton: 21.5	Stacks 5 high on floor.		736	755	770	792	824	839	868	914	949	989	1070	1156
			Upholstered seat & back											
			<b>OVERALL DIMENSIONS</b>			<b>SEAT DIMENSIONS</b>			<b>BACK DIMENSIONS</b>					
			<b>W</b>	<b>D</b>	<b>H</b>	<b>W</b>	<b>D</b>	<b>H</b>	<b>W</b>	<b>H</b>				
			24	24.75	45	18	18	29.5	16	16				
			<b>RTA 00</b>		2 per carton (pricing and specifications are for one seat unit)									
 2075BSNPP			436											
			Polypropylene seat & back											
<b>Armless Bar Stool</b> COM Yardage: N/A Freight Class: 250 Product Weight: 21 Cubic Feet Per Carton: 17.75	Stacks 5 high on floor.		570	589	603	625	655	670	698	742	776	814	893	976
			Upholstered seat											
<b>Armless Bar Stool</b> COM Yardage: N/A Freight Class: 250 Product Weight: 21 Cubic Feet Per Carton: 17.75	Stacks 5 high on floor.		655	675	689	711	742	756	784	829	863	901	980	1063
			Upholstered seat & back											
			<b>OVERALL DIMENSIONS</b>			<b>SEAT DIMENSIONS</b>			<b>BACK DIMENSIONS</b>					
			<b>W</b>	<b>D</b>	<b>H</b>	<b>W</b>	<b>D</b>	<b>H</b>	<b>W</b>	<b>H</b>				
			22	24.75	45	18	18	29	16	16.5				
			<b>RTA 00</b>		2 per carton (pricing and specifications are for one seat unit)									
 2075BSNPU	 2075BSNUU		570	589	603	625	655	670	698	742	776	814	893	976
			Upholstered seat											
<b>Armless Bar Stool</b> COM Yardage: .75 Freight Class: 250 Product Weight: 24 Cubic Feet Per Carton: 17.75	Stacks 5 high on floor.		655	675	689	711	742	756	784	829	863	901	980	1063
			Upholstered seat & back											
			<b>OVERALL DIMENSIONS</b>			<b>SEAT DIMENSIONS</b>			<b>BACK DIMENSIONS</b>					
			<b>W</b>	<b>D</b>	<b>H</b>	<b>W</b>	<b>D</b>	<b>H</b>	<b>W</b>	<b>H</b>				
			22	24.75	45	18	18	29.5	16	16				
			<b>RTA 00</b>		2 per carton (pricing and specifications are for one seat unit)									
 2075CSAPP			516											
			Polypropylene seat & back											
<b>Counter Stool w/Arms</b> COM Yardage: N/A Freight Class: 250 Product Weight: 24 Cubic Feet Per Carton: 21.5	Stacks 5 high on floor.		651	672	688	712	746	763	794	843	882	924	1012	1105
			Upholstered seat											
<b>Counter Stool w/Arms</b> COM Yardage: .75 Freight Class: 250 Product Weight: 27 Cubic Feet Per Carton: 21.5	Stacks 5 high on floor.		736	756	772	796	830	846	877	926	964	1006	1093	1185
			Upholstered seat & back											
			<b>OVERALL DIMENSIONS</b>			<b>SEAT DIMENSIONS</b>			<b>BACK DIMENSIONS</b>					
			<b>W</b>	<b>D</b>	<b>H</b>	<b>W</b>	<b>D</b>	<b>H</b>	<b>W</b>	<b>H</b>				
			24	24.75	40	18	18	24.5	16	16				
			<b>RTA 00</b>		2 per carton (pricing and specifications are for one seat unit)									

DESCRIPTION	FEATURES	MODEL#	STANDARD TEXTILE GRADES													
			1	2	3	4	5	6	7	8	9	10	11	12		
 <p><b>Armless Counter Stool</b> COM Yardage: N/A Freight Class: 250 Product Weight: 20 Cubic Feet Per Carton: 19</p>	Stacks 5 high on floor.	2075CSNPP	436 Polypropylene seat & back													
		<b>OVERALL DIMENSIONS</b>			<b>SEAT DIMENSIONS</b>			<b>BACK DIMENSIONS</b>								
		W	D	H	W	D	H	W	H							
		22	24.75	40	18	18	24	16	16.5							
		RTA 00			2 per carton (pricing and specifications are for one seat unit)											
 <p><b>2075CSNPU</b>      <b>2075CSNUU</b></p> <p><b>Armless Counter Stool</b> COM Yardage: .75 Freight Class: 250 Product Weight: 23 Cubic Feet Per Carton: 19</p>	Stacks 5 high on floor.	2075CSNPU	570	590	606	629	663	679	709	757	795	836	921	1012		
		Upholstered seat														
		2075CSNUU	655	675	691	714	747	763	793	841	878	919	1003	1093		
		Upholstered seat & back														
		<b>OVERALL DIMENSIONS</b>			<b>SEAT DIMENSIONS</b>			<b>BACK DIMENSIONS</b>								
W	D	H	W	D	H	W	H									
22	24.75	40	18	18	24.5	16	16									
RTA 00			2 per carton (pricing and specifications are for one seat unit)													
 <p><b>Dolly</b> COM Yardage: N/A Freight Class: 125 Product Weight: 41 Cubic Feet Per Carton: 6.75</p>	Accommodates 10-15 chairs depending on model.	2085	554													
		<b>OVERALL DIMENSIONS</b>			<b>SEAT DIMENSIONS</b>			<b>BACK DIMENSIONS</b>								
		W	D	H	W	D	H	W	H							
		24	33.5	53												
		RTA 00			2 per carton											
 <p><b>Ganging Clamps - Set of 2</b> COM Yardage: N/A Freight Class: 70 Product Weight: .20 Cubic Feet Per Carton: .04</p>	For use with armchair models. Chair clearance 0.25"	5233	22													
		<b>OVERALL DIMENSIONS</b>			<b>SEAT DIMENSIONS</b>			<b>BACK DIMENSIONS</b>								
		W	D	H	W	D	H	W	H							
		.87	7.75	1.5												
		RTA 00			Pricing is for the set, specifications are for one clamp											
 <p><b>Ganging Brackets - Set of 2</b> COM Yardage: N/A Freight Class: 70 Product Weight: .01 Cubic Feet Per Carton: .01</p>	For use with armless models. Chair clearance 0.25"	6526	17													
		<b>OVERALL DIMENSIONS</b>			<b>SEAT DIMENSIONS</b>			<b>BACK DIMENSIONS</b>								
		W	D	H	W	D	H	W	H							
		.75	5.75	1.25												
		RTA 00			Pricing is for the set, specifications are for one clamp											

TWILIGHT™



model 2194 (BK)



model 2198C (TUN)

STANDARD FEATURES

- Twilight series armchairs and barstools feature a flared back design.
- Chairs can stack 5 high on floor and 8 high on dolly 2125WS. Stools do not stack.
- Comet series tables and connecting brackets are compatible with Twilight models.
- Arm and Armless models can be joined together using ganging clamp model 2180.
- All Twilight models have welded corner gussets for additional strength & support.
- **Specifications and pricing are for 1 chair.**

OPTIONAL FEATURES

- Frames available in Black (BK) or Tungsten (TUN).
- Optional steel cushioned glides (B) are available on all models. Add \$23. Please specify.
- Models featuring a wood veneer back are available in Absolute (AAM), Black (BKM), Cherry (ACM), Espresso Cafe (ECM), English Oak (EOM), Fruitwood (TFM), Gray (HGM), Honey (AHM), Mahogany (TMM), Maple (AVM), Medium Walnut (MWM), Night (ASM), Shaker Cherry (SKM), Walnut (TWM), WC Cream (WTM), White (WHM) and Winter Cherry (WCM). Please Specify. Genuine maple faced veneers and solids are used.
- Models featuring wood veneer backs can incorporate a custom logo. Please contact Customer Service for further details.

DESCRIPTION FEATURES MODEL# STANDARD TEXTILE GRADES



2194



2194WS

**Armchair** Upholstered Back  
COM Yardage: 1.25  
Freight Class: 250  
Product Weight (lbs.): 21  
Cubic Feet Per Carton: 14.25 (2 per carton)

Stacks 5 high on floor.  
Stacks 8 high on dolly.  
Ergonomic Features:  
M, N

	1	2	3	4	5	6	7	8	9	10	11	12
<b>2194</b>	453	487	512	546	600	630	679	749	818	874	1022	1170
<b>2194WS</b> Wall Saver	470	503	532	571	629	648	700	795	840	927	1048	1197

OVERALL DIMENSIONS			SEAT DIMENSIONS			BACK DIMENSIONS	
W	D	H	W	D	H	W	H
23.5	22	35	18	16	18	18	16

RTA 00



**Armchair w/Casters** Upholstered Back  
COM Yardage: 1.25  
Freight Class: 250  
Product Weight (lbs.): 21  
Cubic Feet Per Carton: 12.5 (2 per carton)

Stacks 5 high on floor.  
Stacks 8 high on dolly.  
Ergonomic Features:  
M, N

	1	2	3	4	5	6	7	8	9	10	11	12
<b>2194C</b>	531	563	590	625	679	699	744	834	877	957	1072	1212

OVERALL DIMENSIONS			SEAT DIMENSIONS			BACK DIMENSIONS	
W	D	H	W	D	H	W	H
23.5	22	35	18	16	18	18	18.5

RTA 00



2195



2195WS





**Armless Chair** Upholstered Back  
COM Yardage: 1.25  
Freight Class: 250  
Product Weight (lbs.): 18  
Cubic Feet Per Carton: 12.5 (2 per carton)

Stacks 5 high on floor.  
Stacks 8 high on dolly.  
Ergonomic Features:  
M, N



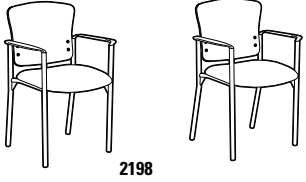

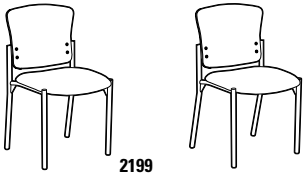
	1	2	3	4	5	6	7	8	9	10	11	12
<b>2195</b>	392	423	448	486	539	567	616	685	754	809	957	1106
<b>2195WS</b> Wall Saver	408	442	469	509	567	588	637	732	777	867	986	1136

OVERALL DIMENSIONS			SEAT DIMENSIONS			BACK DIMENSIONS	
W	D	H	W	D	H	W	H
20	22	35	18	16	18.5	18	16

RTA 00

DESCRIPTION	FEATURES	MODEL#	STANDARD TEXTILE GRADES													
			1	2	3	4	5	6	7	8	9	10	11	12		
 <p><b>Armless Chair w/Caters</b> Upholstered Back COM Yardage: 1.25 Freight Class: 250 Product Weight (lbs.): 18 Cubic Feet Per Carton: 12.25 (2 per carton)</p>	<p>Stacks 5 high on floor. Stacks 8 high on dolly. Ergonomic Features: M, N</p>	<b>2195C</b>	470	501	527	566	618	639	684	774	816	899	1012	1151		
			<b>OVERALL DIMENSIONS</b>			<b>SEAT DIMENSIONS</b>			<b>BACK DIMENSIONS</b>							
			<b>W</b>	<b>D</b>	<b>H</b>	<b>W</b>	<b>D</b>	<b>H</b>	<b>W</b>	<b>H</b>						
			20	22	35	18	16	18	18.5	16						
			<b>RTA 00</b>													
 <p><b>2198</b>                      <b>483WS</b></p> <p><b>Armchair</b> Wood Veneer Back COM Yardage: .75 Freight Class: 250 Product Weight (lbs.): 13 Cubic Feet Per Carton: 6.25 (2 per carton)</p>	<p>Stacks 5 high on floor. Stacks 8 high on dolly. Ergonomic Features: M, N</p>	<b>2198</b>	483	500	517	539	570	589	617	660	700	734	822	910		
			<b>2198WS</b>	498	519	536	560	593	606	636	692	719	773	845	934	
				<b>OVERALL DIMENSIONS</b>			<b>SEAT DIMENSIONS</b>			<b>BACK DIMENSIONS</b>						
				<b>W</b>	<b>D</b>	<b>H</b>	<b>W</b>	<b>D</b>	<b>H</b>	<b>W</b>	<b>H</b>					
23.5	22	35		18	17.5	18	18.5	16.5								
			<b>RTA 00</b>													
 <p><b>Armchair w/Caters</b> Wood Veneer Back COM Yardage: .75 Freight Class: 250 Product Weight (lbs.): 20 Cubic Feet Per Carton: 12.5 (2 per carton)</p>	<p>Stacks 5 high on floor. Stacks 8 high on dolly. Ergonomic Features: M, N</p>	<b>2198C</b>	502	523	539	562	593	604	633	685	710	760	828	912		
			<b>OVERALL DIMENSIONS</b>			<b>SEAT DIMENSIONS</b>			<b>BACK DIMENSIONS</b>							
			<b>W</b>	<b>D</b>	<b>H</b>	<b>W</b>	<b>D</b>	<b>H</b>	<b>W</b>	<b>H</b>						
			23.5	22	35	18	16	18	18.5	16						
			<b>RTA 00</b>													
 <p><b>2199</b>                      <b>2199WS</b></p> <p><b>Armless Chair</b> Wood Veneer Back COM Yardage: .75 Freight Class: 250 Product Weight (lbs.): 18 Cubic Feet Per Carton: 13 (2 per carton)</p>	<p>Stacks 5 high on floor. Stacks 8 high on dolly. Ergonomic Features: M, N</p>	<b>2199</b>	418	436	451	472	503	522	553	594	634	669	757	847		
			<b>2199WS</b>	433	453	470	495	527	541	571	628	655	707	779	870	
				<b>OVERALL DIMENSIONS</b>			<b>SEAT DIMENSIONS</b>			<b>BACK DIMENSIONS</b>						
				<b>W</b>	<b>D</b>	<b>H</b>	<b>W</b>	<b>D</b>	<b>H</b>	<b>W</b>	<b>H</b>					
20	22	35		18	17.5	18	18.5	16.5								
			<b>RTA 00</b>													
 <p><b>Armless Chair w/Caters</b> Wood Veneer Back COM Yardage: .75 Freight Class: 250 Product Weight (lbs.): 18 Cubic Feet Per Carton: 12.5 (2 per carton)</p>	<p>Stacks 5 high on floor. Stacks 8 high on dolly. Ergonomic Features: M, N</p>	<b>2199C</b>	444	465	478	501	535	544	573	627	651	701	769	852		
			<b>OVERALL DIMENSIONS</b>			<b>SEAT DIMENSIONS</b>			<b>BACK DIMENSIONS</b>							
			<b>W</b>	<b>D</b>	<b>H</b>	<b>W</b>	<b>D</b>	<b>H</b>	<b>W</b>	<b>H</b>						
			20	22	35	18	17.5	18	18.5	16						
			<b>RTA 00</b>													



DESCRIPTION	FEATURES	MODEL#	STANDARD TEXTILE GRADES											
			1	2	3	4	5	6	7	8	9	10	11	12
 <p><b>Barstool w/Arms</b> Wood Veneer Back COM Yardage: .75 Freight Class: 300 Product Weight (lbs.): 27 Cubic Feet Per Carton: 14.75 (1 per carton)</p>	<p>Does not stack.</p> <p>Ergonomic Features: M, N</p>	<b>2188</b>	697	718	735	759	795	805	835	894	920	973	1046	1135
			<b>OVERALL DIMENSIONS</b>			<b>SEAT DIMENSIONS</b>			<b>BACK DIMENSIONS</b>					
			<b>W</b>	<b>D</b>	<b>H</b>	<b>W</b>	<b>D</b>	<b>H</b>	<b>W</b>	<b>H</b>				
			23	22	45	18	16	29	18.5	16				
			<b>RTA 00</b>											
 <p><b>Armless Barstool</b> Wood Veneer Back COM Yardage: .75 Freight Class: 300 Product Weight (lbs.): 25 Cubic Feet Per Carton: 14.75 (1 per carton)</p>	<p>Does not stack.</p> <p>Ergonomic Features: M, N</p>	<b>2189</b>	630	652	668	694	727	739	769	827	852	906	978	1069
			<b>OVERALL DIMENSIONS</b>			<b>SEAT DIMENSIONS</b>			<b>BACK DIMENSIONS</b>					
			<b>W</b>	<b>D</b>	<b>H</b>	<b>W</b>	<b>D</b>	<b>H</b>	<b>W</b>	<b>H</b>				
			20	22	45	18	16	29	18.5	16				
			<b>RTA 00</b>											
 <p><b>Barstool w/Arms</b> Upholstered Back COM Yardage: 1.25 Freight Class: 300 Product Weight (lbs.): 28 Cubic Feet Per Carton: 14.75 (1 per carton)</p>	<p>Does not stack.</p> <p>Ergonomic Features: M, N</p>	<b>2196</b>	669	704	731	772	829	849	899	994	1040	1127	1248	1398
			<b>OVERALL DIMENSIONS</b>			<b>SEAT DIMENSIONS</b>			<b>BACK DIMENSIONS</b>					
			<b>W</b>	<b>D</b>	<b>H</b>	<b>W</b>	<b>D</b>	<b>H</b>	<b>W</b>	<b>H</b>				
			23	22	45	18	16	29	18.5	16				
			<b>RTA 00</b>											
 <p><b>Armless Barstool w/</b> Upholstered Back COM Yardage: 1.25 Freight Class: 300 Product Weight (lbs.): 22 Cubic Feet Per Carton: 14.75 (1 per carton)</p>	<p>Does not stack.</p> <p>Ergonomic Features: M, N</p>	<b>2197</b>	603	637	664	703	761	780	831	925	973	1061	1180	1330
			<b>OVERALL DIMENSIONS</b>			<b>SEAT DIMENSIONS</b>			<b>BACK DIMENSIONS</b>					
			<b>W</b>	<b>D</b>	<b>H</b>	<b>W</b>	<b>D</b>	<b>H</b>	<b>W</b>	<b>H</b>				
			20	22	45	18	16	29	18.5	16				
			<b>RTA 00</b>											

VION



VION FINISHES - GUEST SEATING				
Back Frame	Specify Code	Frame	Specify Code	Arm Option
Black	BLK	Black	BK	Fiber Glass Reinforced Nylon (Black)
		Charcoal	CR	
		Fog	FO	
Fog	FOG Add \$55	Tungsten	TN	
		Chrome	CM - Add \$28	

STANDARD FEATURES

- Vion is a comprehensive seating series offering a family of models to Address multiple applications: task, management, conference, guest, heavy duty 24-7, and drafting stools.
- Series offers models with either a mesh or upholstered back.
- Vion guest chairs offer a wall saver frame design, which is constructed from 7/8" diameter steel tubing.
- Vion guest chairs can stack 4 high on the floor.
- Arm design is gently curved and made from strong fiberglass reinforced nylon.
- Guest chairs are standard with durable polypropylene glides.
- Dual wheel carpet casters (**C82**) are standard on guest models with casters.
- Mesh back models are available in 10 colors: Aqua (**MS75**), Black (**MS69**), Black Cherry (**MS76**), Blue (**MS72**), Dust (**MS77**), Ivory (**MS78**), Natural (**MS74**), Paprika (**MS79**), Rope (**MS73**) and Stone (**MS71**).
- Upholstered back models feature Black fabric (**Jenny JN02**) on the back side as standard.
- Upholstery options: fabric, vinyl or leather. Not available in leather/mock leather combination or Crescent fabric.
- Vion beam seating consists of upper seat units (6340-6343) including mounting brackets and all hardware necessary for attachment to beam.
- For all beam components, tables and a complete list of available upper seat units, see Beam seating section.

OPTIONAL FEATURES

- Upholstered back models offer a Matching Outer (**MO**) upholstery option. Due to the additional material needed, these models are listed separately and are priced differently than the standard upholstered back models.
- Seat available in memory foam. Please specify (**MF**). Add \$84.
- Opaque off-white non-marking glides for hard surface flooring are optional for guest chairs, please specify (**NM**). No upcharge.
- Felt glides (**FG**) and rubber glides (**RG**) are available on guest chairs, please specify and add \$42.
- Steel cushioned self-leveling glides (**B**) are available on guest chairs (adds 0.5" to seat height), please specify and add \$23.
- Most guest seating models are available with a tablet. Please specify by adding (**TL**) or (**TR**) to the model code.
- Tablet arms are extremely rugged, suitable for armed forces and student use. Tablet hinges up to allow ease of egress. Tablet slides forward and back to accommodate any body size comfortably. Tablet models do not stack.
- Standard tablet (**D8**) size is 18"D x 14.5"W and is made of Black polymer. Tablets are attached at the left or the right (as seated). Tablet arms not available on stools.
- An optional 18.5"D x 18.5"W high pressure laminate writing tablet is available. The core is hardwood veneer plywood and the edge is bull nosed and finished in clear lacquer. This writing tablet is offered in the following finishes: Black (**D1**), Grey (**D2**), White (**D4**), and Tiger Maple (**D5**). Please specify. Add \$45.
- Dolly available for stacking guest chairs up to 8 high. Specify model 2125WS, 316 List.
- Please refer to chart for optional Arms, Back, Base and Frame finishes.

DESCRIPTION FEATURES MODEL# STANDARD TEXTILE GRADES



**Side Chair - Armless**  
COM Yardage: 1  
Freight Class: 250  
Product Weight (lbs.):24  
Cubic Feet Per Carton: 11.75

Mesh Back  
Stacks 4 high on floor.  
Stacks 8 high on dolly.  
Ergonomic Features:  
M, N

	1	2	3	4	5	6	7	8	9	10	11	12
<b>6324</b>	460	486	506	537	579	596	633	706	741	808	900	1014
<b>6324T</b>	728	759	781	817	867	890	937	1009	1064	1126	1253	1390
<b>6324L</b>	-	-	-	-	-	-	-	643	690	749	849	963
<b>6324LT</b>	-	-	-	-	-	-	-	854	899	946	1045	1150

OVERALL DIMENSIONS			SEAT DIMENSIONS			BACK DIMENSIONS	
W	D	H	W	D	H	W	H
20	24	34.5	19	17.5	17.5	19	17

RTA 00







**Side Chair - Armless w/Casters**  
COM Yardage: 1  
Freight Class: 250  
Product Weight (lbs.):24  
Cubic Feet Per Carton: 11.75





Mesh Back  
Does not stack.  
Ergonomic Features:  
M, N





	1	2	3	4	5	6	7	8	9	10	11	12
<b>6324C</b>	513	539	560	591	633	649	686	760	795	862	953	1067
<b>6324CT</b>	728	752	771	798	837	855	891	949	992	1041	1141	1248
<b>6324CL</b>	-	-	-	-	-	-	-	716	763	822	922	1036
<b>6324CLT</b>	-	-	-	-	-	-	-	926	971	1017	1116	1221





OVERALL DIMENSIONS			SEAT DIMENSIONS			BACK DIMENSIONS	
W	D	H	W	D	H	W	H
20	24	34.5	19	17.5	17.5	19	17



RTA 00

DESCRIPTION	FEATURES	MODEL#	STANDARD TEXTILE GRADES													
			1	2	3	4	5	6	7	8	9	10	11	12		
 <p><b>Side Chair</b> COM Yardage: 1 Freight Class: 300 Product Weight (lbs.): 26 Cubic Feet Per Carton: 13.75</p>	Mesh Back Stacks 4 high on floor. Stacks 8 high on dolly. Ergonomic Features: M, N															
		<b>6325</b>	492	519	539	570	612	629	666	739	774	841	933	1046		
		<b>6325T</b>	718	743	763	792	833	852	889	950	995	1047	1153	1265		
		<b>6325L</b>	-	-	-	-	-	-	-	677	724	782	883	997		
		<b>6325LT</b>	-	-	-	-	-	-	-	888	933	980	1079	1185		
		<b>OVERALL DIMENSIONS</b>			<b>SEAT DIMENSIONS</b>			<b>BACK DIMENSIONS</b>								
		<b>W</b>	<b>D</b>	<b>H</b>	<b>W</b>	<b>D</b>	<b>H</b>	<b>W</b>	<b>H</b>							
		25.5	24	34.5	19	17.5	17.5	19	17							
		<b>RTA 00</b>														
		 <p><b>Side Chair w/Casters</b> COM Yardage: 1 Freight Class: 300 Product Weight (lbs.): 26 Cubic Feet Per Carton: 13.75</p>	Mesh Back Does not stack.  Ergonomic Features: M, N													
<b>6325C</b>	545			572	593	624	666	682	719	793	828	895	986	1100		
<b>6325CT</b>	761			785	804	831	870	888	923	980	1024	1073	1173	1280		
<b>6325CL</b>	-			-	-	-	-	-	-	750	797	855	956	1070		
<b>6325CLT</b>	-			-	-	-	-	-	-	960	1005	1051	1150	1254		
<b>OVERALL DIMENSIONS</b>				<b>SEAT DIMENSIONS</b>			<b>BACK DIMENSIONS</b>									
<b>W</b>	<b>D</b>			<b>H</b>	<b>W</b>	<b>D</b>	<b>H</b>	<b>W</b>	<b>H</b>							
25.5	24			34.5	19	17.5	17.5	19	17							
<b>RTA 00</b>																
 <p><b>Bar Height Stool w/Arms</b> COM Yardage: 1.00 Freight Class: 300 Product Weight (lbs.): 35 Cubic Feet Per Carton: 20</p>	Mesh Back. Does not stack.  Ergonomic Features: M, N															
		<b>6350</b>	640	668	690	724	771	793	836	904	956	1015	1136	1264		
		<b>6350L</b>	-	-	-	-	-	-	-	904	958	1015	1136	1264		
		<b>OVERALL DIMENSIONS</b>			<b>SEAT DIMENSIONS</b>			<b>BACK DIMENSIONS</b>								
		<b>W</b>	<b>D</b>	<b>H</b>	<b>W</b>	<b>D</b>	<b>H</b>	<b>W</b>	<b>H</b>							
		25.5	25	44.5	19	17.5	28.5	18	16							
		<b>RTA 00</b>														
		 <p><b>Armless Bar Height Stool</b> COM Yardage: 1.00 Freight Class: 250 Product Weight (lbs.): 33 Cubic Feet Per Carton: 15.75</p>	Mesh Back. Does not stack.  Ergonomic Features: M, N													
				<b>6351</b>	608	636	659	692	739	761	805	872	924	983	1104	1232
				<b>6351L</b>	-	-	-	-	-	-	-	872	924	983	1104	1232
<b>OVERALL DIMENSIONS</b>				<b>SEAT DIMENSIONS</b>			<b>BACK DIMENSIONS</b>									
<b>W</b>	<b>D</b>			<b>H</b>	<b>W</b>	<b>D</b>	<b>H</b>	<b>W</b>	<b>H</b>							
21	25			44.5	19	17.5	28.5	18	16							
<b>RTA 00</b>																
 <p><b>Counter Height Stool w/Arms</b> COM Yardage: 1.00 Freight Class: 300 Product Weight (lbs.): 25 Cubic Feet Per Carton: 18.5</p>	Mesh Back. Does not stack.  Ergonomic Features: M, N															
				<b>6352</b>	640	668	690	724	771	793	836	904	956	1015	1136	1264
				<b>6352L</b>	-	-	-	-	-	-	-	904	956	1015	1136	1264
		<b>OVERALL DIMENSIONS</b>			<b>SEAT DIMENSIONS</b>			<b>BACK DIMENSIONS</b>								
		<b>W</b>	<b>D</b>	<b>H</b>	<b>W</b>	<b>D</b>	<b>H</b>	<b>W</b>	<b>H</b>							
		25.5	24.5	40.5	19	17.5	24.5	18	16							
		<b>RTA 00</b>														

DESCRIPTION	FEATURES	MODEL#	STANDARD TEXTILE GRADES												
			1	2	3	4	5	6	7	8	9	10	11	12	
 <p><b>Armless Counter Height Stool</b> COM Yardage: 1.00 Freight Class: 250 Product Weight (lbs.): 31 Cubic Feet Per Carton: 14.50</p>	Mesh Back Does not stack.  Ergonomic Features: M, N		608	636	659	692	739	761	805	872	924	983	1104	1232	
		<b>6353</b>	-	-	-	-	-	-	-	872	924	983	1104	1232	
		<b>6353L</b>	-	-	-	-	-	-	-	-	-	-	-	-	-
			OVERALL DIMENSIONS			SEAT DIMENSIONS			BACK DIMENSIONS						
			W	D	H	W	D	H	W	H					
			21	24.5	40.5	19	17.5	24.5	18	16					
			RTA 00												
 <p><b>Side Chair - Armless</b> COM Yardage: 1.25 Freight Class: 250 Product Weight (lbs.): 25 Cubic Feet Per Carton: 11.75</p>	Upholstered Back. Stacks 4 high on floor. Stacks 8 high on dolly. Ergonomic Features: M, N		503	530	551	580	624	640	677	750	785	851	943	1058	
		<b>6334</b>	545	597	639	700	786	817	894	1038	1108	1243	1426	1653	
		<b>6334L</b>	-	-	-	-	-	-	-	-	704	751	810	910	1024
		<b>6334LMO</b>	-	-	-	-	-	-	-	-	968	1061	1179	1379	1607
			OVERALL DIMENSIONS			SEAT DIMENSIONS			BACK DIMENSIONS						
			W	D	H	W	D	H	W	H					
			20	24	34.5	19	17.5	17.5	19	17					
			RTA 00												
 <p><b>Side Chair - Armless</b> COM Yardage: 1.25 Freight Class: 250 Product Weight (lbs.): 25 Cubic Feet Per Carton: 11.75</p>	Upholstered Back. Does not stack. <b>Specify (L) left or (R) right tablet</b> <b>(Example: 6334TL or 6334TR).</b> Ergonomic Features: M, N		752	786	813	852	910	937	988	1071	1135	1205	1350	1504	
		<b>6334T</b>	794	847	889	954	1045	1087	1170	1300	1400	1513	1743	1989	
		<b>6334MO</b>	-	-	-	-	-	-	-	-	918	973	1034	1158	1290
		<b>6334LT</b>	-	-	-	-	-	-	-	-	1195	1288	1392	1604	1831
			OVERALL DIMENSIONS			SEAT DIMENSIONS			BACK DIMENSIONS						
			W	D	H	W	D	H	W	H					
			20	24	34.5	19	17.5	17.5	19	17					
			RTA 00												
 <p><b>Side Chair w/Casters</b> COM Yardage: 1.25 Freight Class: 250 Product Weight (lbs.): 25 Cubic Feet Per Carton: 11.75</p>	Upholstered Back. Does not stack. <b>Specify (L) left or (R) right tablet</b> <b>(Example: 6334TL or 6334TR).</b> Ergonomic Features: M, N		562	589	609	640	682	699	736	809	844	910	1003	1116	
		<b>6334C</b>	603	654	696	757	843	874	950	1095	1164	1299	1483	1709	
		<b>6324CL</b>	-	-	-	-	-	-	-	-	840	886	945	1046	1159
		<b>6324CLMO</b>	-	-	-	-	-	-	-	-	1047	1141	1259	1459	1687
			OVERALL DIMENSIONS			SEAT DIMENSIONS			BACK DIMENSIONS						
			W	D	H	W	D	H	W	H					
			20	24	34.5	19	17.5	17.5	19	17					
			RTA 00												
 <p><b>Side Chair w/Casters</b> COM Yardage: 1.25 Freight Class: 250 Product Weight (lbs.): 25 Cubic Feet Per Carton: 11.75</p>	Upholstered Back. Does not stack. <b>Specify (L) left or (R) right tablet</b> <b>(Example: 6334CTL or 6334CTR).</b> Ergonomic Features: M, N		798	830	855	894	948	973	1022	1100	1159	1226	1363	1509	
		<b>6334CT</b>	837	888	927	989	1074	1115	1192	1317	1412	1518	1737	1970	
		<b>6324CLT</b>	-	-	-	-	-	-	-	-	1069	1127	1192	1326	1468
		<b>6324CLMO</b>	-	-	-	-	-	-	-	-	1274	1367	1469	1681	1907
			OVERALL DIMENSIONS			SEAT DIMENSIONS			BACK DIMENSIONS						
			W	D	H	W	D	H	W	H					
			20	24	34.5	19	17.5	17.5	19	17					
			RTA 00												

DESCRIPTION	FEATURES	MODEL#	STANDARD TEXTILE GRADES													
			1	2	3	4	5	6	7	8	9	10	11	12		
 <p><b>Side Chair</b> COM Yardage: 1.25 Freight Class: 300 Product Weight (lbs.): 27 Cubic Feet Per Carton: 13.75</p>	Upholstered Back. Stacks 4 high on floor. Stacks 8 high on dolly. Ergonomic Features: M, N	<b>6335</b>	536	563	585	614	658	673	710	784	818	885	977	1091		
		<b>6335MO</b>	578	630	671	733	818	850	925	1071	1141	1276	1459	1687		
		<b>6335L</b>	-	-	-	-	-	-	-	793	840	899	999	1113		
		<b>6335LMO</b>	-	-	-	-	-	-	-	1000	1094	1212	1412	1640		
		<b>OVERALL DIMENSIONS</b>			<b>SEAT DIMENSIONS</b>			<b>BACK DIMENSIONS</b>								
		W D H			W D H			W H								
		25.5 24 34.5			19 17.5 17.5			19 17								
		<b>RTA 00</b>														
		 <p><b>Side Chair</b> COM Yardage: 1.25 Freight Class: 300 Product Weight (lbs.): 27 Cubic Feet Per Carton: 13.75</p>	Upholstered Back. Does not stack <b>Specify (L) left or (R) right tablet (Example: 6335TL or 6335TR).</b> Ergonomic Features: M, N	<b>6335T</b>	781	815	842	881	938	964	1015	1096	1159	1229	1372	1525
				<b>6335MO</b>	823	877	918	981	1071	1114	1194	1324	1424	1535	1763	2007
<b>6335LT</b>	-			-	-	-	-	-	-	1022	1081	1145	1280	1423		
<b>6335LMO</b>	-			-	-	-	-	-	-	1227	1320	1423	1634	1861		
<b>OVERALL DIMENSIONS</b>				<b>SEAT DIMENSIONS</b>			<b>BACK DIMENSIONS</b>									
W D H				W D H			W H									
25.5 24 34.5				19 17.5 17.5			19 17									
<b>RTA 00</b>																
 <p><b>Side Chair w/Casters</b> COM Yardage: 1.25 Freight Class: 300 Product Weight (lbs.): 27 Cubic Feet Per Carton: 13.75</p>	Upholstered Back. Does not stack.  Ergonomic Features: M, N			<b>6335C</b>	595	622	642	672	715	732	769	842	877	943	1035	1150
				<b>6335CMO</b>	635	686	728	789	876	907	982	1127	1197	1332	1516	1743
		<b>6335CL</b>	-	-	-	-	-	-	-	872	919	978	1079	1192		
		<b>6335CLMO</b>	-	-	-	-	-	-	-	1080	1174	1291	1491	1720		
		<b>OVERALL DIMENSIONS</b>			<b>SEAT DIMENSIONS</b>			<b>BACK DIMENSIONS</b>								
		W D H			W D H			W H								
		25.5 24 34.5			19 18 17.5			19 17								
		<b>RTA 00</b>														
		 <p><b>Side Chair w/Casters</b> COM Yardage: 1.25 Freight Class: 300 Product Weight (lbs.): 27 Cubic Feet Per Carton: 13.75</p>	Upholstered Back. Does not stack. <b>Specify (L) left or (R) right tablet (Example: 6335CTL or 6335CTR)</b> Ergonomic Features: M, N	<b>6335CT</b>	829	861	885	923	977	1003	1050	1127	1188	1253	1390	1535
				<b>6335CMO</b>	868	918	958	1018	1104	1144	1221	1344	1439	1544	1761	1994
<b>6335CLT</b>	-			-	-	-	-	-	-	1101	1159	1224	1357	1499		
<b>6335CLMO</b>	-			-	-	-	-	-	-	1306	1398	1501	1712	1937		
<b>OVERALL DIMENSIONS</b>				<b>SEAT DIMENSIONS</b>			<b>BACK DIMENSIONS</b>									
W D H				W D H			W H									
25.5 24 34.5				19 18 17.5			19 17									
<b>RTA 00</b>																
 <p><b>Armless Seat Unit</b> COM Yardage: 1 Freight Class: 250 Product Weight (lbs.): 20 Cubic Feet Per Carton: 7.25</p>	Upholstered Seat and Mesh Back. Use with beam.			<b>6340</b>	564	590	610	641	684	704	744	806	854	908	1018	1136
				<b>OVERALL DIMENSIONS</b>			<b>SEAT DIMENSIONS</b>			<b>BACK DIMENSIONS</b>						
		W D H			W D H			W H								
		21 23.5 20.5			17.5 18 -			19 17								
<b>RTA 00</b>																

DESCRIPTION	FEATURES	MODEL#	STANDARD TEXTILE GRADES													
			1	2	3	4	5	6	7	8	9	10	11	12		
 <p><b>Armless Seat Unit</b> COM Yardage: 1 Freight Class: 250 Product Weight (lbs.): 20 Cubic Feet Per Carton: 7.25</p>	Upholstered Seat and Back. Use with beam.	6341	718	753	781	823	882	909	963	1049	1115	1188	1337	1498		
			<b>OVERALL DIMENSIONS</b>			<b>SEAT DIMENSIONS</b>			<b>BACK DIMENSIONS</b>							
			<b>W</b>	<b>D</b>	<b>H</b>	<b>W</b>	<b>D</b>	<b>H</b>	<b>W</b>	<b>H</b>						
			21	23.5	20.5	17.5	18	-	19	17						
			<b>RTA 00</b>													
 <p><b>Seat Unit w/Arms</b> COM Yardage: 1 Freight Class: 250 Product Weight (lbs.): 21 Cubic Feet Per Carton: 9.75</p>	Upholstered Seat and Mesh Back. Use with beam.	6342	571	599	622	655	702	724	768	835	887	946	1067	1195		
			<b>OVERALL DIMENSIONS</b>			<b>SEAT DIMENSIONS</b>			<b>BACK DIMENSIONS</b>							
			<b>W</b>	<b>D</b>	<b>H</b>	<b>W</b>	<b>D</b>	<b>H</b>	<b>W</b>	<b>H</b>						
			25.5	23.5	20.5	17.5	18	-	19	17						
			<b>RTA 00</b>													
 <p><b>Seat Unit w/Arms</b> COM Yardage: 1 Freight Class: 250 Product Weight (lbs.): 21 Cubic Feet Per Carton: 9.75</p>	Upholstered Seat and Back. Use with beam.	6343	660	695	723	764	823	850	904	989	1055	1128	1279	1439		
			<b>OVERALL DIMENSIONS</b>			<b>SEAT DIMENSIONS</b>			<b>BACK DIMENSIONS</b>							
			<b>W</b>	<b>D</b>	<b>H</b>	<b>W</b>	<b>D</b>	<b>H</b>	<b>W</b>	<b>H</b>						
			25.5	23.5	20.5	17.5	18	-	19	17						
			<b>RTA 00</b>													
 <p><b>Bar Height Stool w/Arms</b> COM Yardage: 1.25 Freight Class: 300 Product Weight (lbs.): 35 Cubic Feet Per Carton: 20</p>	Upholstered Back Does not stack.	6360	697	732	760	801	861	887	941	1026	1092	1166	1316	1476		
			<b>6360MO</b>	738	794	839	905	999	1044	1130	1266	1371	1488	1729	1986	
				<b>6360L</b>	-	-	-	-	-	-	-	1026	1092	1166	1316	1476
					<b>6360LMO</b>	-	-	-	-	-	-	-	1266	1371	1488	1729
<b>OVERALL DIMENSIONS</b>			<b>SEAT DIMENSIONS</b>			<b>BACK DIMENSIONS</b>										
<b>W</b>	<b>D</b>	<b>H</b>	<b>W</b>	<b>D</b>	<b>H</b>	<b>W</b>	<b>H</b>									
25.5	25	44.5	19	17.5	28.5	18	16									
			<b>RTA 00</b>													
 <p><b>Armless Bar Height Stool</b> COM Yardage: 1.25 Freight Class: 250 Product Weight (lbs.): 33 Cubic Feet Per Carton: 15.75</p>	Upholstered Back Does not stack.	6361	666	701	730	771	831	858	912	997	1063	1137	1286	1447		
			<b>6361MO</b>	707	763	808	874	969	1013	1100	1235	1341	1458	1699	1955	
				<b>6361L</b>	-	-	-	-	-	-	-	997	1063	1137	1286	1447
					<b>6361LMO</b>	-	-	-	-	-	-	-	1235	1341	1458	1699
<b>OVERALL DIMENSIONS</b>			<b>SEAT DIMENSIONS</b>			<b>BACK DIMENSIONS</b>										
<b>W</b>	<b>D</b>	<b>H</b>	<b>W</b>	<b>D</b>	<b>H</b>	<b>W</b>	<b>H</b>									
21	25	44.5	19	17.5	28.5	18	16									
			<b>RTA 00</b>													

DESCRIPTION	FEATURES	MODEL#	STANDARD TEXTILE GRADES																							
			1	2	3	4	5	6	7	8	9	10	11	12												
 <p><b>Bar Counter Height Stool w/Arms</b>                      COM Yardage: 1.25                      Freight Class: 300                      Product Weight (lbs.): 33                      Cubic Feet Per Carton: 18.5</p>	Upholstered Back Does not stack.  Ergonomic Features: M, N																									
		<b>6362</b>	697	732	760	801	861	887	941	1026	1092	1166	1316	1476												
		<b>6362MO</b>	738	794	839	905	999	1044	1130	1266	1371	1488	1729	1986												
		<b>6362L</b>	-	-	-	-	-	-	-	1026	1092	1166	1316	1476												
		<b>6362LMO</b>	-	-	-	-	-	-	-	1266	1371	1488	1729	1986												
		<b>OVERALL DIMENSIONS</b>			<b>SEAT DIMENSIONS</b>			<b>BACK DIMENSIONS</b>																		
		<b>W</b>	<b>D</b>	<b>H</b>	<b>W</b>	<b>D</b>	<b>H</b>	<b>W</b>	<b>H</b>																	
		25.5	24.5	40.5	19	17.5	24.5	18	16																	
		 <p><b>Armless Counter Height Stool</b>                      COM Yardage: 1.25                      Freight Class: 250                      Product Weight (lbs.): 31                      Cubic Feet Per Carton: 14.50</p>	Upholstered Back Does not stack.  Ergonomic Features: M, N																							
<b>6363</b>	666			701	730	771	831	858	912	997	1063	1137	1286	1447												
<b>6363MO</b>	707			763	808	874	969	1013	1100	1235	1341	1458	1699	1955												
<b>6363L</b>	-			-	-	-	-	-	-	997	1063	1137	1286	1447												
<b>6363LMO</b>	-			-	-	-	-	-	-	1235	1341	1458	1699	1955												
<b>OVERALL DIMENSIONS</b>				<b>SEAT DIMENSIONS</b>			<b>BACK DIMENSIONS</b>																			
<b>W</b>	<b>D</b>			<b>H</b>	<b>W</b>	<b>D</b>	<b>H</b>	<b>W</b>	<b>H</b>																	
21	25			40.5	19	17.5	24.5	18	16																	

RTA 00

RTA 00

ZOMA™



model 6656



model 6657







STANDARD FEATURES

- Design sensitive guest seating featuring a wide flat, flared arms and elliptical tubular construction.
- The back of the chair is heavily compound curved to provide comfort and support in multiple seating positions.
- No visible back attachment hardware. Backs are attached using concealed hardware only.
- The outer back is upholstered in the same material selection as the rest of the chair.
- Arms are wide and full length, offering support to help stabilize the user as they sit in or exit chairs.
- The gently curved arms are made from incredibly strong black fiberglass reinforced nylon.
- The rugged frame is made from welded elliptical (oval) steel tubing 1.5" wide.
- Chairs are "Wall Safe," rear legs hit the baseboard first leaving clearance between the back of the chair and the wall; Thus saving both the chair and the wall from damage. Legs flair out to the rear to provide additional support.

- Zoma is equipped with a polypropylene seat shroud that helps stabilize chairs when stacked and avoid frame imprints on upholstered seats.
- Stacks up to 4 high on the floor or on a dolly (2125WS).
- Standard glide is a durable Black Polypropylene oval glide.

OPTIONAL FEATURES

- Frame is standard in a choice of Black (BLK) or Tungsten (TUN) Finish must be specified. A chrome frame is optionally available. Please Specify (CH), add \$30.
- A durable polypropylene outer back shroud is available at no charge. Optional shroud is Black only. Please specify (PSB).
- For chairs used on hard surface floors PLEASE SPECIFY Opaque (off White), Non-Marking Glides (NM).
- Available in all standard GLOBAL carded fabrics with the EXCEPTION of Couture, Jenny, Match, and Replay.

DESCRIPTION	FEATURES	MODEL#	STANDARD TEXTILE GRADES													
			1	2	3	4	5	6	7	8	9	10	11	12		
 <p><b>Armchair</b> COM Yardage: 1.25 Freight Class: 250 Product Weight (lbs.): 28 Cubic Feet Per Carton: 13.75</p>	Stacks 4 high on floor or dolly.  Ergonomic Features: M, N	<b>6656</b>	452	485	511	548	603	623	670	760	804	887	1003	1145		
			<b>OVERALL DIMENSIONS</b> W D H			<b>SEAT DIMENSIONS</b> W D H			<b>BACK DIMENSIONS</b> W H							
			26.5	24	32.5	20	19	17	18	15						
			RTA 00 													
 <p><b>Armless Side Chair</b> COM Yardage: 1.25 Freight Class: 250 Product Weight (lbs.): 26 Cubic Feet Per Carton: 11.75</p>	Stacks 4 high on floor or dolly.  Ergonomic Features: M, N	<b>6657</b>	412	444	470	507	563	581	630	720	764	848	961	1105		
			<b>OVERALL DIMENSIONS</b> W D H			<b>SEAT DIMENSIONS</b> W D H			<b>BACK DIMENSIONS</b> W H							
			22.5	24	32.5	20	19	17	18	15						
			RTA 00 													
 <p><b>Dolly</b> COM Yardage: N/A Freight Class: 150 Product Weight (lbs.): 16 Cubic Feet Per Carton: 3.80</p>		<b>2125WS</b>	316	-	-	-	-	-	-	-	-	-	-	-		
			<b>OVERALL DIMENSIONS</b> W D H			<b>SEAT DIMENSIONS</b> W D H			<b>BACK DIMENSIONS</b> W H							
			23.25	24.75	12.25	-	-	-	-	-						
			RTA 1 													



ZOOEY™



model 8585

STANDARD FEATURES

- Side chair with upholstered seat and mesh back.
- The breathable mesh back allows continuous air flow to eliminate heat build-up.
- Black (BK) frame is standard.
- Standard with polypropylene armcaps.
- Glides are non-marking polypropylene, suitable for both carpet and hard surface flooring.
- Does not stack.
- Upholstery options (seat): fabric, vinyl or leather

OPTIONAL FEATURES

- Mesh back is available in 24 standard Vue Mesh colors.
- Seats can be color coordinated to the mesh backs, with grade 2 "Match" fabric.
- Optional Tungsten (TU) frame, Add \$47 or Chrome (CH) frame, Add \$99.

Please specify option models in the following order:

- **Model number**  
8585 Four-legged side chair
- **Frame finish**  
(BK) Black. No Upcharge.  
(TU) Tungsten. Add \$47.  
(CH) Chrome. Add \$99.
- **Textile**  
Specify textile code for seat
- **Mesh**  
(VU10) Sandy Beach  
(VU11) Desert Sand  
(VU12) Orange Sunset  
(VU13) Chocolate Fountain  
(VU14) Artic Blue  
(VU15) Quarry Grey  
(VU16) Tidal Wave  
(VU17) Ivy Moss  
(VU18) Red Rose  
(VU19) Coal Black  
(VU20) White  
(VU21) Lime  
(VU22) Chartreuse  
(VU26) Poolblue  
(VU28) Sky  
(VU32) Primary Blue  
(VU34) Tangerine  
(VU37) (VU37) Paprika  
(VU40) (VU40) Grain  
(VU43) (VU43) Yellow  
(VU55) (VU55) Silver Grey  
(VU63) (VU63) Silver  
(VU65) (VU65) Hot Pink  
(VU70) (VU70) Red Mittens

EXAMPLE OF ZOOEY ORDER CODE:

8585	-BK	-HD08	-VU19
Model Number	Finish	Textile	Mesh

DESCRIPTION	FEATURES	MODEL#	STANDARD TEXTILE GRADES												
			1	2	3	4	5	6	7	8	9	10	11	12	
 <p><b>Mesh Back Side Chair</b> COM Yardage: .1 Freight Class: 250 Product Weight (lbs.): 46 Cubic Feet Per Carton: 15.73</p>	<p>Does not stack.</p> <p>Ergonomic Features: M, N</p>	8585	733	751	767	788	818	831	858	909	935	982	1048	1130	
		<p><b>OVERALL DIMENSIONS</b></p> <p>W D H</p>			<p><b>SEAT DIMENSIONS</b></p> <p>W D H</p>			<p><b>BACK DIMENSIONS</b></p> <p>W H</p>							
			23.5	27.5	35	19	17.5	17				20	18		
			<p>RTA 00</p>												

# lounge

Ballara .....	240	Jeo .....	240	River HT .....	312
Braden .....	285	Kate .....	288	River+ .....	324
Bridges II Collaborative Seating .....	254	Lux .....	289	Sirena .....	344
Camino .....	261	ML .....	291	Vitrola .....	348
Citi .....	266	ML Park .....	293	Wind .....	350
Citi Square .....	271	Orion .....	294	Wind Linear .....	352
Dawson .....	280	Prairie .....	295		
Drift .....	281	River .....	296		

**BALLARA™**



model 9751

model 9751NA & 9757L



**Quilted Seat Option**  
See optional features for more details.



model 9752NA Two Seat Sofa, 9755 Corner Table, 9751NA Lounge Chair, 9757L Left Tablet

**STANDARD FEATURES**

- An all inclusive, modular series which includes seating, storage, power, tables and tablets.
- Fulfill many space planning scenarios including corner, in-line, open concept as well as traditional reception.
- Furniture pieces, seating or tables can be used as stand alone items or linked together with ganging brackets to create infinite configurations.
- Four high back (banquette) models available in two different heights (42" or 48") and two sizes (two-seat or three-seat armless sofas).
- Banquettes are available as table back models (TB) which are equipped with an 8" laminate back table shelf.
- Tablets can be mounted outside or between seats to accommodate various work and collaborative settings. Tablets have a 14" round surface and come with a 2-point locking mechanism for easy handling and stability.
- Fixed cushions are accented by a metal base and frame. Frames are standard in Black (BLK).
- Table frames and Tablet metal components are standard in Black (BLK). Tables features durable and matching 3mm edges.
- Ganging brackets and power modules are standard in Black (BLK).
- Power modules include one power outlet and two USB ports and can be mounted under any seat or table. Wire management is included.

- All models are standard with Black polypropylene foot glides.
- **OPTIONAL FEATURES**
- Quilted Seat (Q) is available. Backless stools, add \$78 each. Single seat models, add \$154. Two seater sofa, add \$306. Three seater sofa, add \$460.
- All chair frames, table frames, tablet metal components, ganging brackets and power modules are available in the following optional finishes at no upcharge: Designer White (DWT) or Tungsten (TUN). Optional finishes Chrome (CH) or Brushed Chrome (BC) are available with an upcharge. Add \$164 for counter height and bar height stools. Add \$177 for single seat lounge chairs. Add \$235 for two seat sofas. Add \$294 for three seat sofas. Add \$177 for storage/end tables. Add \$235 for storage/coffee tables. Add \$89 for tablets. Add \$21 for Ganging brackets. Add \$16 for power modules.
- Corner tables, storage tables and tablets are offered in the following laminate finishes: Absolute Acajou (ACJ), Asian Night (ASN), Avant Cherry (AWC), Avant Honey (AWH), Black (BLK), Brushed Cobalt (BRC), Clear Maple (CMB), Dark Espresso (DES), Designer White (DWT), Hayden Grey (HGT), Quartered Mahogany (QTM), Storm Grey (SOG), Tiger Fruitwood (TFW), Tiger Walnut (TWL), Walnut Heights (WHE), White Chocolate (WHC), Willow Grey (WGY), and Winter Cherry (WCR).

**SAMPLE LAYOUTS**

**Layout A**



Qty	Model Number	Description	Dimensions	List Price
1	9751L	Lounge Chair - Left Arm	28.5 x 29.5 x 30	1481
1	9751R	Lounge Chair - Right Arm	28.5 x 29.5 x 30	1481
1	9755	Corner Table	27.25 x 27.25 x 16.5	589

**SAMPLE LAYOUT TOTAL IN STANDARD BLACK FRAME 3551**  
**SAMPLE LAYOUT TOTAL IN OPTIONAL FRAME FINISHES 4082**

**Layout B**



Qty	Model Number	Description	Dimensions	List Price
1	9751L	Lounge Chair - Left Arm	28.5 x 29.5 x 30	1481
1	9751R	Lounge Chair - Right Arm	28.5 x 29.5 x 30	1481
1	9755	Corner Table	27.25 x 27.25 x 16.5	589

**SAMPLE LAYOUT TOTAL IN STANDARD BLACK FRAME 3551**  
**SAMPLE LAYOUT TOTAL IN OPTIONAL FRAME FINISHES 4082**

**Layout C**

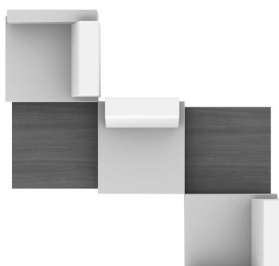

Qty	Model Number	Description	Dimensions	List Price
1	9751L	Lounge Chair - Left Arm	28.5 x 29.5 x 30	1481
1	9751R	Lounge Chair - Right Arm	28.5 x 29.5 x 30	1481
1	9751NA	Lounge Chair - No Arms	27.5 x 29.5 x 30	1228
2	9755	Corner Table	27.25 x 27.25 x 16.5	589 x 2

**SAMPLE LAYOUT TOTAL IN STANDARD BLACK FRAME 5368**  
**SAMPLE LAYOUT TOTAL IN OPTIONAL FRAME FINISHES 6253**

**SAMPLE LAYOUTS**

**Layout D**



Qty	Model Number	Description	Dimensions	List Price
1	<b>9751L</b>	Lounge Chair - Left Arm	28.5 x 29.5 x 30	1481
1	<b>9751R</b>	Lounge Chair - Right Arm	28.5 x 29.5 x 30	1481
1	<b>9751NA</b>	Lounge Chair - Armless	27.5 x 29.5 x 30	1228
2	<b>9755</b>	Corner Table	27.25 x 27.25 x 16.5	589 x 2
1	<b>9757L</b>	Left Tablet	14 x 14 x 17.25	453
1	<b>9758R</b>	Right Tablet	14 x 14 x 17.25	453

**SAMPLE LAYOUT TOTAL IN STANDARD BLACK FRAME 6274**  
**SAMPLE LAYOUT TOTAL IN OPTIONAL FRAME FINISHES 7337**

**Layout E**



Qty	Model Number	Description	Dimensions	List Price
1	<b>9752L-OB</b>	Two Seat Sofa Open Back - Left Arm	55 x 29.5 x 30	2415
1	<b>9752NA</b>	Two Seat Sofa - Armless	54 x 29.5 x 30	2219
1	<b>9754</b>	Storage Table	27.25 x 27.25 x 16.5	936
1	<b>9755</b>	Corner Table	27.25 x 27.25 x 16.5	589
1	<b>9757L</b>	Left Tablet	14 x 14 x 17.25	453

**SAMPLE LAYOUT TOTAL IN STANDARD BLACK FRAME 6612**  
**SAMPLE LAYOUT TOTAL IN OPTIONAL FRAME FINISHES 7583**

**Layout F**

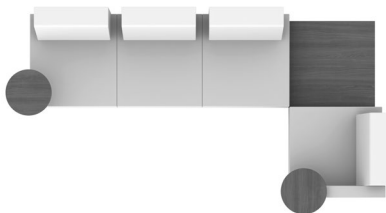

Qty	Model Number	Description	Dimensions	List Price
1	<b>9753NA-OB</b>	Three Seat Sofa Open Back - Armless	80.5 x 29.5 x 30	3110
1	<b>9751L</b>	Lounge Chair - Left Arm	28.5 x 29.5 x 30	1481
1	<b>9755</b>	Corner Table	27.25 x 27.25 x 16.5	589
1	<b>9757L</b>	Left Tablet	14 x 14 x 17.25	453
1	<b>9758R</b>	Right Tablet	14 x 14 x 17.25	453

**SAMPLE LAYOUT TOTAL IN STANDARD BLACK FRAME 6086**  
**SAMPLE LAYOUT TOTAL IN OPTIONAL FRAME FINISHES 6912**

**Layout G**



Qty	Model Number	Description	Dimensions	List Price
1	<b>9753NA-OB</b>	Three Seat Sofa Open Back - Armless	80.5 x 29.5 x 30	3110
1	<b>9751</b>	Lounge Chair	29.5 x 29.5 x 30	1733
1	<b>9755</b>	Corner Table	27.25 x 27.25 x 16.5	589
1	<b>9757L</b>	Left Tablet	14 x 14 x 17.25	453

**SAMPLE LAYOUT TOTAL IN STANDARD BLACK FRAME 5885**  
**SAMPLE LAYOUT TOTAL IN OPTIONAL FRAME FINISHES 6622**

**Layout H**

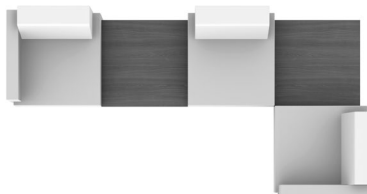

Qty	Model Number	Description	Dimensions	List Price
1	<b>9751L</b>	Lounge Chair - Left Arm	28.5 x 29.5 x 30	1481
1	<b>9751R</b>	Lounge Chair - Right Arm	28.5 x 29.5 x 30	1481
1	<b>9751NA</b>	Lounge Chair - No Arms	27.5 x 29.5 x 30	1228
2	<b>9755</b>	Corner Table	27.25 x 27.25 x 16.5	589 x 2

**SAMPLE LAYOUT TOTAL IN STANDARD BLACK FRAME 5368**  
**SAMPLE LAYOUT TOTAL IN OPTIONAL FRAME FINISHES 6253**

**SAMPLE LAYOUTS**

**Layout I**

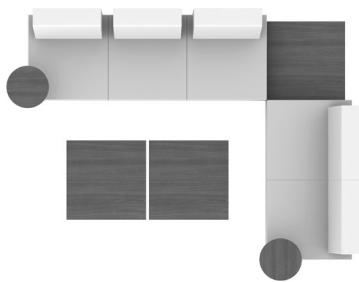

Qty	Model Number	Description	Dimensions	List Price
1	<b>9753NA-OB</b>	Three Seat Sofa Open Back - Armless	80.5 x 29.5 x 30	3110
1	<b>9752NA</b>	Two Seat Sofa - Armless	54 x 29.5 x 30	2219
2	<b>9754</b>	Storage Table	27.25 x 27.25 x 16.5	936 x 2
1	<b>9755</b>	Corner Table	27.25 x 27.25 x 16.5	589
1	<b>9757L</b>	Left Tablet	14 x 14 x 17.25	453
1	<b>9758R</b>	Right Tablet	14 x 14 x 17.25	453

**SAMPLE LAYOUT TOTAL IN STANDARD BLACK FRAME 8696**  
**SAMPLE LAYOUT TOTAL IN OPTIONAL FRAME FINISHES 10050**

**Layout J**

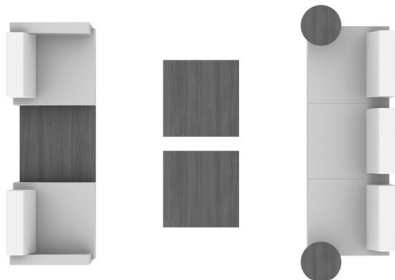

Qty	Model Number	Description	Dimensions	List Price
1	<b>9753NA-OB</b>	Three Seat Sofa Open Back - Armless	80.5 x 29.5 x 30	3110
1	<b>9751L</b>	Lounge Chair - Left Arm	28.5 x 29.5 x 30	1481
1	<b>9751R</b>	Lounge Chair - Right Arm	28.5 x 29.5 x 30	1481
2	<b>9754</b>	Storage Table	27.25 x 27.25 x 16.5	936 x2
1	<b>9755</b>	Corner Table	27.25 x 27.25 x 16.5	589
1	<b>9757L</b>	Left Tablet	14 x 14 x 17.25	453
1	<b>9758R</b>	Right Tablet	14 x 14 x 17.25	453

**SAMPLE LAYOUT TOTAL IN STANDARD BLACK FRAME 9439**  
**SAMPLE LAYOUT TOTAL IN OPTIONAL FRAME FINISHES 10912**

**Layout K**

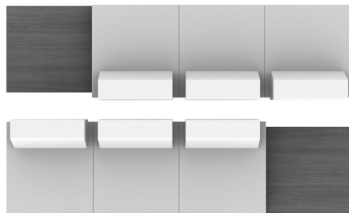

Qty	Model Number	Description	Dimensions	List Price
2	<b>9753NA-OB</b>	Three Seat Sofa Open Back - Armless	80.5 x 29.5 x 30	3110 x 2
2	<b>9755</b>	Corner Table	27.25 x 27.25 x 16.5	589 x 2

**SAMPLE LAYOUT TOTAL IN STANDARD BLACK FRAME 7398**  
**SAMPLE LAYOUT TOTAL IN OPTIONAL FRAME FINISHES 8340**

**Layout L**

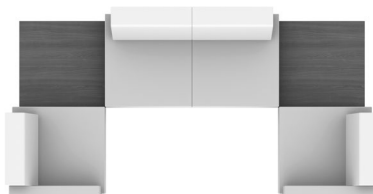

Qty	Model Number	Description	Dimensions	List Price
1	<b>9752NA</b>	Two Seat Sofa - Armless	54 x 29.5 x 30	2219
1	<b>9751L</b>	Lounge Chair - Left Arm	28.5 x 29.5 x 30	1481
1	<b>9751R</b>	Lounge Chair - Right Arm	28.5 x 29.5 x 30	1481
2	<b>9755</b>	Corner Table	27.25 x 27.25 x 16.5	589 x 2

**SAMPLE LAYOUT TOTAL IN STANDARD BLACK FRAME 6359**  
**SAMPLE LAYOUT TOTAL IN OPTIONAL FRAME FINISHES 7361**

**Layout M**

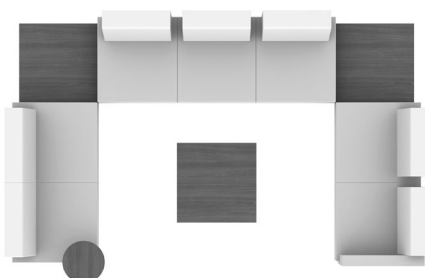

Qty	Model Number	Description	Dimensions	List Price
1	<b>9753NA-OB</b>	Three Seat Sofa Open Back - Armless	80.5 x 29.5 x 30	3110
1	<b>9752L-OB</b>	Two Seat Sofa Open Back - Left Arm	55 x 29.5 x 30	2415
1	<b>9752NA</b>	Two Seat Sofa - Armless	54 x 29.5 x 30	2219
2	<b>9755</b>	Corner Table	27.25 x 27.25 x 16.5	589 x 2
1	<b>9754</b>	Storage Table	27.25 x 27.25 x 16.5	936
1	<b>9758R</b>	Right Tablet	14 x 14 x 17.25	453

**SAMPLE LAYOUT TOTAL IN STANDARD BLACK FRAME 10311**  
**SAMPLE LAYOUT TOTAL IN OPTIONAL FRAME FINISHES 11753**

SAMPLE LAYOUTS

Layout N

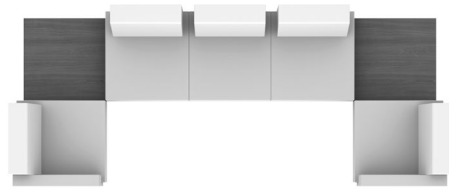

Qty	Model Number	Description	Dimensions	List Price
1	9753NA-OB	Three Seat Sofa Open Back - Armless	80.5 x 29.5 x 30	3110
1	9751L	Lounge Chair - Left Arm	28.5 x 29.5 x 30	1481
1	9751R	Lounge Chair - Right Arm	28.5 x 29.5 x 30	1481
2	9755	Corner Table	27.25 x 27.25 x 16.5	589 x 2

**SAMPLE LAYOUT TOTAL IN STANDARD BLACK FRAME 7250**  
**SAMPLE LAYOUT TOTAL IN OPTIONAL FRAME FINISHES 8252**

Layout O

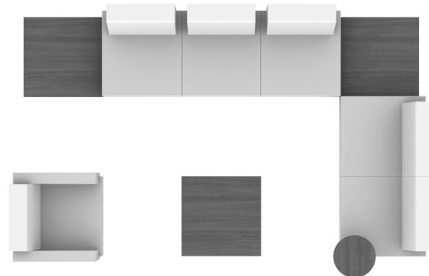

Qty	Model Number	Description	Dimensions	List Price
1	9753NA-OB	Three Seat Sofa Open Back - Armless	80.5 x 29.5 x 30	3110
1	9752NA	Two Seat Sofa - Armless	54 x 29.5 x 30	2219
1	9751	Lounge Chair	29.5 x 29.5 x 30	1733
1	9754	Storage Table	27.25 x 27.25 x 16.5	936
2	9755	Corner Table	27.25 x 27.25 x 16.5	589 x 2
1	9757L	Left Tablet	14 x 14 x 17.25	453

**SAMPLE LAYOUT TOTAL IN STANDARD BLACK FRAME 9629**  
**SAMPLE LAYOUT TOTAL IN OPTIONAL FRAME FINISHES 11013**

Layout P



Qty	Model Number	Description	Dimensions	List Price
1	9753NA-OB	Three Seat Sofa Open Back - Armless	80.5 x 29.5 x 30	3110
1	9752L-OB	Two Seat Sofa Open Back - Left Arm	55 x 29.5 x 30	2415
2	9754	Storage Table	27.25 x 27.25 x 16.5	936 x 2
1	9755	Corner Table	27.25 x 27.25 x 16.5	589
1	9758R	Right Tablet	14 x 14 x 17.25	453

**SAMPLE LAYOUT TOTAL IN STANDARD BLACK FRAME 8439**  
**SAMPLE LAYOUT TOTAL IN OPTIONAL FRAME FINISHES 9704**



**Lounge Chair**  
 COM Yardage: 4  
 Freight Class: 250  
 Product Weight (lbs.): 71  
 Cubic Feet Per Carton: 21.50

	1	2	3	4	5	6	7	8	9	10	11	12
9751	1733	1832	1910	2028	2193	2253	2398	2675	2809	3067	3417	3853

OVERALL DIMENSIONS			SEAT DIMENSIONS			BACK DIMENSIONS	
W	D	H	W	D	H	W	H
30.5	31	30	24	20.5	17.5	22	12.5

RTA 00



9751R



9751L

**Lounge Chair - One Arm**  
 COM Yardage: 3.25  
 Freight Class: 250  
 Product Weight (lbs.): 61  
 Cubic Feet Per Carton: 20

Ganging clip required for sectional use

	1	2	3	4	5	6	7	8	9	10	11	12
9751R	1481	1556	1613	1702	1827	1871	1980	2188	2288	2482	3071	3398
9751L												



OVERALL DIMENSIONS			SEAT DIMENSIONS			BACK DIMENSIONS	
W	D	H	W	D	H	W	H
28.5	31	30	24	20.5	17.5	22	12.5

RTA 00

DESCRIPTION	FEATURES	MODEL#	STANDARD TEXTILE GRADES												
			1	2	3	4	5	6	7	8	9	10	11	12	
 <p><b>Lounge Chair - Armless</b>                      COM Yardage: 2.25                      Freight Class: 250                      Product Weight (lbs.): 51                      Cubic Feet Per Carton: 18.75</p>	Ganging clip required for sectional use	<b>9751NA</b>	1228	1278	1317	1376	1459	1488	1561	1700	1767	1896	2070	2288	
		<b>OVERALL DIMENSIONS</b>			<b>SEAT DIMENSIONS</b>			<b>BACK DIMENSIONS</b>							
		<b>W</b>	<b>D</b>	<b>H</b>	<b>W</b>	<b>D</b>	<b>H</b>	<b>W</b>	<b>H</b>						
		26.5	31	30	24	20.5	17.5	22	12.5						
			<b>RTA 00</b>												

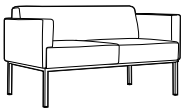

		MODEL#	STANDARD TEXTILE GRADES												
			1	2	3	4	5	6	7	8	9	10	11	12	
 <p><b>Corner Unit</b>                      COM Yardage: 3                      Freight Class: 250                      Product Weight (lbs.): 72                      Cubic Feet Per Carton: 18.50</p>	Ganging clip required for sectional use	<b>9764</b>	1593	1679	1746	1849	1995	2047	2175	2417	2534	2759	3066	3448	
		<b>OVERALL DIMENSIONS</b>			<b>SEAT DIMENSIONS</b>			<b>BACK DIMENSIONS</b>							
		<b>W</b>	<b>D</b>	<b>H</b>	<b>W</b>	<b>D</b>	<b>H</b>	<b>W</b>	<b>H</b>						
		28.5	28.5	30	22	20.5	17.5	22	12.5						
			<b>RTA 00</b>												

		MODEL#	STANDARD TEXTILE GRADES												
			1	2	3	4	5	6	7	8	9	10	11	12	
 <p><b>Two Seat Sofa</b>                      COM Yardage: 6.25                      Freight Class: 250                      Product Weight (lbs.): 111                      Cubic Feet Per Carton: 37.50</p>		<b>9752</b>	2728	2877	2994	3170	3418	3508	3726	4142	4342	4728	5253	5909	
		<b>OVERALL DIMENSIONS</b>			<b>SEAT DIMENSIONS</b>			<b>BACK DIMENSIONS</b>							
		<b>W</b>	<b>D</b>	<b>H</b>	<b>W</b>	<b>D</b>	<b>H</b>	<b>W</b>	<b>H</b>						
		56	31	30	48	20.5	17.5	44	12.5						
			<b>RTA 00</b>												

		MODEL#	STANDARD TEXTILE GRADES												
			1	2	3	4	5	6	7	8	9	10	11	12	
  <p><b>Two Seat Sofa - One Arm</b>                      COM Yardage: 5                      Freight Class: 250                      Product Weight (lbs.): 101                      Cubic Feet Per Carton: 36.25</p>	Ganging clip required for sectional use	<b>9752R</b>	2442	2564	2663	2809	3016	3090	3273	3619	3787	4108	4546	5091	
		<b>9752L</b>													
		<b>OVERALL DIMENSIONS</b>			<b>SEAT DIMENSIONS</b>			<b>BACK DIMENSIONS</b>							
		<b>W</b>	<b>D</b>	<b>H</b>	<b>W</b>	<b>D</b>	<b>H</b>	<b>W</b>	<b>H</b>						
			54	31	30	48	20.5	17.5	44	12.5					
			<b>RTA 00</b>												

		MODEL#	STANDARD TEXTILE GRADES												
			1	2	3	4	5	6	7	8	9	10	11	12	
 <p><b>Two Seat Sofa - Armless</b>                      COM Yardage: 4                      Freight Class: 250                      Product Weight (lbs.): 91                      Cubic Feet Per Carton: 35.50</p>	Ganging clip required for sectional use	<b>9752NA</b>	2219	2319	2397	2515	2681	2740	2886	3163	3296	3554	3904	4340	
		<b>OVERALL DIMENSIONS</b>			<b>SEAT DIMENSIONS</b>			<b>BACK DIMENSIONS</b>							
		<b>W</b>	<b>D</b>	<b>H</b>	<b>W</b>	<b>D</b>	<b>H</b>	<b>W</b>	<b>H</b>						
		52	31	30	48	20.5	17.5	44	12.5						
			<b>RTA 00</b>												

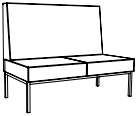
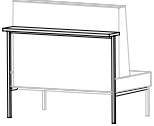
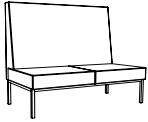

DESCRIPTION	FEATURES	MODEL#	STANDARD TEXTILE GRADES											
			1	2	3	4	5	6	7	8	9	10	11	12
 <p><b>Two Seat Sofa - 42" High Back</b> COM Yardage: 6 Freight Class: 250 Product Weight (lbs.): 120 Cubic Feet Per Carton: 48.50</p>	Ganging clip required for sectional use	<b>9752NAHB42</b>	2013	2216	2378	2620	2963	3125	3437	3933	4316	4741	5617	6550
			<b>OVERALL DIMENSIONS</b>			<b>SEAT DIMENSIONS</b>			<b>BACK DIMENSIONS</b>					
			<b>W</b>	<b>D</b>	<b>H</b>	<b>W</b>	<b>D</b>	<b>H</b>	<b>W</b>	<b>H</b>				
			52	31	42	48	20.5	17.5	44	24.5				
			<b>RTA 00</b>											
 <p><b>Two Seat Sofa - 42" High Back w/36" H Table Shelf</b> COM Yardage: 8 Freight Class: 250 Product Weight (lbs.): 135 Cubic Feet Per Carton: 63.75</p>	Ganging clip required for sectional use	<b>9752NAHB42TB</b>	2832	2984	3104	3284	3539	3659	3890	4258	4543	4858	5508	6201
			<b>OVERALL DIMENSIONS</b>			<b>SEAT DIMENSIONS</b>			<b>BACK DIMENSIONS</b>					
			<b>W</b>	<b>D</b>	<b>H</b>	<b>W</b>	<b>D</b>	<b>H</b>	<b>W</b>	<b>H</b>				
			52	41	42	48	20.5	17.5	44	24.5				
			<b>RTA 00</b>											
 <p><b>Two Seat Sofa - 48" High Back</b> COM Yardage: 6 Freight Class: 250 Product Weight (lbs.): 130 Cubic Feet Per Carton: 55</p>	Ganging clip required for sectional use	<b>9752NAHB48</b>	2082	2304	2481	2746	3121	3298	3639	4182	4601	5065	6023	7044
			<b>OVERALL DIMENSIONS</b>			<b>SEAT DIMENSIONS</b>			<b>BACK DIMENSIONS</b>					
			<b>W</b>	<b>D</b>	<b>H</b>	<b>W</b>	<b>D</b>	<b>H</b>	<b>W</b>	<b>H</b>				
			52	31	48	48	20.5	17.5	44	30.5				
			<b>RTA 00</b>											
 <p><b>Two Seat Sofa - 48" High Back w/42" H Table Shelf</b> COM Yardage: 8.75 Freight Class: 250 Product Weight (lbs.): 145 Cubic Feet Per Carton: 71.25</p>	Ganging clip required for sectional use	<b>9752NAHB48TB</b>	2901	3052	3172	3352	3607	3727	3958	4326	4610	4926	5575	6268
			<b>OVERALL DIMENSIONS</b>			<b>SEAT DIMENSIONS</b>			<b>BACK DIMENSIONS</b>					
			<b>W</b>	<b>D</b>	<b>H</b>	<b>W</b>	<b>D</b>	<b>H</b>	<b>W</b>	<b>H</b>				
			52	41	48	48	20.5	17.5	44	30.5				
			<b>RTA 00</b>											
 <p><b>Two Seat Sofa - Open Back</b> COM Yardage: 6.25 Freight Class: 250 Product Weight (lbs.): 111 Cubic Feet Per Carton: 35.25</p>		<b>9752-OB</b>	2698	2845	2962	3138	3387	3476	3694	4110	4310	4697	5222	5877
			<b>OVERALL DIMENSIONS</b>			<b>SEAT DIMENSIONS</b>			<b>BACK DIMENSIONS</b>					
			<b>W</b>	<b>D</b>	<b>H</b>	<b>W</b>	<b>D</b>	<b>H</b>	<b>W</b>	<b>H</b>				
			56	29.5	30	54	20.5	17.5	48	12.5				
			<b>RTA 00</b>											



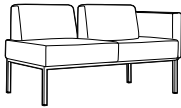

DESCRIPTION	FEATURES	MODEL#	STANDARD TEXTILE GRADES											
			1	2	3	4	5	6	7	8	9	10	11	12
 <b>9752R-OB</b>	 <b>9752L-OB</b>	<b>9752R-OB</b> <b>9752L-OB</b>	2415	2537	2635	2781	2990	3064	3246	3593	3759	4081	4519	4081
			<b>OVERALL DIMENSIONS</b> <b>W D H</b>			<b>SEAT DIMENSIONS</b> <b>W D H</b>			<b>BACK DIMENSIONS</b> <b>W H</b>					
<b>Two Seat Sofa - Open Back - One Arm</b> COM Yardage: 5.25 Freight Class: 250 Product Weight (lbs.): 101 Cubic Feet Per Carton: 36.25	Ganging clip required for sectional use		54	31	30	48	20.5	17.5	44	12.5				
			<b>RTA 00</b>											

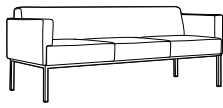

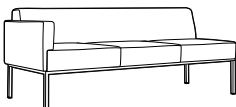
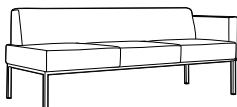
DESCRIPTION	FEATURES	MODEL#	STANDARD TEXTILE GRADES											
			1	2	3	4	5	6	7	8	9	10	11	12
 <b>9752NA-OB</b>		<b>9752NA-OB</b>	2189	2288	2367	2484	2650	2709	2855	3133	3266	3523	3873	4309
			<b>OVERALL DIMENSIONS</b> <b>W D H</b>			<b>SEAT DIMENSIONS</b> <b>W D H</b>			<b>BACK DIMENSIONS</b> <b>W H</b>					
<b>Two Seat Sofa - Open Back - Armless</b> COM Yardage: 4.25 Freight Class: 250 Product Weight (lbs.): 91 Cubic Feet Per Carton: 35.50			52	31	30	48	20.5	17.5	44	12.5				
			<b>RTA 00</b>											

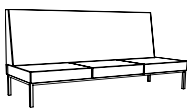

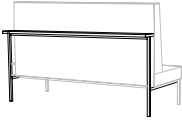
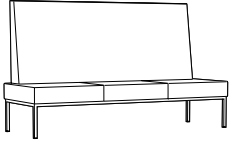

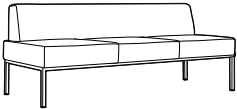
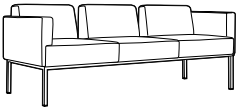
DESCRIPTION	FEATURES	MODEL#	STANDARD TEXTILE GRADES											
			1	2	3	4	5	6	7	8	9	10	11	12
 <b>9753</b>		<b>9753</b>	3650	3845	4002	4237	4570	4688	4978	5535	5800	6316	7016	7888
			<b>OVERALL DIMENSIONS</b> <b>W D H</b>			<b>SEAT DIMENSIONS</b> <b>W D H</b>			<b>BACK DIMENSIONS</b> <b>W H</b>					
<b>Three Seat Sofa</b> COM Yardage: 9.50 Freight Class: 250 Product Weight (lbs.): 153 Cubic Feet Per Carton: 54.50			82.5	31	30.	76.5	20.5	17.5	66	12.5				
			<b>RTA 00</b>											

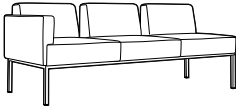
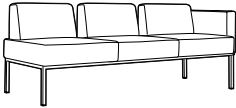
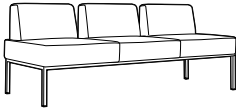
DESCRIPTION	FEATURES	MODEL#	STANDARD TEXTILE GRADES											
			1	2	3	4	5	6	7	8	9	10	11	12
 <b>9753R</b>	 <b>9753L</b>	<b>9753R</b> <b>9753L</b>	3411	3583	3721	3926	4216	4320	4575	5061	5294	5745	6358	7121
			<b>OVERALL DIMENSIONS</b> <b>W D H</b>			<b>SEAT DIMENSIONS</b> <b>W D H</b>			<b>BACK DIMENSIONS</b> <b>W H</b>					
<b>Three Seat Sofa - One Arm</b> COM Yardage: 8.25 Freight Class: 250 Product Weight (lbs.): 143 Cubic Feet Per Carton: 54.50	Ganging clip required for sectional use		81.5	31	30	80.5	20.5	17.5	74	12.5				
			<b>RTA 00</b>											

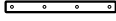
DESCRIPTION	FEATURES	MODEL#	STANDARD TEXTILE GRADES											
			1	2	3	4	5	6	7	8	9	10	11	12
 <b>9753NAHB42</b>		<b>9753NAHB42</b>	3033	3256	3435	3703	4083	4262	4607	5156	5578	6049	7017	8049
			<b>OVERALL DIMENSIONS</b> <b>W D H</b>			<b>SEAT DIMENSIONS</b> <b>W D H</b>			<b>BACK DIMENSIONS</b> <b>W H</b>					
<b>Three Seat Sofa - 42" High Back</b> COM Yardage: 12.25 Freight Class: 300 Product Weight (lbs.): 143 Cubic Feet Per Carton: 72.50	Ganging clip required for sectional use		80.5	31	42	74	20.5	17.5	74	24.5				
			<b>RTA 00</b>											

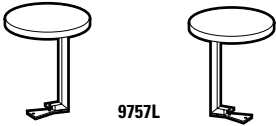
DESCRIPTION	FEATURES	MODEL#	STANDARD TEXTILE GRADES												
			1	2	3	4	5	6	7	8	9	10	11	12	
 <p><b>Three Seat Sofa - 42" High Back w/36" H Table Shelf</b>                      COM Yardage: 9                      Freight Class: 300                      Product Weight (lbs.): 158                      Cubic Feet Per Carton: 93.50</p>	Ganging clip required for sectional use	<b>9753NAHB42TB</b>	3989	4186	4343	4579	4914	5071	5374	5858	6231	6645	7498	8408	
		<b>OVERALL DIMENSIONS</b>			<b>SEAT DIMENSIONS</b>			<b>BACK DIMENSIONS</b>							
		<b>W</b>	<b>D</b>	<b>H</b>	<b>W</b>	<b>D</b>	<b>H</b>	<b>W</b>	<b>H</b>						
			80.5	41	42	80.5	20.5	17.5	74	24.5					
			<b>RTA 00</b>												
 <p><b>Three Seat Sofa - 48" High Back</b>                      COM Yardage: 13.25                      Freight Class: 250                      Product Weight (lbs.): 168                      Cubic Feet Per Carton: 82.25</p>	Ganging clip required for sectional use	<b>9753NAHB48</b>	3227	3451	3629	3898	4278	4455	4800	5349	5773	6243	7212	8243	
		<b>OVERALL DIMENSIONS</b>			<b>SEAT DIMENSIONS</b>			<b>BACK DIMENSIONS</b>							
		<b>W</b>	<b>D</b>	<b>H</b>	<b>W</b>	<b>D</b>	<b>H</b>	<b>W</b>	<b>H</b>						
			80.5	31	48	80.5	20.5	17.5	74	30.5					
			<b>RTA 00</b>												
 <p><b>Three Seat Sofa - 48" High Back w/42" H Table Shelf</b>                      COM Yardage: 9                      Freight Class: 300                      Product Weight (lbs.): 158                      Cubic Feet Per Carton: 106</p>	Ganging clip required for sectional use	<b>9753NAHB48TB</b>	4183	4446	4624	4892	5273	5452	5796	6345	6769	7239	8208	9241	
		<b>OVERALL DIMENSIONS</b>			<b>SEAT DIMENSIONS</b>			<b>BACK DIMENSIONS</b>							
		<b>W</b>	<b>D</b>	<b>H</b>	<b>W</b>	<b>D</b>	<b>H</b>	<b>W</b>	<b>H</b>						
			80.5	41	48	80.5	20.5	17.5	74	30.5					
			<b>RTA 00</b>												
 <p><b>Three Seat Sofa - Armless</b>                      COM Yardage: 7                      Freight Class: 250                      Product Weight (lbs.): 133                      Cubic Feet Per Carton: 51.50</p>	Ganging clip required for sectional use	<b>9753NA</b>	3141	3289	3407	3583	3832	3922	4139	4555	4756	5142	5667	6322	
		<b>OVERALL DIMENSIONS</b>			<b>SEAT DIMENSIONS</b>			<b>BACK DIMENSIONS</b>							
		<b>W</b>	<b>D</b>	<b>H</b>	<b>W</b>	<b>D</b>	<b>H</b>	<b>W</b>	<b>H</b>						
			80.5	31	30	80.5	20.5	17.5	74	12.5					
			<b>RTA 00</b>												
 <p><b>Three Seat Sofa - Open Back</b>                      COM Yardage: 8                      Freight Class: 250                      Product Weight (lbs.): 153                      Cubic Feet Per Carton: 54.50</p>		<b>9753-OB</b>	3624	3819	3976	4211	4543	4662	4953	5507	5775	6290	6990	7861	
		<b>OVERALL DIMENSIONS</b>			<b>SEAT DIMENSIONS</b>			<b>BACK DIMENSIONS</b>							
		<b>W</b>	<b>D</b>	<b>H</b>	<b>W</b>	<b>D</b>	<b>H</b>	<b>W</b>	<b>H</b>						
			82.5	31	30	80.5	20.5	17.5	74	12.5					
			<b>RTA 00</b>												

DESCRIPTION	FEATURES	MODEL#	STANDARD TEXTILE GRADES											
			1	2	3	4	5	6	7	8	9	10	11	12
 <p><b>9753R-OB</b></p>	 <p><b>9753L-OB</b></p>	<p><b>9753R-OB</b> <b>9753L-OB</b></p>	3380	3552	3688	3894	4184	4288	4543	5029	5263	5713	6325	7089
			<p><b>OVERALL DIMENSIONS</b></p> <p><b>W D H</b></p>			<p><b>SEAT DIMENSIONS</b></p> <p><b>W D H</b></p>			<p><b>BACK DIMENSIONS</b></p> <p><b>W H</b></p>					
<p><b>Three Seat Sofa - Open Back - One Arm</b> COM Yardage: 7 Freight Class: 250 Product Weight (lbs.): 143 Cubic Feet Per Carton: 54.50</p>	Ganging clip required for sectional use		81.5	31	30	80.5	20.5	17.5	74	12.5				
			<b>RTA 00</b>											
		<p><b>9753NA-OB</b></p>	3110	3259	3376	3552	3800	3890	4108	4524	4725	5110	5636	6291
			<p><b>OVERALL DIMENSIONS</b></p> <p><b>W D H</b></p>			<p><b>SEAT DIMENSIONS</b></p> <p><b>W D H</b></p>			<p><b>BACK DIMENSIONS</b></p> <p><b>W H</b></p>					
<p><b>Three Seat Sofa - Open Back - Armless</b> COM Yardage: 6.25 Freight Class: 250 Product Weight (lbs.): 133 Cubic Feet Per Carton: 51.50</p>	Ganging clip required for sectional use		80.5	31	30	80.5	20.5	17.5	74	12.5				
			<b>RTA 00</b>											
		<p><b>9754</b></p>	936	-	-	-	-	-	-	-	-	-	-	-
			<p><b>OVERALL DIMENSIONS</b></p> <p><b>W D H</b></p>			<p><b>SEAT DIMENSIONS</b></p> <p><b>W D H</b></p>			<p><b>BACK DIMENSIONS</b></p> <p><b>W H</b></p>					
<p><b>Storage Table</b> COM Yardage: N/A Freight Class: 125 Product Weight (lbs.): 65 Cubic Feet Per Carton: 11.50</p>	Ganging clip required for sectional use		27.25	27.25	16.5	-	-	-	-	-				
			<b>RTA 00</b>											
		<p><b>9755</b></p>	589	-	-	-	-	-	-	-	-	-	-	-
			<p><b>OVERALL DIMENSIONS</b></p> <p><b>W D H</b></p>			<p><b>SEAT DIMENSIONS</b></p> <p><b>W D H</b></p>			<p><b>BACK DIMENSIONS</b></p> <p><b>W H</b></p>					
<p><b>Corner Table</b> COM Yardage: N/A Freight Class: 150 Product Weight (lbs.): 40 Cubic Feet Per Carton: 8</p>	Ganging clip required for sectional use		27.25	27.25	12.5	-	-	-	-	-				
			<b>RTA 00</b>											
		<p><b>9759</b></p>	16	-	-	-	-	-	-	-	-	-	-	-
			<p><b>OVERALL DIMENSIONS</b></p> <p><b>W D H</b></p>			<p><b>SEAT DIMENSIONS</b></p> <p><b>W D H</b></p>			<p><b>BACK DIMENSIONS</b></p> <p><b>W H</b></p>					
<p><b>Ganging Bracket</b> COM Yardage: N/A Freight Class: 70 Product Weight (lbs.): .52 Cubic Feet Per Carton: .01</p>	Only one set is needed per connection.		1.	.75	10.	-	-	-	-	-				
			<b>RTA 00</b>											

DESCRIPTION	FEATURES	MODEL#	STANDARD TEXTILE GRADES												
			1	2	3	4	5	6	7	8	9	10	11	12	
 <p><b>Tablet</b> COM Yardage: N/A Freight Class: 150 Product Weight (lbs.): 12 Cubic Feet Per Carton: 2.50</p>	Mounts underneath of seating.	9757L	453	-	-	-	-	-	-	-	-	-	-	-	-
		9758R	-	-	-	-	-	-	-	-	-	-	-	-	-
		<b>OVERALL DIMENSIONS</b>			<b>SEAT DIMENSIONS</b>			<b>BACK DIMENSIONS</b>							
		W	D	H	W	D	H	W	H						
			14	17.25	14	-	-	-	-	-	-	-	-	-	-
			RTA 1			ups									
 <p><b>Power Module</b> COM Yardage: N/A Freight Class: 60 Product Weight (lbs.): 3 Cubic Feet Per Carton: .01</p>	Mounts underneath of seating or tables.	9760	345	-	-	-	-	-	-	-	-	-	-	-	-
		10 Ft. power cord													
		<b>OVERALL DIMENSIONS</b>			<b>SEAT DIMENSIONS</b>			<b>BACK DIMENSIONS</b>							
		W	D	H	W	D	H	W	H						
			6	2.5	2.75	-	-	-	-	-	-	-	-	-	-
			RTA 00			ups									
 <p><b>One Seat Bench</b> COM Yardage: 2 Freight Class: 250 Product Weight (lbs.): 37 Cubic Feet Per Carton: 10.75</p>	Ganging clip required for sectional use	9761	919	944	964	993	1035	1049	1086	1155	1189	1253	1341	1450	
		<b>OVERALL DIMENSIONS</b>			<b>SEAT DIMENSIONS</b>			<b>BACK DIMENSIONS</b>							
		W	D	H	W	D	H	W	H						
					27.5	28.5	17.5	-	-	-	-	-	-	-	-
			RTA 00												
 <p><b>Two Seat Bench</b> COM Yardage: 4 Freight Class: 250 Product Weight (lbs.): 57 Cubic Feet Per Carton: 21.25</p>	Ganging clip required for sectional use	9762	1636	1686	1725	1783	1867	1897	1970	2108	2175	2304	2479	2697	
		<b>OVERALL DIMENSIONS</b>			<b>SEAT DIMENSIONS</b>			<b>BACK DIMENSIONS</b>							
		W	D	H	W	D	H	W	H						
					54	28.5	17.5	-	-	-	-	-	-	-	-
			RTA 00												
 <p><b>Three Seat Bench</b> COM Yardage: 6 Freight Class: 250 Product Weight (lbs.): 80 Cubic Feet Per Carton: 29.50</p>	Ganging clip required for sectional use	9763	2315	2390	2448	2536	2661	2705	2814	3024	3122	3316	3578	3905	
		<b>OVERALL DIMENSIONS</b>			<b>SEAT DIMENSIONS</b>			<b>BACK DIMENSIONS</b>							
		W	D	H	W	D	H	W	H						
					80.5	28.5	17.5	-	-	-	-	-	-	-	-
			RTA 00												

DESCRIPTION	FEATURES	MODEL#	STANDARD TEXTILE GRADES											
			1	2	3	4	5	6	7	8	9	10	11	12

			1	2	3	4	5	6	7	8	9	10	11	12
		<b>9765</b>	1707	-	-	-	-	-	-	-	-	-	-	-



**Coffee Storage Table (2 Seat Length)**  
COM Yardage: N/A  
Freight Class: 150  
Product Weight (lbs.): 112  
Cubic Feet Per Carton: 20.50

Ganging clip required for sectional use

**RTA 00**

OVERALL DIMENSIONS			SEAT DIMENSIONS			BACK DIMENSIONS	
W	D	H	W	D	H	W	H
53.75	27.25	16.5	-	-	-	-	-

			1	2	3	4	5	6	7	8	9	10	11	12
		<b>9766</b>	1103	-	-	-	-	-	-	-	-	-	-	-



**Coffee Table (2 Seat Length)**  
COM Yardage: N/A  
Freight Class: 150  
Product Weight (lbs.): 68  
Cubic Feet Per Carton: 17.75

**RTA 00**

OVERALL DIMENSIONS			SEAT DIMENSIONS			BACK DIMENSIONS	
W	D	H	W	D	H	W	H
54	27.5	13	-	-	-	-	-

			1	2	3	4	5	6	7	8	9	10	11	12
		<b>9769S24</b>	601	615	626	640	661	661	689	719	742	769	821	878

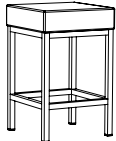

**24" Stool**  
COM Yardage: .50  
Freight Class: 250  
Product Weight (lbs.): 22  
Cubic Feet Per Carton: 6

**RTA 00**

OVERALL DIMENSIONS			SEAT DIMENSIONS			BACK DIMENSIONS	
W	D	H	W	D	H	W	H
15	15	24	15	15	3	-	-

			1	2	3	4	5	6	7	8	9	10	11	12
		<b>9769S30</b>	656	669	679	694	714	724	742	772	795	819	871	926

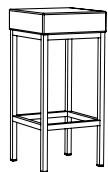

**30" Stool**  
COM Yardage: .50  
Freight Class: 150  
Product Weight (lbs.): 23  
Cubic Feet Per Carton: 5.5

**RTA 00**

OVERALL DIMENSIONS			SEAT DIMENSIONS			BACK DIMENSIONS	
W	D	H	W	D	H	W	H
15	15	30	15	15	30	-	-

BRADEN™



model 7871

model 7870R, 7870, 7870L

STANDARD FEATURES

- A flexible modular seating system that is exceptionally durable. Combine these seating components into a configuration that suits your space.
- Braden uses a unique ganging feature which locks units solidly together, but allows them to be separated and reconfigured when necessary. Locking "Pins" will always be on the left side of a ganging unit, while the pin receptacle will always be on the right side, seated.

right side seated only. Add "GL" for Left side seated only. Add "GC" for corner units only, both sides.

- For highly resilient, high density Ultracell foam on seat, Please specify (UC) after the model number. Add \$52 for the seat. Add \$103 for the seat and back.
- Optional Non-slip glide for hard surface flooring. Please specify (NSG). Add \$24.
- Braden can be upholstered in Fabric, Vinyl, Leather or Leather/Mock Leather.
- Model 7874 Table (top) is offered in the all the standard laminates. Please Specify.
- Not available in Crescent fabric

OPTIONAL FEATURES

- For ganging hardware please use the following codes: Add "GB" for both sides. Add "GR" for

DESCRIPTION	FEATURES	MODEL#	STANDARD TEXTILE GRADES											
-------------	----------	--------	-------------------------	--	--	--	--	--	--	--	--	--	--	--

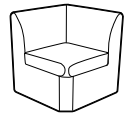

**Corner Unit**  
COM Yardage: 4  
Freight Class:  
Product Weight (lbs.): 50  
Cubic Feet Per Carton: 16.5

	1	2	3	4	5	6	7	8	9	10	11	12
<b>7867</b>	912	1023	1113	1246	1434	1523	1695	1968	2177	2412	2893	3407

OVERALL DIMENSIONS			SEAT DIMENSIONS			BACK DIMENSIONS	
W	D	H	W	D	H	W	H

28	28	30	20	17	20.5	19.5	12.5
----	----	----	----	----	------	------	------

RTA 00



**Single Seater**  
COM Yardage: 1.75  
Freight Class:  
Product Weight (lbs.): 26  
Cubic Feet Per Carton: 2.9

	1	2	3	4	5	6	7	8	9	10	11	12
<b>7868</b>	245	294	333	391	473	512	588	706	799	901	1112	1336

OVERALL DIMENSIONS			SEAT DIMENSIONS			BACK DIMENSIONS	
W	D	H	W	D	H	W	H

3.75	25	25					
------	----	----	--	--	--	--	--

RTA 00



**Single Seater**  
COM Yardage: 2.75  
Freight Class: 250  
Product Weight (lbs.): 38  
Cubic Feet Per Carton: 16.50

	1	2	3	4	5	6	7	8	9	10	11	12
<b>7870</b>	566	645	708	804	937	986	1103	1327	1434	1643	1926	2279

OVERALL DIMENSIONS			SEAT DIMENSIONS			BACK DIMENSIONS	
W	D	H	W	D	H	W	H

24	27.5	30	24	19.5	16.5	24	13.5
----	------	----	----	------	------	----	------

RTA 00



**Single Seater - Left Arm**  
COM Yardage: 3.75  
Freight Class: 250  
Product Weight (lbs.): 45  
Cubic Feet Per Carton: 16.50

	1	2	3	4	5	6	7	8	9	10	11	12
<b>7870L</b>	645	753	840	970	1152	1217	1378	1684	1831	2115	2500	2980

OVERALL DIMENSIONS			SEAT DIMENSIONS			BACK DIMENSIONS	
W	D	H	W	D	H	W	H

27	27.5	30	24	19.5	16.5	24	13.5
----	------	----	----	------	------	----	------

RTA 00

DESCRIPTION	FEATURES	MODEL#	STANDARD TEXTILE GRADES											
			1	2	3	4	5	6	7	8	9	10	11	12

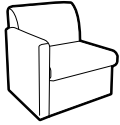

**Single Seater - Right Arm**  
 COM Yardage: 3.75  
 Freight Class: 250  
 Product Weight (lbs.): 45  
 Cubic Feet Per Carton: 16.50

<b>7870R</b>	645	753	840	970	1152	1217	1378	1684	1831	2115	2500	2980
--------------	-----	-----	-----	-----	------	------	------	------	------	------	------	------

OVERALL DIMENSIONS			SEAT DIMENSIONS			BACK DIMENSIONS	
W	D	H	W	D	H	W	H
27	27.5	30	24	19.5	16.5	24	13.5

**RTA 00**



**Single Seater - with Arms**  
 COM Yardage: 4.75  
 Freight Class: 250  
 Product Weight (lbs.): 52  
 Cubic Feet Per Carton: 16.50

<b>7871</b>	797	921	1022	1172	1382	1459	1644	2001	2172	2500	2948	3506
-------------	-----	-----	------	------	------	------	------	------	------	------	------	------

OVERALL DIMENSIONS			SEAT DIMENSIONS			BACK DIMENSIONS	
W	D	H	W	D	H	W	H
30	27.5	30	24	19.5	16.5	24	13.5

**RTA 00**



**Corner Unit**  
 COM Yardage: 2.75  
 Freight Class: 300  
 Product Weight (lbs.): 31  
 Cubic Feet Per Carton: 16.50

<b>7872</b>	522	601	665	760	894	942	1059	1284	1391	1599	1882	2235
-------------	-----	-----	-----	-----	-----	-----	------	------	------	------	------	------

OVERALL DIMENSIONS			SEAT DIMENSIONS			BACK DIMENSIONS	
W	D	H	W	D	H	W	H
24	27.5	30	20	19.5	16.5	15	13.5

**RTA 00**

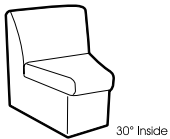

**Corner Unit**  
 COM Yardage: 2.75  
 Freight Class: 300  
 Product Weight (lbs.): 31  
 Cubic Feet Per Carton: 16.50

<b>7873</b>	522	601	665	760	894	942	1059	1284	1391	1599	1882	2235
-------------	-----	-----	-----	-----	-----	-----	------	------	------	------	------	------

OVERALL DIMENSIONS			SEAT DIMENSIONS			BACK DIMENSIONS	
W	D	H	W	D	H	W	H
24	27.5	30	16	19.5	16.5	21.5	13.5

**RTA 00**



**Table - 24" Square w/Upholstered Sides**  
 COM Yardage: 1.75  
 Freight Class: 125  
 Product Weight (lbs.): 38  
 Cubic Feet Per Carton: 6.25

<b>7874</b>	427	478	518	578	664	695	769	912	980	1113	1292	1518
-------------	-----	-----	-----	-----	-----	-----	-----	-----	-----	------	------	------

OVERALL DIMENSIONS			SEAT DIMENSIONS			BACK DIMENSIONS	
W	D	H	W	D	H	W	H
24	24	14.5	-	-	-	-	-

**RTA 00**

DESCRIPTION	FEATURES	MODEL#	STANDARD TEXTILE GRADES											
-------------	----------	--------	-------------------------	--	--	--	--	--	--	--	--	--	--	--

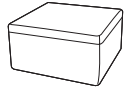

**Foot Stool/Single Bench - 24" Square**  
 COM Yardage: 2.25  
 Freight Class: 150  
 Product Weight (lbs.): 44  
 Cubic Feet Per Carton: 8.50

	1	2	3	4	5	6	7	8	9	10	11	12
<b>7874FS</b>	487	546	595	668	771	807	898	1069	1150	1309	1525	1794

OVERALL DIMENSIONS			SEAT DIMENSIONS			BACK DIMENSIONS	
W	D	H	W	D	H	W	H
24	24	17.5	-	-	-	-	-

RTA 00

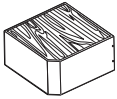

**Corner Table - 17" Square** w/Upholstered Sides  
 COM Yardage: 1.75  
 Freight Class: 125  
 Product Weight (lbs.): 45  
 Cubic Feet Per Carton: 7.50

	1	2	3	4	5	6	7	8	9	10	11	12
<b>7880</b>	582	632	671	730	812	850	925	1045	1138	1240	1450	1674

OVERALL DIMENSIONS			SEAT DIMENSIONS			BACK DIMENSIONS	
W	D	H	W	D	H	W	H
27	27	14.5	-	-	-	-	-

RTA 00



**BRIDGES II COLLABORATIVE SEATING**



model BRTSE2424B



model BRTSE6060B



model BRTST2448F

**STANDARD FEATURES**

- For all Bridges II components, please see the Bridges II section of the Desking Price Book.
- Bridges collaborative seating collection consists of seating, privacy screens, tables, tablets and power.
- It is a versatile modular furniture series which can be configured into many space planning scenarios, including corner, in-line, open concept, traditional reception, as well as secluded seating with high privacy partitions.
- Furniture pieces can be used as stand alone items or can be mechanically linked together to form a variety of seating configurations.
- Seat and backrest can be integrated with Bridges tables.
- Corner tables and in-line 6" table modules double as power delivery centers.
- Dedicated seat backrests feature dual USB charging port.
- Some in line 6" table modules are furnished with grommets to support tablets.
- Legs are available in standard Bridges metal painted finishes and anodized aluminum finish.
- Bridges Collaborative Seating upholstery features a single stitch, thick white thread around the edges. The white, wide stitch along with crisp corners are part of its distinctive personality.
- In order to achieve crisp edges and to minimize "pillow" effect caused by taut fabric, the upholstery material has been applied deliberately loose, which may over time, produce puckering of the upholstery surface material This can be easily corrected by stretching the fabric by hand or during vacuuming.
- Freestanding 17"h table. Central partition divides space under top surface into two 11" deep compartments.

- In order to efficiently utilize fabric yield, all 60" seats and backs feature a seam in the middle. The double stitch seam is sewn with a thin thread, closely matching the upholstery material in color.
- Some complicated fabric patterns prevent pattern matching and will be upholstered without the seam at the discretion of the factory.
- Should you require no middle seam by cutting into the roll, please specify "NO SEAM" at time of your order.

**OPTIONAL FEATURES**

- Upholstery options: fabric, vinyl, leather or leather/mock leather combination. If a two tone fabric or a fabric / leather combination is required please fill in a fabric combination sketch showing which material goes where. Please contact Customer Care.
- Optional Anodized Aluminum Leg on all models. Add \$54.
- Models BRTS2406BT and BRTS2406BPT include 9.5" x 14.5" swivel tablet. If top is specified in high pressure laminate, tablet will also be manufactured in high pressure laminate.
- Bridges II tables and tablets are offered in the following laminate finishes: Absolute Acajou (ACJ), Asian Night (ASN), Avant Cherry (AWC), Avant Honey (AWH), Black (BLK), Brushed Cobalt (BRC), Clear Maple (CMB), Custom Grey (CGY), Dark Espresso (DES), Designer White (DWT), Hayden Grey (HGT), Storm Grey (SOG), Tiger Fruitwood (TFW), Tiger Walnut (TWL), Walnut Heights (WHE), White Chocolate (WHC), Willow Grey (WGY), and Winter Cherry (WCR). Please Specify.

DESCRIPTION	FEATURES	MODEL#	STANDARD TEXTILE GRADES											
-------------	----------	--------	-------------------------	--	--	--	--	--	--	--	--	--	--	--

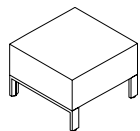

**Lounge Seat - 24"**  
COM Yardage: 1.25  
Freight Class: 150  
Product Weight (lbs.): 22.70  
Cubic Feet Per Carton: 5.57

	1	2	3	4	5	6	7	8	9	10	11	12
--	---	---	---	---	---	---	---	---	---	----	----	----

<b>BRTSE24NB</b>	580	635	635	670	720	743	788	862	918	980	1107	1243
------------------	-----	-----	-----	-----	-----	-----	-----	-----	-----	-----	------	------

OVERALL DIMENSIONS			SEAT DIMENSIONS			BACK DIMENSIONS		
W	D	H	W	D	H	W	H	
24	24	17	-	-	-	-	-	

RTA 00

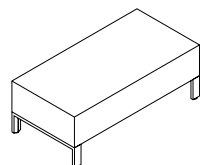

**Lounge Seat - 48"**  
COM Yardage: 2  
Freight Class: 250  
Product Weight (lbs.): 36.90  
Cubic Feet Per Carton: 11.33

	1	2	3	4	5	6	7	8	9	10	11	12
--	---	---	---	---	---	---	---	---	---	----	----	----

<b>BRTSE48NB</b>	1057	1144	1144	1200	1280	1318	1391	1507	1596	1696	1901	2118
------------------	------	------	------	------	------	------	------	------	------	------	------	------

OVERALL DIMENSIONS			SEAT DIMENSIONS			BACK DIMENSIONS		
W	D	H	W	D	H	W	H	
24	48	17	-	-	-	-	-	

RTA 00

# LOUNGE

# BRIDGES II COLLABORATIVE SEATING B

DESCRIPTION	FEATURES	MODEL#	STANDARD TEXTILE GRADES											
-------------	----------	--------	-------------------------	--	--	--	--	--	--	--	--	--	--	--

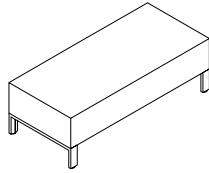

**Lounge Seat - 60"**  
 COM Yardage: 2  
 Freight Class: 250  
 Product Weight (lbs.): 47  
 Cubic Feet Per Carton: 14.17

	1	2	3	4	5	6	7	8	9	10	11	12
<b>BRTSE60NB</b>	1224	1284	1331	1401	1502	1549	1640	1784	1897	2021	2276	2549

OVERALL DIMENSIONS			SEAT DIMENSIONS			BACK DIMENSIONS	
W	D	H	W	D	H	W	H
24	60	17	-	-	-	-	-

RTA 00

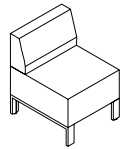

**Lounge Seat, Full Backrest - 24"**  
 COM Yardage: 2.25  
 Freight Class: 250  
 Product Weight (lbs.): 33  
 Cubic Feet Per Carton: 9.57

	1	2	3	4	5	6	7	8	9	10	11	12
<b>BRTSE2424B</b>	914	1011	1011	1075	1164	1207	1289	1419	1520	1632	1862	2107

OVERALL DIMENSIONS			SEAT DIMENSIONS			BACK DIMENSIONS	
W	D	H	W	D	H	W	H
24	24	29	-	-	-	-	-

RTA 00

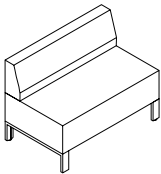

**Lounge Seat, Full Backrest - 48"**  
 COM Yardage: 3.50  
 Freight Class: 250  
 Product Weight (lbs.): 55.50  
 Cubic Feet Per Carton: 19.33

	1	2	3	4	5	6	7	8	9	10	11	12
<b>BRTSE4848B</b>	1688	1837	1837	1936	2077	2142	2270	2472	2629	2802	3161	3542

OVERALL DIMENSIONS			SEAT DIMENSIONS			BACK DIMENSIONS	
W	D	H	W	D	H	W	H
24	48	29	-	-	-	-	-

RTA 00

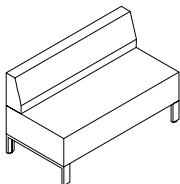

**Lounge Seat, Full Backrest - 60"**  
 COM Yardage: 4.50  
 Freight Class: 250  
 Product Weight (lbs.): 70  
 Cubic Feet Per Carton: 24.17

	1	2	3	4	5	6	7	8	9	10	11	12
<b>BRTSE6060B</b>	1956	2149	2149	2276	2456	2540	2705	2966	3166	3389	3850	4340

OVERALL DIMENSIONS			SEAT DIMENSIONS			BACK DIMENSIONS	
W	D	H	W	D	H	W	H
24	60	29	-	-	-	-	-

RTA 00

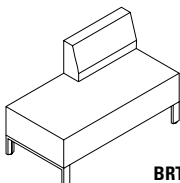

**BRTSE2448BR**

**Lounge Seat, 24" Offset Backrest**  
 COM Yardage: ??  
 Freight Class: 250  
 Product Weight (lbs.): 46.10  
 Cubic Feet Per Carton: 19.33

	1	2	3	4	5	6	7	8	9	10	11	12
<b>BRTSE2448BR</b>	1391	1521	1521	1604	1725	1781	1892	2065	2199	2347	2654	2981

<b>BRTSE2448BL</b>	1391	1521	1521	1604	1725	1781	1892	2065	2199	2347	2654	2981
--------------------	------	------	------	------	------	------	------	------	------	------	------	------

OVERALL DIMENSIONS			SEAT DIMENSIONS			BACK DIMENSIONS	
W	D	H	W	D	H	W	H
24	48	29	-	-	-	-	-

RTA 00

DESCRIPTION	FEATURES	MODEL#	STANDARD TEXTILE GRADES											
-------------	----------	--------	-------------------------	--	--	--	--	--	--	--	--	--	--	--

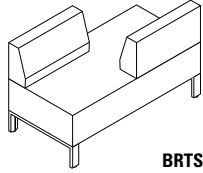

**BRTSE2448BODR**

**Lounge Seat, Two 24" Offset Backrests**  
 COM Yardage: 4  
 Freight Class: 250  
 Product Weight (lbs.): 46.5  
 Cubic Feet Per Carton: 19.33

	1	2	3	4	5	6	7	8	9	10	11	12
<b>BRTSE2448BODR</b>	1725	1896	1896	2009	2170	2245	2391	2623	2800	3000	3409	3844
<b>BRTSE2448BODL</b>	1725	1821	1896	2009	2170	2245	2391	2623	2800	3000	3409	3844

OVERALL DIMENSIONS			SEAT DIMENSIONS			BACK DIMENSIONS		
W	D	H	W	D	H	W	H	
24	48	29	-	-	-	-	-	

**RTA 00**

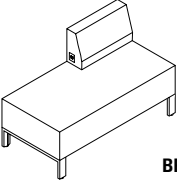

**BRTSE2148EBR**

**Lounge Seat, 21" USB Backrest**  
 COM Yardage: 3  
 Freight Class: 250  
 Product Weight (lbs.): 33  
 Cubic Feet Per Carton: 9.67

	1	2	3	4	5	6	7	8	9	10	11	12
<b>BRTSE2148EBR</b>	1612	1685	1741	1826	1946	2003	2112	2285	2420	2568	2874	3202
<b>BRTSE2148EBL</b>	1612	1685	1741	1826	1946	2003	2112	2285	2420	2568	2874	3202

OVERALL DIMENSIONS			SEAT DIMENSIONS			BACK DIMENSIONS		
W	D	H	W	D	H	W	H	
24	48	29	-	-	-	-	-	

**RTA 00**

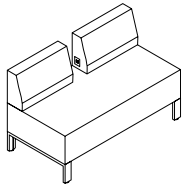

**Lounge Seat, Two 21" USB Backrests**  
 COM Yardage: 4  
 Freight Class: 250  
 Product Weight (lbs.): 57  
 Cubic Feet Per Carton: 19.33

	1	2	3	4	5	6	7	8	9	10	11	12
<b>BRTSE2148E2B</b>	2167	2262	2337	2450	2611	2687	2832	3064	3242	3440	3849	4285

OVERALL DIMENSIONS			SEAT DIMENSIONS			BACK DIMENSIONS		
W	D	H	W	D	H	W	H	
24	48	29	-	-	-	-	-	

**RTA 00**

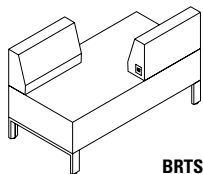

**BRTSE2148EBODR**

**Lounge Seat, Two Offset USB Backrests**  
 COM Yardage: 4  
 Freight Class: 250  
 Product Weight (lbs.): 57  
 Cubic Feet Per Carton: 19.33

	1	2	3	4	5	6	7	8	9	10	11	12
<b>BRTSE2148EBODR</b>	2167	2262	2337	2450	2611	2687	2832	3064	3242	3440	3849	4285
<b>BRTSE2148EBODL</b>	2167	2262	2337	2450	2611	2687	2832	3064	3242	3440	3849	4285

OVERALL DIMENSIONS			SEAT DIMENSIONS			BACK DIMENSIONS		
W	D	H	H	W	D	H	WH	
24	48	29	-	-	-	-	-	

**RTA 00**

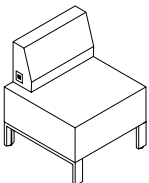

**BRTSE2124EBR**

**Lounge Seat, 21" USB Backrest**  
 COM Yardage: 2.25  
 Freight Class: 250  
 Product Weight (lbs.): 46.10  
 Cubic Feet Per Carton: 19.33

	1	2	3	4	5	6	7	8	9	10	11	12
<b>BRTSE2124EBR</b>	2167	1189	1232	1295	1385	1428	1510	1640	1740	1852	2082	2327
<b>BRTSE2124EBL</b>	1135	1189	1232	1295	1385	1428	1510	1640	1740	1852	2082	2327

OVERALL DIMENSIONS			SEAT DIMENSIONS			BACK DIMENSIONS		
W	D	H	W	D	H	W	H	
24	24	29	-	-	-	-	-	

**RTA 00**

# LOUNGE

# BRIDGES II COLLABORATIVE SEATING B

DESCRIPTION	FEATURES	MODEL#	STANDARD TEXTILE GRADES											
-------------	----------	--------	-------------------------	--	--	--	--	--	--	--	--	--	--	--

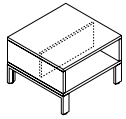

**Low Table - 24"**  
 COM Yardage: N/A  
 Freight Class: 125  
 Product Weight (lbs.): 40.70  
 Cubic Feet Per Carton: 5.67

OVERALL DIMENSIONS			SEAT DIMENSIONS			BACK DIMENSIONS	
W	D	H	W	D	H	W	H
24	24	17	-	-	-	-	-

**RTA 00**

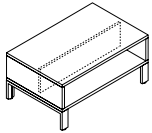

**Low Table - 48"**  
 COM Yardage: N/A  
 Freight Class: 125  
 Product Weight (lbs.): 69  
 Cubic Feet Per Carton: 11.33

OVERALL DIMENSIONS			SEAT DIMENSIONS			BACK DIMENSIONS	
W	D	H	W	D	H	W	H
24	48	17	-	-	-	-	-

**RTA 00**

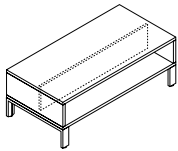

**Low Table - 60"**  
 COM Yardage: N/A  
 Freight Class: 150  
 Product Weight (lbs.): 83.60  
 Cubic Feet Per Carton: 14.17

OVERALL DIMENSIONS			SEAT DIMENSIONS			BACK DIMENSIONS	
W	D	H	W	D	H	W	H
24	60	17	-	-	-	-	-

**RTA 00**

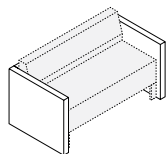

**Seat Partitions - 24"**  
 COM Yardage: 2.50  
 Freight Class: 250  
 Product Weight (lbs.): 32  
 Cubic Feet Per Carton: 12.04

OVERALL DIMENSIONS			SEAT DIMENSIONS			BACK DIMENSIONS	
W	D	H	W	D	H	W	H
53	28.7	25	-	-	-	-	-

**RTA 00**

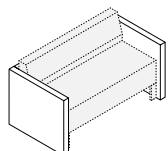

**Seat Partitions - 48"**  
 COM Yardage: 3.25  
 Freight Class: 300  
 Product Weight (lbs.): 41  
 Cubic Feet Per Carton: 22.01

OVERALL DIMENSIONS			SEAT DIMENSIONS			BACK DIMENSIONS	
W	D	H	W	D	H	W	H
53	28.7	25	-	-	-	-	-

**RTA 00**

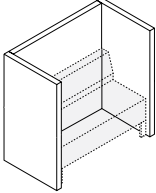
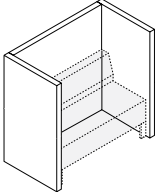
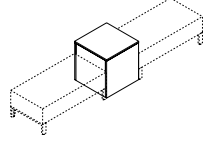
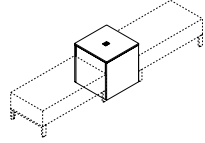
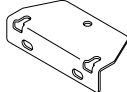
DESCRIPTION	FEATURES	MODEL#	STANDARD TEXTILE GRADES													
			1	2	3	4	5	6	7	8	9	10	11	12		
 <p><b>Seat Privacy Partitions - 24"</b> COM Yardage: 5 Freight Class: 300 Product Weight (lbs.): 32 Cubic Feet Per Carton: 24.08</p>	<p>Fully 3 - Part Kit  Seating not included. Panel textiles only.</p>	<b>BRTPP2424L2</b>	1623	-	-	-	-	-	-	-	-	-	-	-		
			<b>OVERALL DIMENSIONS</b>			<b>SEAT DIMENSIONS</b>			<b>BACK DIMENSIONS</b>							
			<b>W</b>	<b>D</b>	<b>H</b>	<b>W</b>	<b>D</b>	<b>H</b>	<b>W</b>	<b>H</b>						
			53	28.7	50	-	-	-	-	-						
			<b>RTA 00</b>													
 <p><b>Seat Privacy Partitions - 48"</b> COM Yardage: 6.50 Freight Class: 400 Product Weight (lbs.): 41 Cubic Feet Per Carton: 44.01</p>	<p>Fully 3 - Part Kit Seating not included.</p>	<b>BRTPP2448L2</b>	2077	-	-	-	-	-	-	-	-	-	-			
			<b>OVERALL DIMENSIONS</b>			<b>SEAT DIMENSIONS</b>			<b>BACK DIMENSIONS</b>							
			<b>W</b>	<b>D</b>	<b>H</b>	<b>W</b>	<b>D</b>	<b>H</b>	<b>W</b>	<b>H</b>						
			53	28.7	50	-	-	-	-	-						
			<b>RTA 00</b>													
 <p><b>Square Table Block - No Power</b> COM Yardage: N/A Freight Class: 250 Product Weight (lbs.): 32 Cubic Feet Per Carton: 12.04</p>	<p>Freestanding Table. Seating not included. Includes 2 brackets and screws</p>	<b>BRTS2424B</b>	455	-	-	-	-	-	-	-	-	-	-			
			<b>OVERALL DIMENSIONS</b>			<b>SEAT DIMENSIONS</b>			<b>BACK DIMENSIONS</b>							
			<b>W</b>	<b>D</b>	<b>H</b>	<b>W</b>	<b>D</b>	<b>H</b>	<b>W</b>	<b>H</b>						
			24	24	25	-	-	-	-	-						
			<b>RTA 00</b>													
 <p><b>Square Table Block w/ Center Power</b> COM Yardage: N/A Freight Class: 125 Product Weight (lbs.): 59.30 Cubic Feet Per Carton: 8.33</p>	<p>Freestanding Table. Seating not included. Includes 2 brackets and screws</p>	<b>BRTS2424BP</b>	455	-	-	-	-	-	-	-	-	-	-			
			<b>OVERALL DIMENSIONS</b>			<b>SEAT DIMENSIONS</b>			<b>BACK DIMENSIONS</b>							
			<b>W</b>	<b>D</b>	<b>H</b>	<b>W</b>	<b>D</b>	<b>H</b>	<b>W</b>	<b>H</b>						
			24	24	25	-	-	-	-	-						
			<b>RTA 00</b>													
 <p><b>Square Table Block Ganging Bracket Kit</b> COM Yardage: N/A Freight Class: 70 Product Weight (lbs.): 0.05 Cubic Feet Per Carton: 0.01</p>	<p>Includes 2 brackets and screws. Black Only.</p>	<b>BRTSTBG</b>	33	-	-	-	-	-	-	-	-	-	-			
			<b>OVERALL DIMENSIONS</b>			<b>SEAT DIMENSIONS</b>			<b>BACK DIMENSIONS</b>							
			<b>W</b>	<b>D</b>	<b>H</b>	<b>W</b>	<b>D</b>	<b>H</b>	<b>W</b>	<b>H</b>						
			2.5	5	1.1	-	-	-	-	-						
			<b>RTA 00</b>													

# LOUNGE

# BRIDGES II COLLABORATIVE SEATING B

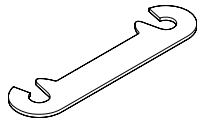
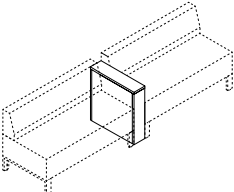
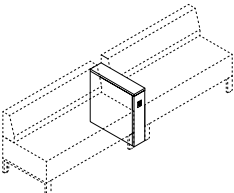
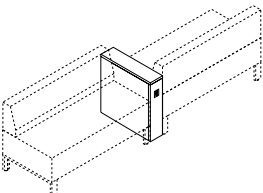
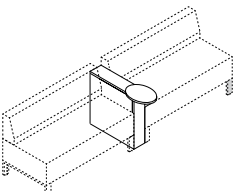
DESCRIPTION	FEATURES	MODEL#	STANDARD TEXTILE GRADES													
			1	2	3	4	5	6	7	8	9	10	11	12		
 <p><b>Ganging Bracket Kit</b> COM Yardage: N/A Freight Class: 70 Product Weight (lbs.): 0.03 Cubic Feet Per Carton: 0.01</p>		BRTSTSB	14	-	-	-	-	-	-	-	-	-	-	-	-	
			<b>OVERALL DIMENSIONS</b>			<b>SEAT DIMENSIONS</b>			<b>BACK DIMENSIONS</b>							
			W	D	H	W	D	H	W	H						
			1.3	6	0.1	-	-	-	-	-	-	-	-			
			<b>RTA 00</b>													
 <p><b>Inline 6" Table Block</b> COM Yardage: N/A Freight Class: 92.50 Product Weight (lbs.): 21 Cubic Feet Per Carton: 2.08</p>	<p>Must use with seating. Seating not included. Includes 2 brackets and screws</p>	BRTS2406B	390	-	-	-	-	-	-	-	-	-	-	-	-	
			<b>OVERALL DIMENSIONS</b>			<b>SEAT DIMENSIONS</b>			<b>BACK DIMENSIONS</b>							
			W	D	H	W	D	H	W	H						
			24	6	25	-	-	-	-	-	-	-	-			
			<b>RTA 00</b>													
 <p><b>Inline 6" Table Block w/ Front Power</b> COM Yardage: N/A Freight Class: 92.50 Product Weight (lbs.): 23.30 Cubic Feet Per Carton: 2.08</p>	<p>Must use with seating. Seating not included. Includes 2 brackets and screws</p>	BRTS2406BP	844	-	-	-	-	-	-	-	-	-	-	-	-	
			<b>OVERALL DIMENSIONS</b>			<b>SEAT DIMENSIONS</b>			<b>BACK DIMENSIONS</b>							
			W	D	H	W	D	H	W	H						
			24	6	25	-	-	-	-	-	-	-	-			
			<b>RTA 00</b>													
 <p><b>Inline 6" Table Block w/ Front &amp; Rear Power</b> COM Yardage: N/A Freight Class: 92.50 Product Weight (lbs.): 24.30 Cubic Feet Per Carton: 2.08</p>	<p>Must use with seating. Seating not included. Includes 2 brackets and screws</p>	BRTS2406B2P	1298	-	-	-	-	-	-	-	-	-	-	-	-	
			<b>OVERALL DIMENSIONS</b>			<b>SEAT DIMENSIONS</b>			<b>BACK DIMENSIONS</b>							
			W	D	H	W	D	H	W	H						
			24	6	25	-	-	-	-	-	-	-	-			
			<b>RTA 00</b>													
 <p><b>Inline 6" Table Block w/ Tablet Arm</b> COM Yardage: N/A Freight Class: 85 Product Weight (lbs.): 25.60 Cubic Feet Per Carton: 2.08</p>	<p>Must use with seating. Seating not included. Includes 2 brackets and screws</p>	BRTS2406BT	747	-	-	-	-	-	-	-	-	-	-	-	-	
			<b>OVERALL DIMENSIONS</b>			<b>SEAT DIMENSIONS</b>			<b>BACK DIMENSIONS</b>							
			W	D	H	W	D	H	W	H						
			24	6	25	-	-	-	-	-	-	-	-			
			<b>RTA 00</b>													

DESCRIPTION	FEATURES	MODEL#	STANDARD TEXTILE GRADES											
-------------	----------	--------	-------------------------	--	--	--	--	--	--	--	--	--	--	--

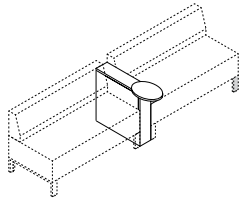

**Inline 6" Table Block w/ Front Power & Tablet Arm**  
 COM Yardage: N/A  
 Freight Class: 92.50  
 Product Weight (lbs.): 24.30  
 Cubic Feet Per Carton: 2.08

Must use with seating.  
 Seating not included.  
 Includes 2 brackets and screws

	1	2	3	4	5	6	7	8	9	10	11	12
<b>BRTS2406BPT</b>	1201	-	-	-	-	-	-	-	-	-	-	-

OVERALL DIMENSIONS			SEAT DIMENSIONS			BACK DIMENSIONS	
W	D	H	W	D	H	W	H
24	6	25	-	-	-	-	-

**RTA 00**

CAMINO



models shown: 5471-CP Lounge Chair, 5475-W End Table, 5472-CP Two Seat Sofa.



model 5471-CP



model 5476-W



model 5485-W

STANDARD FEATURES

- A transitional soft seating series composed of one, two and three seat units. The series also offers tables with coordinating details and finishes.
- Frame is a heavy duty, interlocking plywood, puzzle box construction suitable for public environments.
- The soft seating leg system utilizes a continuous visible frame between the front and rear leg. Each leg frame is bolted directly to the sofa frame with large bolts to provide a very durable leg construction.
- Legs are equipped with translucent non marking glides as standard. Suitable for both carpet and hard surface flooring.
- Seating features as standard, decorative double stitch detail, which make seams lay flat and add extra seam strength.
- Cushions are highly resilient foam and seats are equipped with a synthetic rubberized sheet webbing suspension system for extra comfort. Cushions are fixed and non-removable.
- Tables are made with a choice of tops: Genuine Wood tops (**W**) with a reverse beveled edge, Thermally Fused Laminate tops (**LP**) with matching PVC edging or High Pressure Laminate top (**HP**) with matching PVC edging. Custom high pressure laminate finishes will be considered upon requested.
- Regardless of top chosen all tables have wood aprons and a unique tapered leg design.
- Some table assembly required, see RTA code with each item below.
- Measurement shown for weight is for one unit, measurement for volume is per carton.

OPTIONAL FEATURES

- Optional cushions and arms can have tailored piping details.
- For piping made in fabric matching the rest of the upholstery fabric please use **MP** models (matching piping after the model number). This is no upcharge.
- For contrast piping made in a fabric that does not match the rest of the upholstery fabric, you can specify any grade 1 or 2 upholstery material for this purpose, please see model numbers ending in **CP** which reflect the appropriate upcharge.
- For contrast piping in a fabric higher than grade 2, you must ask for a special quotation. Per unit price will vary depending on the number of units being ordered.
- Upholstery options: fabric, vinyl, leather or leather/mock leather combination. Not available in Crescent fabric. If a two tone fabric or a fabric / leather combination is required please fill in a fabric combination sketch showing which material goes where. Please contact Customer Care.
- Seating unit and tables come with a choice of wood legs or a polished cast aluminum. The table leg finishes coordinate with the legs on the soft seating units.
- Seating and tables with polished aluminum legs are shown as separate skus.
- Tops finishes coordinate with the laminate finishes for Global Desking and wood seating finishes. Specify laminate finishes from the Adaptabilities or Zira sections of the price list.
- Wood legs for seating are available in select Global wood seating finishes - see seating finishes. Only finishes ending in "**M**" are available for this series.

DESCRIPTION FEATURES MODEL# STANDARD TEXTILE GRADES



**Lounge Chair w/ Wood Legs**  
COM Yardage: 4  
Freight Class: 250  
Product Weight (lbs.): 60  
Cubic Feet Per Carton: 19.25

No Piping.

MODEL#	1	2	3	4	5	6	7	8	9	10	11	12
<b>5471</b>	1845	1956	2046	2179	2368	2456	2628	2901	3110	3345	3827	4340
<b>5471LM</b>	-	-	-	-	2326	--	--	2861	3070	3305	3785	4300

OVERALL DIMENSIONS			SEAT DIMENSIONS			BACK DIMENSIONS	
W	D	H	W	D	H	W	H
29.5	29	30.5	21	19.5	18	20	11.5

RTA 00



**Lounge Chair w/ Wood Legs & Piping**  
COM Yardage: 4  
Freight Class: 250  
Product Weight (lbs.): 60  
Cubic Feet Per Carton: 19.25



CP = Contrast Piping  
MP = Matching Piping

MODEL#	1	2	3	4	5	6	7	8	9	10	11	12
<b>5471-CP</b>	1985	2097	2186	2319	2508	2596	2768	3041	3250	3485	3966	4480
<b>5471LM-CP</b>	-	-	-	-	2363	--	--	2898	3107	3342	3824	4337
<b>5471-MP</b>	1845	1956	2046	2179	2368	2456	2628	2901	3110	3345	3827	4340
<b>5471LM-MP</b>	-	-	-	-	2326	--	--	2861	3070	3305	3785	4300

OVERALL DIMENSIONS			SEAT DIMENSIONS			BACK DIMENSIONS	
W	D	H	W	D	H	W	H
29.5	29	30.5	21	19.5	18	20	11.5

RTA 00

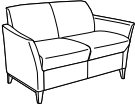
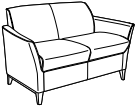
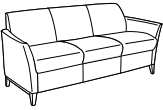
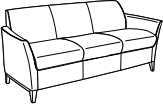

DESCRIPTION	FEATURES	MODEL#	STANDARD TEXTILE GRADES													
			1	2	3	4	5	6	7	8	9	10	11	12		
 <p><b>Two Seat Sofa w/ Wood Legs</b> COM Yardage: 5.75 Freight Class: 250 Product Weight (lbs.): 84 Cubic Feet Per Carton: 36</p>	No Piping.	5472	2615	2775	2902	3094	3366	3492	3739	4131	4434	4770	5463	6200		
		5472LM	-	-	-	-	3307	--	--	4073	4376	4712	5404	6142		
		<b>OVERALL DIMENSIONS</b>			<b>SEAT DIMENSIONS</b>			<b>BACK DIMENSIONS</b>								
		<b>W D H</b>			<b>W D H</b>			<b>W H</b>								
		51 29 30.5			42 19.5 18			41 11.5								
		<b>RTA 00</b>														
		 <p><b>Two Seat Sofa w/ Wood Legs</b> COM Yardage: 5.75 Freight Class: 250 Product Weight (lbs.): 84 Cubic Feet Per Carton: 36</p>	CP = Contrast Piping MP = Matching Piping	5472-CP	2801	2962	3088	3281	3553	3680	3926	4318	4620	4957	5649	6386
				5472LM-CP	-	-	-	-	3346	--	--	4112	4415	4752	5444	6200
				5472-MP	2615	2775	2902	3094	3366	3492	3739	4131	4434	4770	5463	6200
				5472LM-MP	-	-	-	-	3307	--	--	4073	4376	4712	5404	6142
<b>OVERALL DIMENSIONS</b>				<b>SEAT DIMENSIONS</b>			<b>BACK DIMENSIONS</b>									
<b>W D H</b>				<b>W D H</b>			<b>W H</b>									
51 29 30.5				42 19.5 18			41 11.5									
<b>RTA 00</b>																
 <p><b>Three Seat Sofa w/ Wood Legs</b> COM Yardage: 7.50 Freight Class: 250 Product Weight (lbs.): 110 Cubic Feet Per Carton: 50.25</p>	No Piping.			5473	3384	3593	3759	4009	4364	4529	4851	5363	5757	6196	7099	8061
				5473LM	-	-	-	-	4287	--	--	5287	5682	6121	7023	7986
		<b>OVERALL DIMENSIONS</b>			<b>SEAT DIMENSIONS</b>			<b>BACK DIMENSIONS</b>								
		<b>W D H</b>			<b>W D H</b>			<b>W H</b>								
		71 29 30.5			63 19.5 18			62 11.5								
		<b>RTA 00</b>														
		 <p><b>Three Seat Sofa w/ Wood Legs</b> COM Yardage: 7.50 Freight Class: 250 Product Weight (lbs.): 110 Cubic Feet Per Carton: 50.25</p>	CP = Contrast Piping MP = Matching Piping	5473-CP	3617	3826	3993	4242	4596	4762	5085	5595	5990	6429	7331	8294
				5473LM-CP	-	-	-	-	4329	--	--	5329	5723	6162	7065	8294
				5473-MP	3384	3593	3759	4009	4364	4529	4851	5363	5757	6196	7099	8061
				5473LM-MP	-	-	-	-	4287	--	--	5287	5682	6121	7023	7986
<b>OVERALL DIMENSIONS</b>				<b>SEAT DIMENSIONS</b>			<b>BACK DIMENSIONS</b>									
<b>W D H</b>				<b>W D H</b>			<b>W H</b>									
71 29 30.5				63 19.5 18			62 11.5									
<b>RTA 00</b>																
 <p><b>Coffee Table - 22" x 48" Rectangular w/Wood Legs</b> COM Yardage: N/A Freight Class: 92.5 Product Weight (lbs.): 40 Cubic Feet Per Carton: 4</p>				5474-LP	1425	-	-	-	-	-	-	-	-	-	-	-
				5474-HP	1529	-	-	-	-	-	-	-	-	-	-	-
		5474-W	1840	-	-	-	-	-	-	-	-	-	-	-	-	
		LP = Laminate Top    HP = High Pressure Laminate Top    W = Wood Top														
		<b>OVERALL DIMENSIONS</b>			<b>SEAT DIMENSIONS</b>			<b>BACK DIMENSIONS</b>								
		<b>W D H</b>			<b>W D H</b>			<b>W H</b>								
		22 48 17.5			-			-			-					
		<b>RTA 8</b>														

DESCRIPTION	FEATURES	MODEL#	STANDARD TEXTILE GRADES											
			1	2	3	4	5	6	7	8	9	10	11	12



**End Table - 21" x 21" Square w/Wood Legs**  
 COM Yardage: N/A  
 Freight Class: 100  
 Product Weight (lbs.): 20  
 Cubic Feet Per Carton: 2.10

MODEL#	STANDARD TEXTILE GRADES											
	1	2	3	4	5	6	7	8	9	10	11	12
5475-LP	1061	-	-	-	-	-	-	-	-	-	-	-
5475-HP	1166	-	-	-	-	-	-	-	-	-	-	-
5475-W	1285	-	-	-	-	-	-	-	-	-	-	-
LP = Laminate Top HP = High Pressure Laminate Top W = Wood Top												
OVERALL DIMENSIONS			SEAT DIMENSIONS			BACK DIMENSIONS						
W	D	H	W	D	H	W	H					
21	21	17.5	-	-	-	-	-					
<b>RTA 8</b>												



**End Table - 24" Round w/Wood Legs**  
 COM Yardage: N/A  
 Freight Class: 85  
 Product Weight (lbs.): 27  
 Cubic Feet Per Carton: 2.10

MODEL#	STANDARD TEXTILE GRADES											
	1	2	3	4	5	6	7	8	9	10	11	12
5476-LP	1098	-	-	-	-	-	-	-	-	-	-	-
5476-HP	1204	-	-	-	-	-	-	-	-	-	-	-
5476-W	1396	-	-	-	-	-	-	-	-	-	-	-
LP = Laminate Top HP = High Pressure Laminate Top W = Wood Top												
OVERALL DIMENSIONS			SEAT DIMENSIONS			BACK DIMENSIONS						
W	D	H	W	D	H	W	H					
24	24	17.5	-	-	-	-	-					
<b>RTA 8</b>												



**Coffee Table - 32" Round w/Wood Legs**  
 COM Yardage: N/A  
 Freight Class: 125  
 Product Weight (lbs.): 35  
 Cubic Feet Per Carton: 4.40

MODEL#	STANDARD TEXTILE GRADES											
	1	2	3	4	5	6	7	8	9	10	11	12
5477-LP	1659	-	-	-	-	-	-	-	-	-	-	-
5477-HP	1763	-	-	-	-	-	-	-	-	-	-	-
5477-W	2097	-	-	-	-	-	-	-	-	-	-	-
LP = Laminate Top HP = High Pressure Laminate Top W = Wood Top												
OVERALL DIMENSIONS			SEAT DIMENSIONS			BACK DIMENSIONS						
W	D	H	W	D	H	W	H					
32	32	17.5	-	-	-	-	-					
<b>RTA 8</b>												



**Lounge Chair w/Aluminum Legs**  
 COM Yardage: 4  
 Freight Class: 250  
 Product Weight (lbs.): 62  
 Cubic Feet Per Carton: 19.25

No Piping.



MODEL#	STANDARD TEXTILE GRADES											
	1	2	3	4	5	6	7	8	9	10	11	12
5481	1845	1956	2046	2179	2368	2456	2628	2901	3110	3345	3827	4340
5481LM	-	-	-	-	2224	--	--	2969	3202	3684	4197	3202
LP = Laminate Top HP = High Pressure Laminate Top W = Wood Top												
OVERALL DIMENSIONS			SEAT DIMENSIONS			BACK DIMENSIONS						
W	D	H	W	D	H	W	H					
29.5	29	30.5	21	19.5	18	20	11.5					
<b>RTA 00</b>												



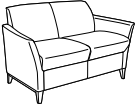
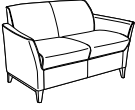
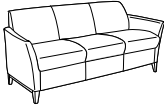
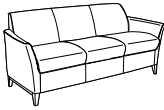

**Lounge Chair w/Aluminum Legs**  
 COM Yardage: 4  
 Freight Class: 250  
 Product Weight (lbs.): 62  
 Cubic Feet Per Carton: 19.25

CP = Contrast Piping.  
 MP = Matching Piping.

MODEL#	STANDARD TEXTILE GRADES											
	1	2	3	4	5	6	7	8	9	10	11	12
5481-CP	1985	2097	2186	2319	2508	2596	2768	3041	3250	3485	3966	4480
5481LM-CP	-	-	-	-	2363	--	--	2898	3107	3342	3824	4337
5481-MP	1845	1956	2046	2179	2368	2456	2628	2901	3110	3345	3827	4340
5481LM-MP	-	-	-	-	2224	--	--	2758	2969	3202	3684	4197
LP = Laminate Top HP = High Pressure Laminate Top W = Wood Top												
OVERALL DIMENSIONS			SEAT DIMENSIONS			BACK DIMENSIONS						
W	D	H	W	D	H	W	H					
29.5	29	30.5	21	19.5	18	20	11.5					
<b>RTA 00</b>												

DESCRIPTION	FEATURES	MODEL#	STANDARD TEXTILE GRADES												
			1	2	3	4	5	6	7	8	9	10	11	12	
 <p><b>Two Seat Sofa w/ Aluminum Legs</b> COM Yardage: 5.75 Freight Class: 250 Product Weight (lbs.): 86 Cubic Feet Per Carton: 36</p>	No Piping.	5482	2615	2775	2902	3094	3366	3492	3739	4131	4434	4770	5463	6200	
		5482LM	-	-	-	-	3205	3051	3277	3971	4273	4610	5302	6039	
		<b>OVERALL DIMENSIONS</b>			<b>SEAT DIMENSIONS</b>			<b>BACK DIMENSIONS</b>							
		W	D	H	W	D	H	W	H						
			51	29	30.5	42	19.5	18			41	11.5			
			<b>RTA 00</b>												
 <p><b>Two Seat Sofa w/ Aluminum Legs</b> COM Yardage: 5.75 Freight Class: 250 Product Weight (lbs.): 86 Cubic Feet Per Carton: 36</p>	CP = Contrast Piping. MP = Matching Piping.	5482-CP	2801	2962	3088	2962	3088	3281	3553	3680	3926	4318	4620	6386	
		5482LM-CP	-	-	-	-	3346	3051	3277	4112	4415	4752	5444	6182	
		5482-MP	2615	2775	2902	3094	3366	3492	3739	4131	4434	4770	5463	6200	
		5482LM-MP	-	-	-	-	3205	3051	3277	3971	4273	4610	5302	6039	
			<b>OVERALL DIMENSIONS</b>			<b>SEAT DIMENSIONS</b>			<b>BACK DIMENSIONS</b>						
W	D	H	W	D	H	W	H								
			51	29	30.5	42	19.5	18			41	11.5			
			<b>RTA 00</b>												
 <p><b>Three Seat Sofa w/ Aluminum Legs</b> COM Yardage: 7.50 Freight Class: 250 Product Weight (lbs.): 112 Cubic Feet Per Carton: 50.25</p>	No Piping.	5483	3384	3593	3759	3593	4364	4529	4851	5363	5757	6196	7099	8061	
		5483LM	-	-	-	-	4184	--	--	5184	5579	6018	6921	7884	
		<b>OVERALL DIMENSIONS</b>			<b>SEAT DIMENSIONS</b>			<b>BACK DIMENSIONS</b>							
		W	D	H	W	D	H	W	H						
			71	29	30.5	63	19.5	18			62	11.5			
			<b>RTA 00</b>												
 <p><b>Three Seat Sofa w/ Aluminum Legs</b> COM Yardage: 7.50 Freight Class: 250 Product Weight (lbs.): 112 Cubic Feet Per Carton: 50.25</p>	CP = Contrast Piping. MP = Matching Piping.	5483-CP	3617	3826	3993	4242	4596	4762	5085	5595	5990	6294	7331	8294	
		5483LM-CP	-	-	-	-	4329	--	--	5329	5723	6162	7065	8028	
		5483-MP	3384	3593	3759	4009	4364	4529	4851	5363	5757	6196	7099	8061	
		5483LM-MP	-	-	-	-	4184	--	--	5184	5579	6018	6921	7884	
			<b>OVERALL DIMENSIONS</b>			<b>SEAT DIMENSIONS</b>			<b>BACK DIMENSIONS</b>						
W	D	H	W	D	H	W	H								
			71	29	30.5	63	19.5	18			62	11.5			
			<b>RTA 00</b>												
 <p><b>Coffee Table - 22" x 48" Rectangular w/ Aluminum Legs</b> COM Yardage: N/A Freight Class: 92.5 Product Weight (lbs.): 46 Cubic Feet Per Carton: 4</p>		5484-LP	1504	-	-	-	-	-	-	-	-	-	-	-	
		5484-HP	1609	-	-	-	-	-	-	-	-	-	-	-	-
		5484-W	1919	-	-	-	-	-	-	-	-	-	-	-	-
		<b>LP = Laminate Top HP = High Pressure Laminate Top W = Wood Top</b>			<b>OVERALL DIMENSIONS</b>			<b>SEAT DIMENSIONS</b>			<b>BACK DIMENSIONS</b>				
W	D	H	W	D	H	W	H								
			22	48	17.5	-	-	-			-	-			
			<b>RTA 8</b>												

DESCRIPTION	FEATURES	MODEL#	STANDARD TEXTILE GRADES											
			1	2	3	4	5	6	7	8	9	10	11	12
 <p><b>End Table - 21" x 21" Square w/Aluminum Legs</b>                      COM Yardage: N/A                      Freight Class: 85                      Product Weight (lbs.): 26                      Cubic Feet Per Carton: 2.10</p>														
	5485-LP	1140	-	-	-	-	-	-	-	-	-	-	-	-
	5485-HP	1245	-	-	-	-	-	-	-	-	-	-	-	-
	5485-W	1363	-	-	-	-	-	-	-	-	-	-	-	-
	LP = Laminate Top    HP = High Pressure Laminate Top    W = Wood Top			OVERALL DIMENSIONS			SEAT DIMENSIONS			BACK DIMENSIONS				
	W	D	H	W	D	H	W	H						
	21	21	17.5	-	-	-	-	-						
	<b>RTA 8</b>													
 <p><b>End Table - 24" Round w/Aluminum Legs</b>                      COM Yardage: N/A                      Freight Class: 85                      Product Weight (lbs.): 27                      Cubic Feet Per Carton: 2.10</p>														
	5486-LP	1177	-	-	-	-	-	-	-	-	-	-	-	-
	5486-HP	1282	-	-	-	-	-	-	-	-	-	-	-	-
	5486-W	1476	-	-	-	-	-	-	-	-	-	-	-	-
	LP = Laminate Top    HP = High Pressure Laminate Top    W = Wood Top			OVERALL DIMENSIONS			SEAT DIMENSIONS			BACK DIMENSIONS				
	W	D	H	W	D	H	W	H						
	24	24	17.5	-	-	-	-	-						
	<b>RTA 8</b>													
 <p><b>Coffee Table - 32" Round w/Aluminum Legs</b>                      COM Yardage: N/A                      Freight Class: 100                      Product Weight (lbs.): 41                      Cubic Feet Per Carton: 4.40</p>														
	5487-LP	1737	-	-	-	-	-	-	-	-	-	-	-	-
	5487-HP	1842	-	-	-	-	-	-	-	-	-	-	-	-
	5487-W	2176	-	-	-	-	-	-	-	-	-	-	-	-
	LP = Laminate Top    HP = High Pressure Laminate Top    W = Wood Top			OVERALL DIMENSIONS			SEAT DIMENSIONS			BACK DIMENSIONS				
	W	D	H	W	D	H	W	H						
	32	32	17.5	-	-	-	-	-						
	<b>RTA 8</b>													

CITI™



model 7875LTM (BK)



model 7889



Citi Modular Group & Tables - Shown in Tungsten

STANDARD FEATURES

- Compact, contemporary design includes raised legs, ideal where space is at a premium.
- Fully upholstered. Fixed seat and back cushions. Raised metal tubular legs.
- Horizontal stitch detail on leather models only. Fabric models will not have decorative stitch detail.
- Citi seat and table legs are standard in a Tungsten (R1) colored finish.
- Citi tables complement the contemporary timeless decor of many offices
- Table tops are available in either tempered glass or laminate.



OPTIONAL FEATURES

- For highly resilient, high density Ultracell foam on seat, please specify (UC) after the model number. One seater add \$99. Two Seater add \$197. Three Seater add \$295.
- Legs are available in Black (R2) finish at no charge. Chrome (R3) finish is available. Add \$80.

- Wood feet are available as an option (non-cylindrical) for Citi Seating only. Add \$227. Please inquire with Customer Care for available finishes.
- Citi tables and tablets are offered in the following laminate finishes: Absolute Acajou (ACJ), Asian Night (ASN), Avant Cherry (AWC), Avant Honey (AWH), Black (BLK), Brushed Cobalt (BRC), Clear Maple (CMB), Dark Espresso (DES), Designer White (DWT), Hayden Grey (HGT), Quartered Mahogany (QTM), Storm Grey (SOG), Tiger Fruitwood (TFW), Tiger Walnut (TWL), Walnut Heights (WHE), White Chocolate (WHC), Willow Grey (WGY), and Winter Cherry (WCR). Please specify.
- Tablets are also offered in Charcoal or White MDF. Please specify.
- Upon request, Citi seating can be upholstered in Fabric or Vinyl. Not available in Crescent fabric. Please specify (F) after the first four digits of the model number when ordering, for example: 7895F, 7877FLTM, 7890FR. Contact your Global sales representative for further information. Please refer to Grade 5 list prices for lower grades.

SAMPLE LAYOUTS

Layout A

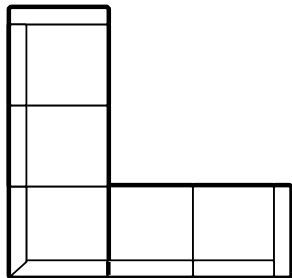

Qty	Model Number	Description	Dimensions	List Price
1	7890LNB	Two Seat Sofa w/Left Arm	48 x 31 x 30.75	1499
1	7862	Corner Seat	37 x 37 x 31	1626
1	7890RNB	Two Seat Sofa w/Right Arm	48 x 31 x 30.75	1499
2	7892	Ganging Bracket	0.5 x 3.87 x 2	21

SAMPLE LAYOUT TOTAL IN STANDARD FEET FINISH 4645

Layout B

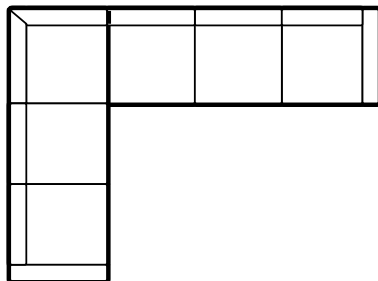

Qty	Model Number	Description	Dimensions	List Price
1	7890RNB	Two Seat Sofa w/Right Arm	48 x 31 x 30.75	1499
1	7862	Corner Seat	37 x 37 x 31	1626
1	7891LNB	Three Seat Sofa w/Left Arm	77 x 31 x 30.75	2001
2	7892	Ganging Bracket	0.5 x 3.87 x 2	21 x 2

SAMPLE LAYOUT TOTAL IN STANDARD FEET FINISH 5168



Ganging Bracket

COM Yardage: N/a  
Freight Class: 70  
Product Weight (lbs.): .25  
Cubic Feet Per Carton: .01

Kit includes 2 brackets, 4 screws and a template.

	1	2	3	4	5	6	7	8	9	10	11	12
7892	21	-	-	-	-	-	-	-	-	-	-	-

OVERALL DIMENSIONS			SEAT DIMENSIONS			BACK DIMENSIONS	
W	D	H	W	D	H	W	H



- - - - -

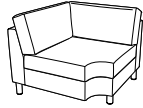



DESCRIPTION	FEATURES	MODEL#	STANDARD TEXTILE GRADES											
			1	2	3	4	5	6	7	8	9	10	11	12
 <b>Corner Seat</b> COM Yardage: 6.25 Freight Class: 250 Product Weight (lbs.): 65 Cubic Feet Per Carton: 30.25		<b>7862</b>	-	-	-	-	1626	1749	1987	2414	2657	3052	3650	4363
		<b>7862LF</b>	-	-	-	-	2017	2141	2379	2806	3049	3445	4042	4754
			<b>OVERALL DIMENSIONS</b>			<b>SEAT DIMENSIONS</b>			<b>BACK DIMENSIONS</b>					
			<b>W</b>	<b>D</b>	<b>H</b>	<b>W</b>	<b>D</b>	<b>H</b>	<b>W</b>	<b>H</b>				
			37	37	30.75	26	26	17.5	26	13.5				
		<b>RTA 00</b>												

DESCRIPTION	FEATURES	MODEL#	STANDARD TEXTILE GRADES											
			1	2	3	4	5	6	7	8	9	10	11	12
 <b>Large Lounge Chair - for 6'+ Tall Users</b> COM Yardage: 5.50 Freight Class: 250 Product Weight (lbs.): 70 Cubic Feet Per Carton: 24.25		<b>7864</b>	-	-	-	-	1442	1552	1760	2136	2351	2698	3223	3851
			<b>OVERALL DIMENSIONS</b>			<b>SEAT DIMENSIONS</b>			<b>BACK DIMENSIONS</b>					
				<b>W</b>	<b>D</b>	<b>H</b>	<b>W</b>	<b>D</b>	<b>H</b>	<b>W</b>	<b>H</b>			
			34	33	30	23	20	19	23	13.5				
		<b>RTA 00</b>												

DESCRIPTION	FEATURES	MODEL#	STANDARD TEXTILE GRADES											
			1	2	3	4	5	6	7	8	9	10	11	12
 <b>Lounge Chair</b> COM Yardage: 4.50 Freight Class: 250 Product Weight (lbs.): 66 Cubic Feet Per Carton: 21		<b>7875</b>	-	-	-	-	1064	1157	1333	1651	1831	2123	2565	3094
		<b>7875LF</b>	-	-	-	-	1353	1446	1626	1949	2133	2431	2883	3420
			<b>OVERALL DIMENSIONS</b>			<b>SEAT DIMENSIONS</b>			<b>BACK DIMENSIONS</b>					
			<b>W</b>	<b>D</b>	<b>H</b>	<b>W</b>	<b>D</b>	<b>H</b>	<b>W</b>	<b>H</b>				
			30	31	30	21	19.5	17.5	21	12.5				
		<b>RTA 00</b>												

DESCRIPTION	FEATURES	MODEL#	STANDARD TEXTILE GRADES											
			1	2	3	4	5	6	7	8	9	10	11	12
  <b>Lounge Chair w/Laminate Tablet</b> COM Yardage: 4.50 Freight Class: 250 Product Weight (lbs.): 74 Cubic Feet Per Carton: 22.50		<b>7875LTL</b>	-	-	-	-	1598	1692	1872	2195	2379	2678	3130	3667
		<b>7875RTL</b>	-	-	-	-	1765	1860	2037	2361	2547	2844	3295	3834
			<b>OVERALL DIMENSIONS</b>			<b>SEAT DIMENSIONS</b>			<b>BACK DIMENSIONS</b>					
			<b>W</b>	<b>D</b>	<b>H</b>	<b>W</b>	<b>D</b>	<b>H</b>	<b>W</b>	<b>H</b>				
			31	33.5	30	21	19.5	17.5	21	12.5				
		<b>RTA 00</b>												

DESCRIPTION	FEATURES	MODEL#	STANDARD TEXTILE GRADES											
			1	2	3	4	5	6	7	8	9	10	11	12
  <b>Lounge Chair w/MDF Tablet</b> COM Yardage: 4.50 Freight Class: 250 Product Weight (lbs.): 74 Cubic Feet Per Carton: 22.50		<b>7875LTM</b>	-	-	-	-	1819	1913	2094	2416	2600	2900	3351	3890
		<b>7875RTM</b>	-	-	-	-	1980	2074	2253	2577	2761	3060	3511	4048
			<b>OVERALL DIMENSIONS</b>			<b>SEAT DIMENSIONS</b>			<b>BACK DIMENSIONS</b>					
			<b>W</b>	<b>D</b>	<b>H</b>	<b>W</b>	<b>D</b>	<b>H</b>	<b>W</b>	<b>H</b>				
			31	33.5	30	21	19.5	17.5	21	12.5				
		<b>RTA 00</b>												

DESCRIPTION	FEATURES	MODEL#	STANDARD TEXTILE GRADES											
			1	2	3	4	5	6	7	8	9	10	11	12
 <p><b>Lounge Chair- Armless</b> COM Yardage: 3 Freight Class: 250 Product Weight (lbs.): 40 Cubic Feet Per Carton: 15.50</p>		<b>7895</b>	-	-	-	-	1066	1125	1240	1445	1561	1751	2037	2379
		<b>7895LF</b> Leather/Fabric	-	-	-	-	1353	1413	1526	1732	1848	2038	2324	2666
		<b>OVERALL DIMENSIONS</b>	<b>W</b>	<b>D</b>	<b>H</b>	<b>SEAT DIMENSIONS</b>			<b>BACK DIMENSIONS</b>					
			21	31	30.75	21	19.5	17.5	21	14				
		<b>RTA 00</b>												

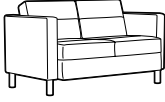
DESCRIPTION	FEATURES	MODEL#	STANDARD TEXTILE GRADES											
			1	2	3	4	5	6	7	8	9	10	11	12
 <p><b>Two Seat Sofa</b> COM Yardage: 6.25 Freight Class: 250 Product Weight (lbs.): 108 Cubic Feet Per Carton: 36</p>		<b>7876</b>	-	-	-	-	1437	1567	1810	2249	2501	2907	3523	4257
		<b>7876LF</b> Leather/Fabric	-	-	-	-	2002	2133	2382	2831	3086	3502	4127	4875
		<b>OVERALL DIMENSIONS</b>	<b>W</b>	<b>D</b>	<b>H</b>	<b>SEAT DIMENSIONS</b>			<b>BACK DIMENSIONS</b>					
			50.5	31	30	42.5	19.5	17.5	42.5	12.5				
		<b>RTA 00</b>												

DESCRIPTION	FEATURES	MODEL#	STANDARD TEXTILE GRADES											
			1	2	3	4	5	6	7	8	9	10	11	12
 <p><b>Two Seat Sofa - Armless</b> COM Yardage: 5 Freight Class: 250 Product Weight (lbs.): 85 Cubic Feet Per Carton: 36</p>		<b>7896</b>	-	-	-	-	1327	1427	1617	1959	2153	2469	2946	3517
		<b>7896LF</b> Leather/Fabric	-	-	-	-	1879	1978	2169	2510	2704	3020	3498	4068
		<b>OVERALL DIMENSIONS</b>	<b>W</b>	<b>D</b>	<b>H</b>	<b>SEAT DIMENSIONS</b>			<b>BACK DIMENSIONS</b>					
			42.5	31	30.75	42.5	19.5	17.5	42.5	12.5				
		<b>RTA 00</b>												

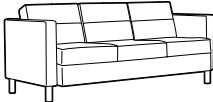
DESCRIPTION	FEATURES	MODEL#	STANDARD TEXTILE GRADES											
			1	2	3	4	5	6	7	8	9	10	11	12
 <p><b>Three Seat Sofa</b> COM Yardage: 8.75 Freight Class: 250 Product Weight (lbs.): 140 Cubic Feet Per Carton: 50.25</p>		<b>7877</b>	-	-	-	-	1809	1987	2329	2947	3299	3868	4729	5756
		<b>7877LF</b> Leather/Fabric	-	-	-	-	2703	2884	3234	3863	4220	4800	5677	6726
		<b>OVERALL DIMENSIONS</b>	<b>W</b>	<b>D</b>	<b>H</b>	<b>SEAT DIMENSIONS</b>			<b>BACK DIMENSIONS</b>					
			72	31	30	63.5	19.5	17.5	63.5	12.5				
		<b>RTA 00</b>												

DESCRIPTION	FEATURES	MODEL#	STANDARD TEXTILE GRADES											
			1	2	3	4	5	6	7	8	9	10	11	12
 <p><b>Three Seat Sofa - Armless</b> COM Yardage: 7.25 Freight Class: 250 Product Weight (lbs.): 115 Cubic Feet Per Carton: 50.25</p>		<b>7897</b>	-	-	-	-	1747	1891	2168	2662	2945	3403	4095	4922
		<b>7897LF</b> Leather/Fabric	-	-	-	-	2632	2775	3051	3546	3830	4287	4980	5807
		<b>OVERALL DIMENSIONS</b>	<b>W</b>	<b>D</b>	<b>H</b>	<b>SEAT DIMENSIONS</b>			<b>BACK DIMENSIONS</b>					
			63.5	31	30.75	63.5	19.5	17.5	63.5	12.5				
		<b>RTA 00</b>												

DESCRIPTION	FEATURES	MODEL#	STANDARD TEXTILE GRADES											
			1	2	3	4	5	6	7	8	9	10	11	12
 <p><b>Ottoman</b> COM Yardage: 1.50 Freight Class: 250 Product Weight (lbs.): 27 Cubic Feet Per Carton: 7.50</p>			-	-	-	-	411	442	501	609	670	772	921	1100
			-	-	-	-	520	551	612	718	779	879	1029	1210
			Leather/Fabric	<b>OVERALL DIMENSIONS</b>			<b>SEAT DIMENSIONS</b>			<b>BACK DIMENSIONS</b>				
			<b>W</b>	<b>D</b>	<b>H</b>	<b>W</b>	<b>D</b>	<b>H</b>	<b>W</b>	<b>H</b>				
			22	22	17	-	-	17	-	-				
			<b>RTA 00</b>											

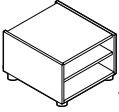
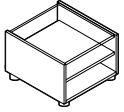
DESCRIPTION	FEATURES	MODEL#	STANDARD TEXTILE GRADES											
			1	2	3	4	5	6	7	8	9	10	11	12
  <p><b>End Table</b> COM Yardage: N/A Freight Class: 100 Product Weight (lbs.): 53 Cubic Feet Per Carton: 6</p>			580	-	-	-	-	-	-	-	-	-	-	-
			819	-	-	-	-	-	-	-	-	-	-	-
			Glass Top	<b>OVERALL DIMENSIONS</b>			<b>SEAT DIMENSIONS</b>			<b>BACK DIMENSIONS</b>				
			<b>W</b>	<b>D</b>	<b>H</b>	<b>W</b>	<b>D</b>	<b>H</b>	<b>W</b>	<b>H</b>				
			20	24	20	-	-	-	-	-				
			<b>RTA 1</b>											

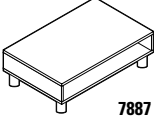
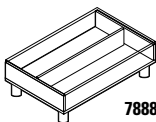
DESCRIPTION	FEATURES	MODEL#	STANDARD TEXTILE GRADES											
			1	2	3	4	5	6	7	8	9	10	11	12
  <p><b>Coffee Table</b> Rectangular COM Yardage: N/A Freight Class: 100 Product Weight (lbs.): 60 Cubic Feet Per Carton: 6.50</p>			605	-	-	-	-	-	-	-	-	-	-	-
			942	-	-	-	-	-	-	-	-	-	-	-
			Glass Top	<b>OVERALL DIMENSIONS</b>			<b>SEAT DIMENSIONS</b>			<b>BACK DIMENSIONS</b>				
			<b>W</b>	<b>D</b>	<b>H</b>	<b>W</b>	<b>D</b>	<b>H</b>	<b>W</b>	<b>H</b>				
			40	20	15	-	-	-	-	-				
			<b>RTA 1</b>											

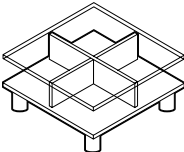
DESCRIPTION	FEATURES	MODEL#	STANDARD TEXTILE GRADES											
			1	2	3	4	5	6	7	8	9	10	11	12
 <p><b>Coffee Table</b> Square COM Yardage: N/A Freight Class: 92.5 Product Weight (lbs.): 90 Cubic Feet Per Carton: 8.75</p>			1144	-	-	-	-	-	-	-	-	-	-	-
			Glass Top	<b>OVERALL DIMENSIONS</b>			<b>SEAT DIMENSIONS</b>			<b>BACK DIMENSIONS</b>				
				<b>W</b>	<b>D</b>	<b>H</b>	<b>W</b>	<b>D</b>	<b>H</b>	<b>W</b>	<b>H</b>			
			33	33	15	-	-	-	-	-				
			<b>RTA 1</b>											

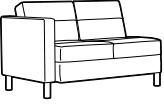
DESCRIPTION	FEATURES	MODEL#	STANDARD TEXTILE GRADES											
			1	2	3	4	5	6	7	8	9	10	11	12
  <p><b>Two Seat Sofa - No Connector</b> COM Yardage: 5.25 Freight Class: 250 Product Weight (lbs.): 91 Cubic Feet Per Carton: 36</p> <p style="text-align: center;">**Intended to be free standing. No connecting hardware.</p>			-	-	-	-	1499	1607	1817	2193	2408	2756	3283	3912
			-	-	-	-	1879	1987	2197	2574	2789	3137	3663	4293
			Leather/Fabric	<b>OVERALL DIMENSIONS</b>			<b>SEAT DIMENSIONS</b>			<b>BACK DIMENSIONS</b>				
			<b>W</b>	<b>D</b>	<b>H</b>	<b>W</b>	<b>D</b>	<b>H</b>	<b>W</b>	<b>H</b>				
			48	31	30.75	42.5	19.5	17.5	42.5	13.25				
			<b>RTA 00</b>											

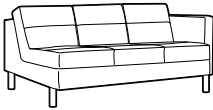

DESCRIPTION	FEATURES	MODEL#	STANDARD TEXTILE GRADES											
			1	2	3	4	5	6	7	8	9	10	11	12
 <p><b>7891LNB</b></p> <p><b>Three Seat Sofa - No Connector</b> COM Yardage: 7.25 Freight Class: 250 Product Weight (lbs.): 120 Cubic Feet Per Carton: 50.25</p>	<p><b>7891RNB</b></p> <p>**Intended to be free standing. No connecting hardware.</p>	7891LNB	-	-	-	-	2001	2144	2420	2915	3199	3656	4348	5175
		7891RNB												
		7891LFLNB	-	-	-	-	2584	2727	3003	3498	3782	4239	4931	5758
		7891LFRNB	Leather/Fabric											
			<b>OVERALL DIMENSIONS</b>			<b>SEAT DIMENSIONS</b>			<b>BACK DIMENSIONS</b>					
			<b>W</b>	<b>D</b>	<b>H</b>	<b>W</b>	<b>D</b>	<b>H</b>	<b>W</b>	<b>H</b>				
			70	31	30.75	63.5	19.5	17.5	63.5	13.25				
			<b>RTA 00</b>											

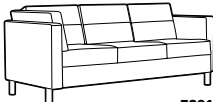
DESCRIPTION	FEATURES	MODEL#	STANDARD TEXTILE GRADES											
			1	2	3	4	5	6	7	8	9	10	11	12
 <p><b>7891L-RCNB</b></p> <p><b>Three Seat Sofa - No Connector</b> COM Yardage: 8.50 Freight Class: 250 Product Weight (lbs.): 140 Cubic Feet Per Carton: 55.50</p>	<p><b>7981R-LCNB</b></p> <p>**Intended to be free standing. No connecting hardware.</p>	7891L-RCNB	-	-	-	-	2412	2587	2927	3536	3886	4448	5302	6320
		7981R-LCNB												
		7891LFL-RCNB	-	-	-	-	3000	3176	3515	4125	4473	5037	5889	6908
		7891LFR-LCNB	Leather/Fabric											
			<b>OVERALL DIMENSIONS</b>			<b>SEAT DIMENSIONS</b>			<b>BACK DIMENSIONS</b>					
			<b>W</b>	<b>D</b>	<b>H</b>	<b>W</b>	<b>D</b>	<b>H</b>	<b>W</b>	<b>H</b>				
			77	31	30	60	19.5	17.5	60	13.25				
			<b>RTA 00</b>											

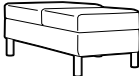
DESCRIPTION	FEATURES	MODEL#	STANDARD TEXTILE GRADES											
			1	2	3	4	5	6	7	8	9	10	11	12
 <p><b>Two Seat Bench</b> COM Yardage: 2.25 Freight Class: 250 Product Weight (lbs.): 42 Cubic Feet Per Carton: 11.50</p>		7893	-	-	-	-	818	865	954	1118	1209	1357	1582	1853
		7893LF	-	-	-	-	1023	1071	1159	1322	1414	1562	1789	2058
		Leather/Fabric												
					<b>OVERALL DIMENSIONS</b>			<b>SEAT DIMENSIONS</b>			<b>BACK DIMENSIONS</b>			
			<b>W</b>	<b>D</b>	<b>H</b>	<b>W</b>	<b>D</b>	<b>H</b>	<b>W</b>	<b>H</b>				
			43	21.5	17	-	-	17	-	-				
			<b>RTA 00</b>											

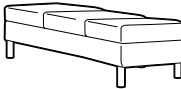
DESCRIPTION	FEATURES	MODEL#	STANDARD TEXTILE GRADES											
			1	2	3	4	5	6	7	8	9	10	11	12
 <p><b>Three Seat Bench</b> COM Yardage: 3.75 Freight Class: 250 Product Weight (lbs.): 62 Cubic Feet Per Carton: 16.75</p>		7894	-	-	-	-	1167	1246	1395	1663	1817	2068	2443	2891
		7894LF	-	-	-	-	1469	1547	1697	1966	2120	2369	2744	3193
		Leather/Fabric												
					<b>OVERALL DIMENSIONS</b>			<b>SEAT DIMENSIONS</b>			<b>BACK DIMENSIONS</b>			
			<b>W</b>	<b>D</b>	<b>H</b>	<b>W</b>	<b>D</b>	<b>H</b>	<b>W</b>	<b>H</b>				
			64.5	21.5	17	-	-	17	-	-				
			<b>RTA 00</b>											

CITI™ SQUARE



model S7875LFLT



Sample Layout A - Models shown: S7875FUC and S7911



Sample Layout B - Models shown: S7890RFUC, S7862FUC (2), S7897FUC, S7890LFUC and S7912.

STANDARD FEATURES

- Fully upholstered lounge series with a complete range of sectional components for all applications. Proportions are compact, 31" and 33.5" deep so it works well in public spaces.
- All models have fixed, non-removable cushions.
- Upholstered in leather or leather/mock leather combinations as standard. All leather models feature a horizontal stitch detail across the seat and back cushions.
- Standard models are upholstered in leather and leather/mock leather combination. Models with "LF" are upholstered in Genuine Italian leather or CTL Prescott leather and graded fabric choice for the balance of the seating unit. See note on "F" models, when all fabric or vinyl upholstery is required. Not available in Crescent fabric.
- The 5 inch high leg frame for seating and occasional tables lightens the look, it is available in Tungsten (S1) as standard or optionally available in Black (S2) Please specify finish, no upcharge added.
- Casters are not available on this series.
- Arm height on all models is 25"
- Tablet arms are made from thermally fused laminate, measure 12"D x 16.5"W 3/4" thick. Available right hand seated (RT), left Hand seated (LT) or both right and left hand (LRT).
- Ganging Brackets are sold separately. Ganging brackets are to be used on armless seating if interconnection to another armless seating unit is required. Bench and ottomans only gang to other benches/ottomans, cannot gang with seating units.
- Brackets come with a template for installation: unless noted otherwise all armless skus are equipped with the steel on steel connectors to receive this bracket.
- Measurement shown for weight is for one unit. Measurement for volume is per carton.

OPTIONAL FEATURES

- For high resilient, high density Ultracell foam on seat, PLEASE SPECIFY (UC) after the model number. One Seater, add \$99. Two Seater, add \$197. Three Seater, add \$295, and Four Seater, add \$393.
- Chrome finished leg frame on seating or tables Please Specify (S3) and add \$149.
- Upon request this series can alternatively be upholstered in Global Upholstery fabric or VINYL, add "F" to end of model number, for example S7885F, S7887FLT or 7890FR. Please use grade 5 price shown below for fabrics of a lower grade. (Note "F" models do not have horizontal decorative stitch detail across the middle of the seat and back cushions).
- To order units in combination of Global carded leathers on seat and back cushions and fabric on balance of chair see models where "LF" shows after first 4 digits.
- Tables and Tablet arms are made with high pressure laminate and are offered in the following finishes: Absolute Acajou (ACJ), Asian Night (ASN), Avant Cherry (AWC), Avant Honey (AWH), Black (BLK), Brushed Cobalt (BRC), Clear Maple (CMB), Dark Espresso (DES), Designer White (DWT), Hayden Grey (HGT), Quartered Mahogany (QTM), Tiger Fruitwood (TFW), Tiger Walnut (TWL), Walnut Heights (WHE), White Chocolate (WHC), Willow Grey (WGY) and Winter Cherry (WCR). Please Specify. Custom High Pressure laminate finishes will be considered upon request.
- Tablet arms are also offered in MDF with a tapered edge which features a rounded triangular profile and an epoxy finish. Available in Charcoal (CHR) or White (WHT). Please add \$202.
- Power/USB modules are available in the Citi Square tables. Each module includes a double power outlet and two USB terminals. It is equipped with a 6' long three-prong power cord with standard three prong plug. The Power monuments are available in Jet Black (J1) or White (W1). Add \$695 per unit. Please see Electrical Placement below for predetermined locations.

ELECTRICAL PLACEMENT

Coffee/End Tables: Predetermined Location is on the end/side of the unit J1 (black) or W1 (white).

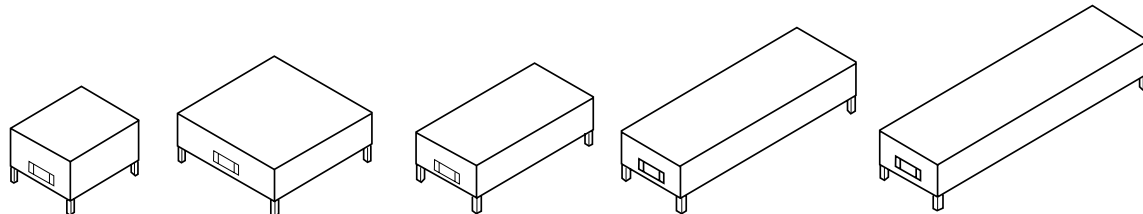

	1	2	3	4	5	6	7	8	9	10	11	12
7892	21	-	-	-	-	-	-	-	-	-	-	-





**Ganging Bracket**  
COM Yardage: N/A  
Freight Class: 70  
Product Weight (lbs.): 0.25  
Cubic Feet Per Carton: 0.01

Two brackets included.  
Only one set is needed per connection.

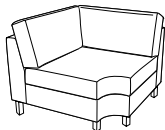
OVERALL DIMENSIONS			SEAT DIMENSIONS			BACK DIMENSIONS	
W	D	H	W	D	H	W	H
0.5	3.87	2	-	-	-	-	-

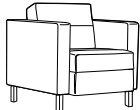
DESCRIPTION	FEATURES	MODEL#	STANDARD TEXTILE GRADES											
			1	2	3	4	5	6	7	8	9	10	11	12
 <p><b>Linking Corner Unit</b> COM Yardage: 6.25 Freight Class: 250 Product Weight (lbs.): 75 Cubic Feet Per Carton: 30.25</p>	No ganging hardware Armless side(s) can be equipped with ganging brackets, model 7892.	<b>S7862</b>	-	-	-	-	1818	1959	2226	2653	2980	3346	4099	4901
		<b>S7862LF</b>	-	-	-	-	2227	2365	2634	3061	3389	3755	4507	5309
		<b>OVERALL DIMENSIONS</b>			<b>SEAT DIMENSIONS</b>			<b>BACK DIMENSIONS</b>						
			<b>W</b>	<b>D</b>	<b>H</b>	<b>W</b>	<b>D</b>	<b>H</b>	<b>W</b>	<b>H</b>				
			37	37	30.75	26	26	17.5	26	13.5				
<b>RTA 00</b>														

DESCRIPTION	FEATURES	MODEL#	STANDARD TEXTILE GRADES											
			1	2	3	4	5	6	7	8	9	10	11	12
 <p><b>Single Seat w/Arms</b> COM Yardage: 4.50 Freight Class: 250 Product Weight (lbs.): 66 Cubic Feet Per Carton: 21</p>	Free standing unit only.	<b>S7875</b>	-	-	-	-	1284	1385	1577	1884	2121	2384	2926	3504
		<b>S7875LF</b>	-	-	-	-	1469	1570	1763	2070	2306	2570	3111	3689
		<b>OVERALL DIMENSIONS</b>			<b>SEAT DIMENSIONS</b>			<b>BACK DIMENSIONS</b>						
			<b>W</b>	<b>D</b>	<b>H</b>	<b>W</b>	<b>D</b>	<b>H</b>	<b>W</b>	<b>H</b>				
			30	31	30	21	19.5	17.5	21	12.5				
<b>RTA 00</b>														

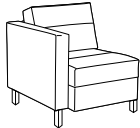

DESCRIPTION	FEATURES	MODEL#	STANDARD TEXTILE GRADES											
			1	2	3	4	5	6	7	8	9	10	11	12
 <p><b>S7875RT</b></p>	Free standing unit only. Tablets are Right Hand Seated (RT) or Left Hand Seated (LT).	<b>S7875RT</b>	-	-	-	-	1720	1819	2013	2320	2556	2820	3361	3939
		<b>S7875LT</b>	-	-	-	-	1720	1819	2013	2320	2556	2820	3361	3939
		<b>S7875LFRT</b>	-	-	-	-	1904	2005	2197	2504	2741	3005	3546	4124
<b>S7875LFLT</b>	-	-	-	-	1904	2005	2197	2504	2741	3005	3546	4124		
<b>OVERALL DIMENSIONS</b>			<b>SEAT DIMENSIONS</b>			<b>BACK DIMENSIONS</b>								
			<b>W</b>	<b>D</b>	<b>H</b>	<b>W</b>	<b>D</b>	<b>H</b>	<b>W</b>	<b>H</b>				
			31	33.5	30	21	19.5	17.5	21	12.5				
<b>RTA 00</b>														

DESCRIPTION	FEATURES	MODEL#	STANDARD TEXTILE GRADES											
			1	2	3	4	5	6	7	8	9	10	11	12
 <p><b>S7901R</b></p>	No ganging hardware. Armless side can be equipped with ganging brackets, model 7892. Arms are Right Hand Seated (RT) or Left Hand Seated (LT).	<b>S7901R</b>	-	-	-	-	1284	1362	1513	1751	1935	2140	2561	3010
		<b>S7901L</b>	-	-	-	-	1284	1362	1513	1751	1935	2140	2561	3010
		<b>S7901LFR</b>	-	-	-	-	1469	1559	1731	2004	2213	2448	2929	3443
<b>S7901LFL</b>	-	-	-	-	1469	1559	1731	2004	2213	2448	2929	3443		
<b>OVERALL DIMENSIONS</b>			<b>SEAT DIMENSIONS</b>			<b>BACK DIMENSIONS</b>								
			<b>W</b>	<b>D</b>	<b>H</b>	<b>W</b>	<b>D</b>	<b>H</b>	<b>W</b>	<b>H</b>				
			25.5	31	30.75	21	19.5	17.5	21	12.5				
<b>RTA 00</b>														

DESCRIPTION	FEATURES	MODEL#	STANDARD TEXTILE GRADES											
			1	2	3	4	5	6	7	8	9	10	11	12
 <p><b>S7901RR</b></p>	No ganging hardware. Armless side(s) can be equipped with ganging brackets, model 7892. Tablets are Arms are Right Hand Seated (RT) or Left Hand Seated (LT).	<b>S7901RR</b>	-	-	-	-	1720	1947	1783	2187	2371	2575	2997	3446
		<b>S7901LLT</b>	-	-	-	-	1720	1798	1947	2187	2371	2575	2997	3446
		<b>S7901LFRRT</b>	-	-	-	-	1904	1994	2165	2437	2648	2882	3363	3876
<b>S7901LFLRT</b>	-	-	-	-	1904	1994	2165	2437	2648	2882	3363	3876		
<b>OVERALL DIMENSIONS</b>			<b>SEAT DIMENSIONS</b>			<b>BACK DIMENSIONS</b>								
			<b>W</b>	<b>D</b>	<b>H</b>	<b>W</b>	<b>D</b>	<b>H</b>	<b>W</b>	<b>H</b>				
			27.5	31	30.75	21	19.5	17.5	21	12.5				
<b>RTA 00</b>														

# LOUNGE

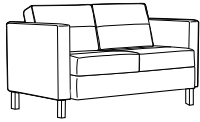
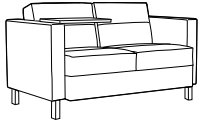
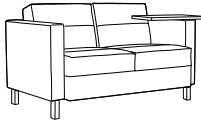
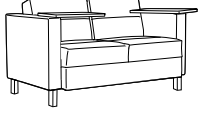
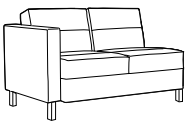
# CITI™ SQUARE C

DESCRIPTION	FEATURES	MODEL#	STANDARD TEXTILE GRADES											
			1	2	3	4	5	6	7	8	9	10	11	12
 <p><b>Armless Single Seat</b> COM Yardage: 3 Freight Class: 250 Product Weight (lbs.): 40 Cubic Feet Per Carton: 15.50</p>	<p>No ganging hardware. Armless side(s) can be equipped with ganging brackets, model 7892.</p>													
		<b>S7895</b>	-	-	-	-	1284	1352	1480	1685	1842	2017	2379	2763
		<b>S7895LF</b>	-	-	-	-	1469	1536	1665	1870	2028	2204	2563	2948
		<b>OVERALL DIMENSIONS</b>			<b>SEAT DIMENSIONS</b>			<b>BACK DIMENSIONS</b>						
		<b>W</b>	<b>D</b>	<b>H</b>	<b>W</b>	<b>D</b>	<b>H</b>	<b>W</b>	<b>H</b>					
		21	31	30.75	21	18.5	17.5	21	12.5					
			<b>RTA 00</b>											
 <p><b>Two Seater w/Arms</b> COM Yardage: 6.25 Freight Class: 250 Product Weight (lbs.): 108 Cubic Feet Per Carton: 36</p>	<p>Free standing unit only.</p>													
		<b>S7876</b>	-	-	-	-	1818	1959	2226	2653	2980	3346	4099	4901
		<b>S7876LF</b>	-	-	-	-	2227	2365	2634	3061	3389	3755	4507	5309
		<b>OVERALL DIMENSIONS</b>			<b>SEAT DIMENSIONS</b>			<b>BACK DIMENSIONS</b>						
		<b>W</b>	<b>D</b>	<b>H</b>	<b>W</b>	<b>D</b>	<b>H</b>	<b>W</b>	<b>H</b>					
		50.5	31	30	42.5	19.5	17.5	42.5	12.5					
			<b>RTA 00</b>											
 <p><b>S7876RT</b></p>	 <p><b>S7876LT</b></p>													
		<b>S7876RT</b>	-	-	-	-	2254	2393	2662	3087	3416	3782	4535	5337
		<b>S7876LT</b>	-	-	-	-	2254	2393	2662	3087	3416	3782	4535	5337
		<b>S7876LFRT</b>	-	-	-	-	2663	2802	3070	3497	3825	4191	4942	5745
<b>S7876LFLT</b>	-	-	-	-	2663	2802	3070	3497	3825	4191	4942	5745		
<b>OVERALL DIMENSIONS</b>			<b>SEAT DIMENSIONS</b>			<b>BACK DIMENSIONS</b>								
		<b>W</b>	<b>D</b>	<b>H</b>	<b>W</b>	<b>D</b>	<b>H</b>	<b>W</b>	<b>H</b>					
		51.5	33.5	30	42.5	19.5	17.5	42.5	12.5					
			<b>RTA 00</b>											
 <p><b>Two Seater w/Arms &amp; Laminate Tablets</b> COM Yardage: 6.25 Freight Class: 250 Product Weight (lbs.): 125 Cubic Feet Per Carton: 41.25</p>	<p>Free standing unit only. With both Left and Right Tablets.</p>													
		<b>S7876LRT</b>	-	-	-	-	2690	2829	3098	3523	3852	4217	4970	5773
		<b>S7876LFLT</b>	-	-	-	-	3099	3237	3506	3931	4261	4626	5378	6180
		<b>OVERALL DIMENSIONS</b>			<b>SEAT DIMENSIONS</b>			<b>BACK DIMENSIONS</b>						
		<b>W</b>	<b>D</b>	<b>H</b>	<b>W</b>	<b>D</b>	<b>H</b>	<b>W</b>	<b>H</b>					
		53.5	33.5	30	42.5	19.5	17.5	42.5	12.5					
			<b>RTA 00</b>											
 <p><b>S7890R</b></p>	 <p><b>S7890L</b></p>													
		<b>S7890R</b>	-	-	-	-	1688	1805	2030	2388	2664	2972	3602	4278
		<b>S7890L</b>	-	-	-	-	1688	1805	2030	2388	2664	2972	3602	4278
		<b>S7890LFR</b>	-	-	-	-	2097	2213	2437	2796	3072	3379	4011	4685
<b>S7890LFL</b>	-	-	-	-	2097	2213	2437	2796	3072	3379	4011	4685		
<b>OVERALL DIMENSIONS</b>			<b>SEAT DIMENSIONS</b>			<b>BACK DIMENSIONS</b>								
		<b>W</b>	<b>D</b>	<b>H</b>	<b>W</b>	<b>D</b>	<b>H</b>	<b>W</b>	<b>H</b>					
		48	31	30.75	42.5	19.5	17.5	42.5	13.25					
			<b>RTA 00</b>											

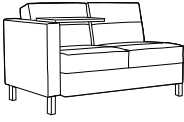
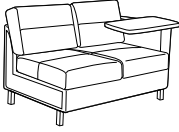
DESCRIPTION	FEATURES	MODEL#	STANDARD TEXTILE GRADES											
			1	2	3	4	5	6	7	8	9	10	11	12
 <p><b>S7890RRT</b></p> <p><b>Two Seater w/One Arm and Laminate Tablet</b> COM Yardage: 5.25 Freight Class: 250 Product Weight (lbs.): 115 Cubic Feet Per Carton: 41.25</p>	 <p><b>S7890LLT</b></p> <p>No ganging hardware. Armless side(s) can be equipped with ganging brackets, model 7892. Tablets are Arms are Right Hand Seated (RT) or Left Hand Seated (LT).</p>													
<b>OVERALL DIMENSIONS</b>			<b>SEAT DIMENSIONS</b>			<b>BACK DIMENSIONS</b>								
<b>W D H</b>			<b>W D H</b>			<b>W H</b>								
49 33.5 30.75			42.5 19.5 17.5			42.5 13.25								
<b>RTA 00</b>														

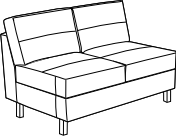
DESCRIPTION	FEATURES	MODEL#	STANDARD TEXTILE GRADES											
			1	2	3	4	5	6	7	8	9	10	11	12
 <p><b>S7896</b></p> <p><b>Armless Two Seater</b> COM Yardage: 5 Freight Class: 250 Product Weight (lbs.): 42.5 Cubic Feet Per Carton: 36</p>	<p>No ganging hardware. Armless side(s) can be equipped with ganging brackets, model 7892.</p>													
<b>OVERALL DIMENSIONS</b>			<b>SEAT DIMENSIONS</b>			<b>BACK DIMENSIONS</b>								
<b>W D H</b>			<b>W D H</b>			<b>W H</b>								
42.5 31 30.75			42.5 19.5 17.5			42.5 13.25								
<b>RTA 00</b>														

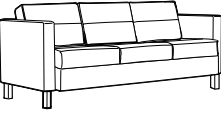
DESCRIPTION	FEATURES	MODEL#	STANDARD TEXTILE GRADES											
			1	2	3	4	5	6	7	8	9	10	11	12
 <p><b>S7877</b></p> <p><b>Three Seater w/Arms</b> COM Yardage: 8.75 Freight Class: 250 Product Weight (lbs.): 149 Cubic Feet Per Carton: 5</p>	<p>Free standing unit only.</p>													
<b>OVERALL DIMENSIONS</b>			<b>SEAT DIMENSIONS</b>			<b>BACK DIMENSIONS</b>								
<b>W D H</b>			<b>W D H</b>			<b>W H</b>								
72 31 30			63.5 19.5 17.5			63.5 12.5								
<b>RTA 00</b>														

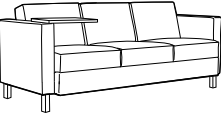
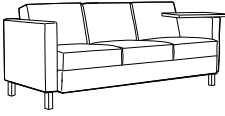
DESCRIPTION	FEATURES	MODEL#	STANDARD TEXTILE GRADES											
			1	2	3	4	5	6	7	8	9	10	11	12
 <p><b>S7877RT</b></p> <p><b>Three Seater w/Arms and Laminate Tablet</b> COM Yardage: 8.75 Freight Class: 250 Product Weight (lbs.): 146 Cubic Feet Per Carton: 55.50</p>	 <p><b>S7877LT</b></p> <p>Free standing unit only. Tablets are Right Hand Seated (RT) or Left Hand Seated (LT).</p>													
<b>OVERALL DIMENSIONS</b>			<b>SEAT DIMENSIONS</b>			<b>BACK DIMENSIONS</b>								
<b>W D H</b>			<b>W D H</b>			<b>W H</b>								
73 33.5 30			63.5 19.5 17.5			63.5 12.5								
<b>RTA 00</b>														

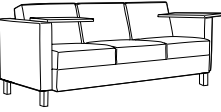
DESCRIPTION	FEATURES	MODEL#	STANDARD TEXTILE GRADES											
			1	2	3	4	5	6	7	8	9	10	11	12
 <p><b>S7877LRT</b></p> <p><b>Three Seater w/Arms and Laminate Tablets</b> COM Yardage: 8.75 Freight Class: 250 Product Weight (lbs.): 250 Cubic Feet Per Carton: 55.50</p>	<p>Free standing unit only. With both Left and Right Tablets.</p>													
<b>OVERALL DIMENSIONS</b>			<b>SEAT DIMENSIONS</b>			<b>BACK DIMENSIONS</b>								
<b>W D H</b>			<b>W D H</b>			<b>W H</b>								
75 33.5 30			63.5 19.5 17.5			63.5 12.5								
<b>RTA 00</b>														

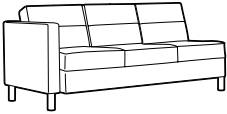
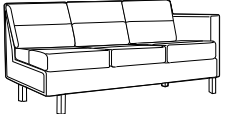
DESCRIPTION	FEATURES	MODEL#	STANDARD TEXTILE GRADES											
			1	2	3	4	5	6	7	8	9	10	11	12
 <p><b>S7891R</b></p>	 <p><b>S7891L</b></p>		-	-	-	-	2280	2442	2753	3247	3628	4051	4924	5855
			-	-	-	-	2280	2442	2753	3247	3628	4051	4924	5855
<p><b>Three Seater w/One Arm</b> COM Yardage: 7.25 Freight Class: 250 Product Weight (lbs.): 120 Cubic Feet Per Carton: 50.25</p>			<p>No ganging hardware. Armless side can be equipped with ganging brackets, model 7892. Arms are Right Hand Seated (RT) or Left Hand Seated (LT) .</p>											
			<p><b>OVERALL DIMENSIONS</b></p> <p>W D H</p>			<p><b>SEAT DIMENSIONS</b></p> <p>W D H</p>			<p><b>BACK DIMENSIONS</b></p> <p>W H</p>					
			70 31 30.75			63.5 19.5 17.5			63.5 13.25					
<b>RTA 00</b>														

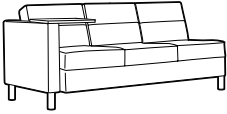
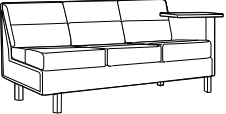
DESCRIPTION	FEATURES	MODEL#	STANDARD TEXTILE GRADES											
			1	2	3	4	5	6	7	8	9	10	11	12
 <p><b>S7891RRR</b></p>	 <p><b>S7891LLT</b></p>		-	-	-	-	2715	2875	3186	3682	4063	4486	5359	6290
			-	-	-	-	2715	2875	3186	3682	4063	4486	5359	6290
<p><b>Three Seater w/One Arm and Laminate Tablet</b> COM Yardage: 7.25 Freight Class: 250 Product Weight (lbs.): 146 Cubic Feet Per Carton: 55.50</p>			<p>No ganging hardware. Armless side(s) can be equipped with ganging brackets, model 7892. Tablets are Arms are Right Hand Seated (RT) or Left Hand Seated (LT).</p>											
			<p><b>OVERALL DIMENSIONS</b></p> <p>W D H</p>			<p><b>SEAT DIMENSIONS</b></p> <p>W D H</p>			<p><b>BACK DIMENSIONS</b></p> <p>W H</p>					
			73 33.5 30.75			63.5 19.5 17.5			63.5 13.25					
<b>RTA 00</b>														

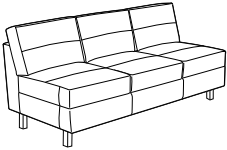
DESCRIPTION	FEATURES	MODEL#	STANDARD TEXTILE GRADES											
			1	2	3	4	5	6	7	8	9	10	11	12
 <p><b>S7897</b></p>			-	-	-	-	2280	2442	2753	3247	3628	4051	4924	5855
			-	-	-	-	2280	2442	2753	3247	3628	4051	4924	5855
<p><b>Armless Three Seater</b> COM Yardage: 7.25 Freight Class: 250 Product Weight (lbs.): 115 Cubic Feet Per Carton: 50.25</p>			<p>No ganging hardware. Armless side(s) can be equipped with ganging brackets, model 7892.</p>											
			<p><b>OVERALL DIMENSIONS</b></p> <p>W D H</p>			<p><b>SEAT DIMENSIONS</b></p> <p>W D H</p>			<p><b>BACK DIMENSIONS</b></p> <p>W H</p>					
			63.5 31 30.75			63.5 19.5 17.5			63.5 13.25					
<b>RTA 00</b>														

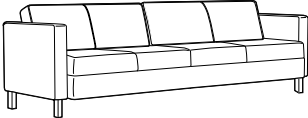
DESCRIPTION	FEATURES	MODEL#	STANDARD TEXTILE GRADES											
			1	2	3	4	5	6	7	8	9	10	11	12
 <p><b>S7884</b></p>			-	-	-	-	3463	3691	4130	4830	5368	5967	7201	8519
			-	-	-	-	3463	3691	4130	4830	5368	5967	7201	8519
<p><b>Four Seater w/Arms</b> COM Yardage: 10.25 Freight Class: 250 Product Weight (lbs.): 185 Cubic Feet Per Carton: 69</p>			<p>Free standing unit only.</p>											
			<p><b>OVERALL DIMENSIONS</b></p> <p>W D H</p>			<p><b>SEAT DIMENSIONS</b></p> <p>W D H</p>			<p><b>BACK DIMENSIONS</b></p> <p>W H</p>					
			93.5 31 30			84 19.5 17.5			84 12.5					
<b>RTA 00</b>														

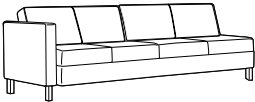
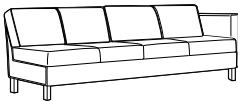
DESCRIPTION	FEATURES	MODEL#	STANDARD TEXTILE GRADES											
			1	2	3	4	5	6	7	8	9	10	11	12
 <p><b>S7884R</b></p>	 <p><b>S7884L</b></p>		-	-	-	-	3389	3600	4008	4655	5156	5711	6854	8074
			-	-	-	-	3389	3600	4008	4655	5156	5711	6854	8074
<p><b>Four Seater w/One Arm</b> COM Yardage: 9.50 Freight Class: 250 Product Weight (lbs.): 165 Cubic Feet Per Carton: 69</p>			<p>No ganging hardware. Armless side can be equipped with ganging brackets, model 7892. Arms are Right Hand Seated (RT) or Left Hand Seated (LT) .</p>											
			<p><b>OVERALL DIMENSIONS</b></p> <p>W D H</p>			<p><b>SEAT DIMENSIONS</b></p> <p>W D H</p>			<p><b>BACK DIMENSIONS</b></p> <p>W H</p>					
			88 31 30.75			84 19.5 17.5			84 12.5					
<b>RTA 00</b>														

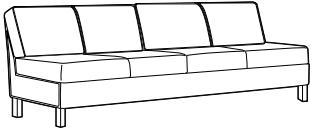
DESCRIPTION	FEATURES	MODEL#	STANDARD TEXTILE GRADES											
			1	2	3	4	5	6	7	8	9	10	11	12
 <p><b>Armless Four Seater</b> COM Yardage: 8.75 Freight Class: 250 Product Weight (lbs.): 155 Cubic Feet Per Carton: 61.50</p>	<p>No ganging hardware. Armless side(s) can be equipped with ganging brackets, model 7892.</p>	<b>S7884NA</b>	-	-	-	-	3389	3583	3959	4556	5016	5527	6580	7704
		<b>S7884LFNA</b>	-	-	-	-	4269	4463	4838	5436	5895	6408	7460	8583
		<b>OVERALL DIMENSIONS</b>			<b>SEAT DIMENSIONS</b>			<b>BACK DIMENSIONS</b>						
			<b>W</b>	<b>D</b>	<b>H</b>	<b>W</b>	<b>D</b>	<b>H</b>	<b>W</b>	<b>D</b>	<b>H</b>	<b>W</b>	<b>H</b>	
			85.5	31	30.75	84	19.5	17.5	84		12.5			
			<b>RTA 00</b>											

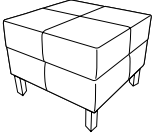
DESCRIPTION	FEATURES	MODEL#	STANDARD TEXTILE GRADES											
			1	2	3	4	5	6	7	8	9	10	11	12
 <p><b>Square Ottoman</b> COM Yardage: 1.50 Freight Class: 250 Product Weight (lbs.): 27 Cubic Feet Per Carton: 7.50</p>	<p>No ganging hardware. Side(s) can be equipped with ganging brackets, model 7892. Does not gang to seating units.</p>	<b>S7879</b>	-	-	-	-	532	566	630	733	811	899	1080	1272
		<b>S7879LF</b>	-	-	-	-	642	676	740	843	921	1009	1190	1382
		<b>OVERALL DIMENSIONS</b>			<b>SEAT DIMENSIONS</b>			<b>BACK DIMENSIONS</b>						
			<b>W</b>	<b>D</b>	<b>H</b>	<b>W</b>	<b>D</b>	<b>H</b>	<b>W</b>	<b>D</b>	<b>H</b>	<b>W</b>	<b>H</b>	
			22	22	17	-	-	17	-		-			
			<b>RTA 00</b>											

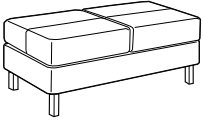
DESCRIPTION	FEATURES	MODEL#	STANDARD TEXTILE GRADES											
			1	2	3	4	5	6	7	8	9	10	11	12
 <p><b>Two Seater Bench</b> COM Yardage: 2.25 Freight Class: 250 Product Weight (lbs.): 42 Cubic Feet Per Carton: 11.50</p>	<p>No ganging hardware. Side(s) can be equipped with ganging brackets, model 7892. Does not gang to seating units.</p>	<b>S7893</b>	-	-	-	-	1024	1074	1172	1324	1444	1574	1845	2135
		<b>S7893LF</b>	-	-	-	-	1246	1296	1393	1545	1664	1796	2067	2356
		<b>OVERALL DIMENSIONS</b>			<b>SEAT DIMENSIONS</b>			<b>BACK DIMENSIONS</b>						
			<b>W</b>	<b>D</b>	<b>H</b>	<b>W</b>	<b>D</b>	<b>H</b>	<b>W</b>	<b>D</b>	<b>H</b>	<b>W</b>	<b>H</b>	
			43	21.5	17	-	-	17	-		-			
			<b>RTA 00</b>											

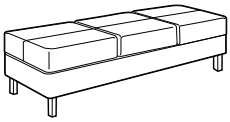
DESCRIPTION	FEATURES	MODEL#	STANDARD TEXTILE GRADES											
			1	2	3	4	5	6	7	8	9	10	11	12
 <p><b>Three Seater Bench</b> COM Yardage: 3.75 Freight Class: 250 Product Weight (lbs.): 62 Cubic Feet Per Carton: 16.75</p>	<p>No ganging hardware. Side(s) can be equipped with ganging brackets, model 7892. Does not gang to seating units.</p>	<b>S7894</b>	-	-	-	-	1458	1541	1702	1957	2155	2375	2826	3307
		<b>S7894LF</b>	-	-	-	-	1790	1873	2034	2289	2487	2706	3157	3638
		<b>OVERALL DIMENSIONS</b>			<b>SEAT DIMENSIONS</b>			<b>BACK DIMENSIONS</b>						
			<b>W</b>	<b>D</b>	<b>H</b>	<b>W</b>	<b>D</b>	<b>H</b>	<b>W</b>	<b>D</b>	<b>H</b>	<b>W</b>	<b>H</b>	
			64.5	21.5	17	-	-	17	-		-			
			<b>RTA 00</b>											

DESCRIPTION	FEATURES	MODEL#	STANDARD TEXTILE GRADES											
			1	2	3	4	5	6	7	8	9	10	11	12
 <p><b>Two Seater Bench - Single Cushion</b> COM Yardage: 2.25 Freight Class: 250 Product Weight (lbs.): 42 Cubic Feet Per Carton: 11.50</p>	<p>No ganging hardware. Side(s) can be equipped with ganging brackets, model 7892. Does not gang to seating units.</p>	<b>S7905</b>	-	-	-	-	804	853	951	1104	1222	1354	1625	1914
		<b>S7905LF</b>	-	-	-	-	1025	1076	1172	1325	1444	1575	1846	2136
		<b>OVERALL DIMENSIONS</b>			<b>SEAT DIMENSIONS</b>			<b>BACK DIMENSIONS</b>						
			<b>W</b>	<b>D</b>	<b>H</b>	<b>W</b>	<b>D</b>	<b>H</b>	<b>W</b>	<b>D</b>	<b>H</b>	<b>W</b>	<b>H</b>	
			43	21.5	17	-	-	17	-		-			
			<b>RTA 00</b>											

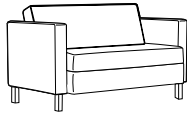
DESCRIPTION	FEATURES	MODEL#	STANDARD TEXTILE GRADES											
			1	2	3	4	5	6	7	8	9	10	11	12
	Free standing unit only.	<b>S7902</b>	-	-	-	-	1818	1959	2226	2653	2980	3346	4099	4901
		<b>S7902LF</b>	-	-	-	-	2227	2373	2651	3094	3436	3816	4598	5433
<b>OVERALL DIMENSIONS</b>			<b>SEAT DIMENSIONS</b>			<b>BACK DIMENSIONS</b>								
W D H			W D H			W H								
50.5 31 30			42.5 19.5 17.5			42.5 12.5								
<b>RTA 00</b>														

**Two Seater w/Arms - Single Cushion**  
 COM Yardage: 6.50  
 Freight Class: 250  
 Product Weight (lbs.): 108  
 Cubic Feet Per Carton: 36

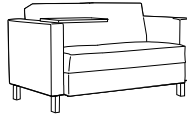
DESCRIPTION	FEATURES	MODEL#	STANDARD TEXTILE GRADES											
			1	2	3	4	5	6	7	8	9	10	11	12
	Free standing unit only. Tablets are Right Hand Seated (RT) or Left Hand Seated (LT).	<b>S7902RT</b>	-	-	-	-	2254	1789	1789	3121	1789	3843	4626	5459
		<b>2254T</b>	-	-	-	-	2254	1789	1789	3121	1789	3843	4626	5459
<b>OVERALL DIMENSIONS</b>			<b>SEAT DIMENSIONS</b>			<b>BACK DIMENSIONS</b>								
W D H			W D H			W H								
51.5 33.5 30			42.5 19.5 17.5			42.5 13.25								
<b>RTA 00</b>														

**Two Seater w/Arms & Lam. Tablet - Single Cushion**  
 COM Yardage: 5.25  
 Freight Class: 250  
 Product Weight (lbs.): 115  
 Cubic Feet Per Carton: 36

DESCRIPTION	FEATURES	MODEL#	STANDARD TEXTILE GRADES											
			1	2	3	4	5	6	7	8	9	10	11	12
	Free standing unit only. With both Left and Right Tablets.	<b>S7902LRT</b>	-	-	-	-	2690	2834	3114	3557	3899	4279	5062	5895
		<b>S7902LFLRT</b>	-	-	-	-	3099	3244	3522	3965	4307	4687	5470	6304
<b>OVERALL DIMENSIONS</b>			<b>SEAT DIMENSIONS</b>			<b>BACK DIMENSIONS</b>								
W D H			W D H			W H								
53.5 33.5 30			42.5 19.5 17.5			42.5 12.5								
<b>RTA 00</b>														

**Two Seater w/Arms & Lam. Tablets - Single Cushion**  
 COM Yardage: 6.50  
 Freight Class: 250  
 Product Weight (lbs.): 125  
 Cubic Feet Per Carton: 41.25

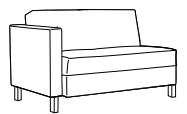
DESCRIPTION	FEATURES	MODEL#	STANDARD TEXTILE GRADES											
			1	2	3	4	5	6	7	8	9	10	11	12
	No ganging hardware. Armless side can be equipped with ganging brackets, model 7892. Arms are Right Hand Seated (RT) or Left Hand Seated (LT).	<b>S7902R</b>	-	-	-	-	1688	1805	2030	2388	2664	2972	3602	4278
		<b>S7902L</b>	-	-	-	-	1688	1805	2030	2388	2664	2972	3602	4278
<b>OVERALL DIMENSIONS</b>			<b>SEAT DIMENSIONS</b>			<b>BACK DIMENSIONS</b>								
W D H			W D H			W H								
48 31 30.75			42.5 19.5 17.5			42.5 13.25								
<b>RTA 00</b>														

**Two Seater w/One Arm - Single Cushion**  
 COM Yardage: 5.25  
 Freight Class: 250  
 Product Weight (lbs.): 91  
 Cubic Feet Per Carton: 36

DESCRIPTION	FEATURES	MODEL#	STANDARD TEXTILE GRADES											
			1	2	3	4	5	6	7	8	9	10	11	12
	Free standing unit only. Tablets are Right Hand Seated (RT) or Left Hand Seated (LT).	<b>S7902RRT</b>	-	-	-	-	2123	2241	2465	2824	3100	3407	4038	4712
		<b>2254T</b>	-	-	-	-	2123	2241	2465	2824	3100	3407	4038	4712
<b>OVERALL DIMENSIONS</b>			<b>SEAT DIMENSIONS</b>			<b>BACK DIMENSIONS</b>								
W D H			W D H			W H								
49 33.5 30.75			42.5 19.5 17.5			42.5 13.25								
<b>RTA 00</b>														

**Two Seater w/One Arm & Lam. Tablet - Single Cushion**  
 COM Yardage: 5.25  
 Freight Class: 250  
 Product Weight (lbs.): 115  
 Cubic Feet Per Carton: 36

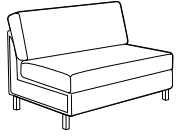

DESCRIPTION	FEATURES	MODEL#	STANDARD TEXTILE GRADES											
			1	2	3	4	5	6	7	8	9	10	11	12
 <b>Armless Two Seater - Single Cushion</b> COM Yardage: 4.50 Freight Class: 250 Product Weight (lbs.): 85 Cubic Feet Per Carton: 36	No ganging hardware. Armless side(s) can be equipped with ganging brackets, model 7892.													
		<b>S7902NA</b>	-	-	-	-	1688	1789	1981	2288	2525	2789	3329	3907
		<b>S7902LFNA</b>	-	-	-	-	2097	2196	2390	2697	2933	3197	3738	4316
			<b>OVERALL DIMENSIONS</b>			<b>SEAT DIMENSIONS</b>			<b>BACK DIMENSIONS</b>					
			<b>W</b>	<b>D</b>	<b>H</b>	<b>W</b>	<b>D</b>	<b>H</b>	<b>W</b>	<b>H</b>				
			42.5	31	30.75	42.5	19.5	17.5	42.5	13.25				
			<b>RTA 00</b>											

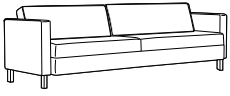
DESCRIPTION	FEATURES	MODEL#	STANDARD TEXTILE GRADES											
			1	2	3	4	5	6	7	8	9	10	11	12
 <b>Four Seater w/Arms - Duo Cushion</b> COM Yardage: 10.25 Freight Class: 250 Product Weight (lbs.): 185 Cubic Feet Per Carton: 69	Free standing unit only.													
		<b>S7904</b>	-	-	-	-	3463	3691	4130	4830	5368	5967	7201	8519
		<b>S7904LF</b>	-	-	-	-	4343	4572	5010	5710	6248	6848	8082	9397
			<b>OVERALL DIMENSIONS</b>			<b>SEAT DIMENSIONS</b>			<b>BACK DIMENSIONS</b>					
			<b>W</b>	<b>D</b>	<b>H</b>	<b>W</b>	<b>D</b>	<b>H</b>	<b>W</b>	<b>H</b>				
			93.5	31	30	84	19.5	17.5	84	12.5				
			<b>RTA 00</b>											

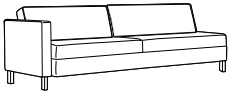
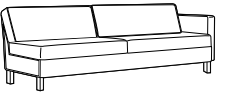
DESCRIPTION	FEATURES	MODEL#	STANDARD TEXTILE GRADES											
			1	2	3	4	5	6	7	8	9	10	11	12
  <b>Four Seater w/One Arm - Duo Cushion</b> COM Yardage: 9.50 Freight Class: 250 Product Weight (lbs.): 165 Cubic Feet Per Carton: 61.50	No ganging hardware. Armless side can be equipped with ganging brackets, model 7892. Arms are Right Hand Seated (RT) or Left Hand Seated (LT) .													
		<b>S7904R</b>	-	-	-	-	3389	3600	4008	4655	5156	5711	6854	8074
		<b>S7904L</b>	-	-	-	-	3389	3600	4008	4655	5156	5711	6854	8074
		<b>S7904LFR</b>	-	-	-	-	4269	4481	4888	5536	6035	6591	7734	8953
		<b>S7904LFL</b>	-	-	-	-	4269	4481	4888	5536	6035	6591	7734	8953
			<b>OVERALL DIMENSIONS</b>			<b>SEAT DIMENSIONS</b>			<b>BACK DIMENSIONS</b>					
			<b>W</b>	<b>D</b>	<b>H</b>	<b>W</b>	<b>D</b>	<b>H</b>	<b>W</b>	<b>H</b>				
			88	31	30.75	84	19.5	17.5	84	12.5				
			<b>RTA 00</b>											

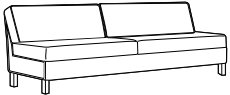
DESCRIPTION	FEATURES	MODEL#	STANDARD TEXTILE GRADES											
			1	2	3	4	5	6	7	8	9	10	11	12
 <b>Armless Four Seater - Single Cushion</b> COM Yardage: 8.75 Freight Class: 250 Product Weight (lbs.): 155 Cubic Feet Per Carton: 61.50	No ganging hardware. Armless side(s) can be equipped with ganging brackets, model 7892.													
		<b>S7904NA</b>	-	-	-	-	3389	3583	3959	4556	5016	5527	6580	7704
		<b>S7904LFNA</b>	-	-	-	-	4269	4463	4838	5436	5895	6408	7460	8583
			<b>OVERALL DIMENSIONS</b>			<b>SEAT DIMENSIONS</b>			<b>BACK DIMENSIONS</b>					
			<b>W</b>	<b>D</b>	<b>H</b>	<b>W</b>	<b>D</b>	<b>H</b>	<b>W</b>	<b>H</b>				
			85.5	31	30.75	84	19.5	17.5	84	12.5				
			<b>RTA 00</b>											

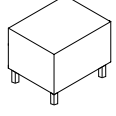
DESCRIPTION	FEATURES	MODEL#	STANDARD TEXTILE GRADES											
			1	2	3	4	5	6	7	8	9	10	11	12
 <b>Cube End Table</b> COM Yardage: N/A Freight Class: 100 Product Weight (lbs.): 51 Cubic Feet Per Carton: 5.50	Free standing unit only. No ganging hardware. For Power/USB module please see electrical placement chart.													
		<b>S7911</b>	1345	-	-	-	-	-	-	-	-	-	-	-
					<b>OVERALL DIMENSIONS</b>			<b>SEAT DIMENSIONS</b>			<b>BACK DIMENSIONS</b>			
			<b>W</b>	<b>D</b>	<b>H</b>	<b>W</b>	<b>D</b>	<b>H</b>	<b>W</b>	<b>H</b>				
			24	20	16	-	-	-	-	-				
			<b>RTA 00</b>											

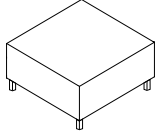
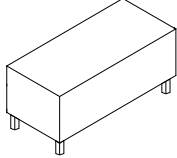
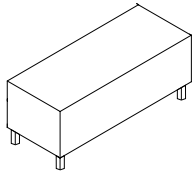
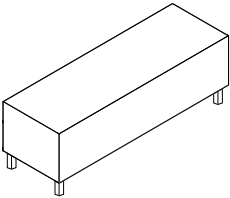
DESCRIPTION	FEATURES	MODEL#	STANDARD TEXTILE GRADES											
			1	2	3	4	5	6	7	8	9	10	11	12
 <p><b>Cube Square Coffee Table</b> COM Yardage: N/A Freight Class: 100 Product Weight (lbs.): 86 Cubic Feet Per Carton: 10.75</p>	<p>Free standing unit only. No ganging hardware. For Power/USB module please see electrical placement chart.</p>	<p><b>S7912</b> 1708</p>	-	-	-	-	-	-	-	-	-	-	-	
			<p><b>OVERALL DIMENSIONS</b></p>			<p><b>SEAT DIMENSIONS</b></p>			<p><b>BACK DIMENSIONS</b></p>					
			W	D	H	W	D	H	W	H				
			33	33	14	-	-	-	-	-				
			<p><b>RTA 00</b></p>											
 <p><b>Cube 40" Coffee Table</b> COM Yardage: N/A Freight Class: 100 Product Weight (lbs.): 66 Cubic Feet Per Carton: 8</p>	<p>Free standing unit only. No ganging hardware. For Power/USB module please see electrical placement chart.</p>	<p><b>S7913</b> 1618</p>	-	-	-	-	-	-	-	-	-	-		
			<p><b>OVERALL DIMENSIONS</b></p>			<p><b>SEAT DIMENSIONS</b></p>			<p><b>BACK DIMENSIONS</b></p>					
			W	D	H	W	D	H	W	H				
			40	20	14	-	-	-	-	-				
			<p><b>RTA 00</b></p>											
 <p><b>Cube Extended 60" Coffee Table</b> COM Yardage: N/A Freight Class: 125 Product Weight (lbs.): 93 Cubic Feet Per Carton: 12</p>	<p>Free standing unit only. No ganging hardware. For Power/USB module please see electrical placement chart.</p>	<p><b>S7915</b> 2114</p>	-	-	-	-	-	-	-	-	-	-		
			<p><b>OVERALL DIMENSIONS</b></p>			<p><b>SEAT DIMENSIONS</b></p>			<p><b>BACK DIMENSIONS</b></p>					
			W	D	H	W	D	H	W	H				
			60	20	14	-	-	-	-	-				
			<p><b>RTA 00</b></p>											
 <p><b>Cube Extended 72" Coffee Table</b> COM Yardage: N/A Freight Class: 125 Product Weight (lbs.): 107 Cubic Feet Per Carton: 14.25</p>	<p>Free standing unit only. No ganging hardware. For Power/USB module please see electrical placement chart.</p>	<p><b>S7916</b> 2162</p>	-	-	-	-	-	-	-	-	-	-		
			<p><b>OVERALL DIMENSIONS</b></p>			<p><b>SEAT DIMENSIONS</b></p>			<p><b>BACK DIMENSIONS</b></p>					
			W	D	H	W	D	H	W	H				
			72	20	14	-	-	-	-	-				
			<p><b>RTA 00</b></p>											

DAWSON TABLES



model 3374-G



model 3374-W

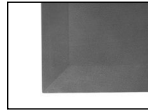

Glass Top (G)

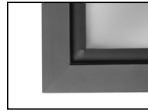

Wood Top (W)

STANDARD FEATURES

- Dawson tables feature elegant lines and details and were specifically created to offer a design-sensitive look that coordinates with the wood finishes and details of Global's lounge seating and desking.
- Tapered hardwood legs and edges
- Tops feature a sophisticated edge detail with frosted tempered safety glass or hardwood veneer inserts.
- Glass tops are 8 mm thick
- Tempered glass is lightly frosted on the bottom side of the top to create a slightly translucent look. The top side of the glass is not frosted to insure ease of cleaning.
- Shipped fully assembled.

OPTIONAL FEATURES

- Tables are available in Absolute (AAM), Black (BKM), Cherry (ACM), Espresso Cafe (ECM), English Oak (EOM), Fruitwood (TFM), Gray (HGM), Honey (AHM), Mahogany (TMM), Maple (AVM), Medium Walnut (MWM), Night (ASM), Shaker Cherry (SKM), Walnut (TWM), WC Cream (WTM), White (WHM) and Winter Cherry (WCM). Please Specify. Genuine maple faced veneers and solids are used.

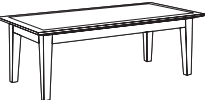
DESCRIPTION	FEATURES	MODEL#	STANDARD TEXTILE GRADES															
			1	2	3	4	5	6	7	8	9	10	11	12				
 <p><b>Square End Table</b> COM Yardage: N/A Freight Class: 150 Product Weight (lbs.): 27 Cubic Feet Per Carton: 6.75</p>		3374-G (Glass Top)	1098	-	-	-	-	-	-	-	-	-	-	-	-			
		3374-W (Wood Top)	1046	-	-	-	-	-	-	-	-	-	-	-	-			
		<b>OVERALL DIMENSIONS</b>			<b>SEAT DIMENSIONS</b>			<b>BACK DIMENSIONS</b>										
		<b>W</b>	<b>D</b>	<b>H</b>	<b>W</b>	<b>D</b>	<b>H</b>	<b>W</b>	<b>H</b>									
		22	22	17	-	-	-	-	-									
		<b>RTA 00</b>																
		 <p><b>Square End Table</b> COM Yardage: N/A Freight Class: 150 Product Weight (lbs.): 45 Cubic Feet Per Carton: 11</p>		3376-G (Glass Top)	1598	-	-	-	-	-	-	-	-	-	-	-	-	
				<b>OVERALL DIMENSIONS</b>			<b>SEAT DIMENSIONS</b>			<b>BACK DIMENSIONS</b>								
				<b>W</b>	<b>D</b>	<b>H</b>	<b>W</b>	<b>D</b>	<b>H</b>	<b>W</b>	<b>H</b>							
				21	42	15	-	-	-	-	-							
<b>RTA 00</b>																		

DRIFT



Chrome Base model 8034  
Low Back Lounge Chair



Wood Base model 8037  
Mid Back Lounge Chair



Wood Base model 8030  
Side Chair w/4 Leg



Ottoman model 8026



Chrome Base model 8041R26C  
Round Table w/4-Prong Base

STANDARD FEATURES

- The soft seat, contoured back and arms provide the perfect balance of style and comfort.
- Ottoman has a weighted bottom to maintain upright position.
- Side chair bases include: wood fixed, wood four prong swivel and metal four prong swivel.
- Lounge chair bases include: wood four prong swivel and metal four prong swivel.
- Wood bases are made from Beech and are available in all standard wood finishes.
- Metal four prong bases are only available in Polished Chrome.
- Upholstery options: fabric, vinyl, leather, or leather/mock leather combination. Ottoman model 8026 is not available in leather/mock leather combination.
- Tables are available in three shapes and three sizes each. All offer two base options; a 4-legged wood base or a polished chrome steel base.
- Table bases are fixed and do not swivel. Wood bases are made from Beech and are available in all standard wood finishes. Metal bases are available in Polished Chrome only.
- Table Tops are High Pressure Laminate.
- All models are equipped with White non-marking polycarbonate glides and suitable for concrete, rubber and carpeted floors.
- Not available in Silhouette fabric.

OPTIONAL FEATURES

- **Wood Bases**  
Wood Base Seating and Wood Table Bases are available **only** in the following Wood finishes:  

(AAM) Absolute	(BKM) Black
(ACM) Cherry	(EOM) English Oak
(ECM) Espresso Cafe	(TFM) Fruitwood
(HGM) Grey	(AHM) Honey
(TMM) Mahogany	(AVM) Maple
(MWM) Medium Walnut	
(ASM) Night	(SKM) Shaker Cherry
(TWM) Walnut	(WTM) WC Cream
(WHM) White	(WCM) Winter Cherry

 Please Specify.
- **Table Tops**  
Table Tops are available **only** in the following High Pressure Laminate finishes:  

(ACJ) Absolute Acajou	(ASN) Asian Night
(AWC) Avant Cherry	(AWH) Avant Honey
(BLK) Black	(BRC) Brushed Cobalt
(CMB) Clear Maple	(DES) Dark Espresso
(DWT) Designer White	(HGT) Hayden Grey
(QTM) Quartered Mahogany	
(SOG) Storm Grey	(TFW) Tiger Fruitwood
(TWL) Tiger Walnut	(WHE) Walnut Heights
(WHC) White Chocolate	
(WCR) Winter Cherry	(WGY) Willow Grey

 Please Specify.

EXAMPLE OF TABLE ORDER CODE:





8041R26W	ACJ	AAM
Model Number	Top HPL Finish	Base Finish - Wood Only

EXAMPLE OF CHAIR ORDER CODE:

8030	WA50	HGM
Model Number	Fabric	Legs

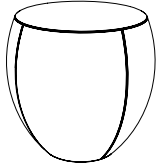
DRIFT TABLE FINISHES COORDINATION CHART			
HPL TOP FINISH		COORDINATING WOOD BASE FINISH	
ACJ**	Absolute Acajou	AAM	Absolute
ASN**	Asian Night	ASM	Night
AWC**	Avant Cherry	ACM	Cherry
AWH**	Avant Honey	AHM	Honey
BLK**	Black	BKM	Black
CMB**	Clear Maple	AVM*	Maple
DES**	Dark Espresso	ECM	Espresso Cafe
DWT**	Designer White	WHM	White
HGT**	Hayden Grey	HGM	Grey
QTM**	Quartered Mahogany	TMM	Mahogany
TFW**	Tiger Fruitwood	TFM	Fruitwood
TWL**	Tiger Walnut	TWM	Walnut
WCR**	Winter Cherry	WCM	Winter Cherry
WHC**	White Chocolate	WTM	WC Cream
WHE**	Walnut Heights	MWM	Medium Walnut
HPL TOP FINISHES WITH NO COORDINATING WOOD BASE FINISHES		WOOD BASE FINISHES WITH NO COORDINATING HPL TOP FINISHES	
BRC**	Brushed Cobalt	EOM	English Oak
SOG**	Storm Grey	SKM	Shaker Cherry
WGY**	Willow Grey	**Chrome base models are available for all HPL Top Finishes	

Please note that these finishes are coordinating and not exact matches. Please reach out to your Global Sales Representative for physical samples of finishes prior to ordering.

DESCRIPTION	FEATURES	MODEL#	STANDARD TEXTILE GRADES											
			1	2	3	4	5	6	7	8	9	10	11	12
 <p><b>Ottoman</b> COM Yardage: 1.75 Freight Class: 250 Product Weight (lbs.): 31 Cubic Feet Per Carton: 8.50</p>		<b>8026</b>	671	704	730	769	823	849	898	977	1038	1105	1244	1392
			<b>OVERALL DIMENSIONS</b>			<b>SEAT DIMENSIONS</b>			<b>BACK DIMENSIONS</b>					
			<b>W</b>	<b>D</b>	<b>H</b>	<b>W</b>	<b>D</b>	<b>H</b>	<b>W</b>	<b>H</b>				
			18.5	18.5	18	-	-	-	-	-				
			<b>RTA 00</b>		1 per carton									
 <p><b>Side Chair w/4 Leg Wood Base</b> COM Yardage: 2 Freight Class: 300 Product Weight (lbs.): 31 Cubic Feet Per Carton: 15.75</p>		<b>8030</b>	1139	1177	1206	1250	1313	1342	1398	1488	1558	1635	1794	1963
			<b>OVERALL DIMENSIONS</b>			<b>SEAT DIMENSIONS</b>			<b>BACK DIMENSIONS</b>					
			<b>W</b>	<b>D</b>	<b>H</b>	<b>W</b>	<b>D</b>	<b>H</b>	<b>W</b>	<b>H</b>				
			24.5	23	31	18	17.5	18	15	13				
			<b>RTA 00</b>		1 per carton									
 <p><b>Side Chair w/Wood Swivel Base</b> COM Yardage: 2 Freight Class: 300 Product Weight (lbs.): 31 Cubic Feet Per Carton: 15.75</p>		<b>8031</b>	1322	1391	1388	1432	1495	1524	1580	1670	1740	1817	1976	2145
			<b>OVERALL DIMENSIONS</b>			<b>SEAT DIMENSIONS</b>			<b>BACK DIMENSIONS</b>					
			<b>W</b>	<b>D</b>	<b>H</b>	<b>W</b>	<b>D</b>	<b>H</b>	<b>W</b>	<b>H</b>				
			24.5	23	31	18	17.5	18	15	13				
			<b>RTA 00</b>		1 per carton									
 <p><b>Side Chair w/Chrome Base</b> COM Yardage: 2 Freight Class: 300 Product Weight (lbs.): 31 Cubic Feet Per Carton: 15.75</p>		<b>8032</b>	1354	1391	1420	1464	1527	1556	1612	1702	1772	1849	2008	2177
			<b>OVERALL DIMENSIONS</b>			<b>SEAT DIMENSIONS</b>			<b>BACK DIMENSIONS</b>					
			<b>W</b>	<b>D</b>	<b>H</b>	<b>W</b>	<b>D</b>	<b>H</b>	<b>W</b>	<b>H</b>				
			24.5	23	31	18	17.5	18	15	13				
			<b>RTA 00</b>		1 per carton									
 <p><b>Low Back Lounge Chair w/Wood Swivel Base</b> COM Yardage: 3.25 Freight Class: 250 Product Weight (lbs.): 53 Cubic Feet Per Carton: 19</p>		<b>8033</b>	1945	2013	2066	2146	2259	2313	2415	2579	2705	2845	3134	3441
			<b>OVERALL DIMENSIONS</b>			<b>SEAT DIMENSIONS</b>			<b>BACK DIMENSIONS</b>					
			<b>W</b>	<b>D</b>	<b>H</b>	<b>W</b>	<b>D</b>	<b>H</b>	<b>W</b>	<b>H</b>				
			29	30	33	21.5	20	17	21	16				
			<b>RTA 00</b>		1 per carton									

DESCRIPTION	FEATURES	MODEL#	STANDARD TEXTILE GRADES												
			1	2	3	4	5	6	7	8	9	10	11	12	
		<b>8034</b>	1953	2020	2073	2153	2266	2319	2422	2586	2712	2852	3140	3448	
	<b>OVERALL DIMENSIONS</b>			<b>SEAT DIMENSIONS</b>			<b>BACK DIMENSIONS</b>								
	W D H			W D H			W H								
	29 30 33			21.5 20 17			21 16								
				<b>RTA 00</b>			1 per carton								

**Low Back Lounge Chair w/Chrome Base**  
 COM Yardage: 3.25  
 Freight Class: 250  
 Product Weight (lbs.): 59  
 Cubic Feet Per Carton: 19.25

DESCRIPTION	FEATURES	MODEL#	STANDARD TEXTILE GRADES												
			1	2	3	4	5	6	7	8	9	10	11	12	
		<b>8035</b>	2022	2091	2147	2229	2347	2402	2509	2678	2809	2954	3254	3573	
	<b>OVERALL DIMENSIONS</b>			<b>SEAT DIMENSIONS</b>			<b>BACK DIMENSIONS</b>								
	W D H			W D H			W H								
	29 31.5 38.5			21.5 20 17			21 21.5								
				<b>RTA 00</b>			1 per carton								

**Mid Back Lounge Chair w/Wood Swivel Base**  
 COM Yardage: 3.50  
 Freight Class: 250  
 Product Weight (lbs.): 54  
 Cubic Feet Per Carton: 25.50

DESCRIPTION	FEATURES	MODEL#	STANDARD TEXTILE GRADES												
			1	2	3	4	5	6	7	8	9	10	11	12	
		<b>8036</b>	2035	2106	2161	2244	2361	2416	2523	2692	2823	2968	3268	3587	
	<b>OVERALL DIMENSIONS</b>			<b>SEAT DIMENSIONS</b>			<b>BACK DIMENSIONS</b>								
	W D H			W D H			W H								
	29 31.5 38.5			21.5 20 17			21 21.5								
				<b>RTA 00</b>			1 per carton								

**Mid Back Lounge Chair w/Chrome Base**  
 COM Yardage: 3.50  
 Freight Class: 250  
 Product Weight (lbs.): 60  
 Cubic Feet Per Carton: 25.50

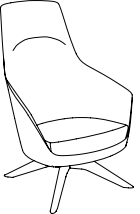
DESCRIPTION	FEATURES	MODEL#	STANDARD TEXTILE GRADES												
			1	2	3	4	5	6	7	8	9	10	11	12	
		<b>8037</b>	2210	2285	2345	2433	2559	2618	2732	2914	3054	3210	3531	3873	
	<b>OVERALL DIMENSIONS</b>			<b>SEAT DIMENSIONS</b>			<b>BACK DIMENSIONS</b>								
	W D H			W D H			W H								
	29 31.5 44.5			21.5 20 17			21 27.5								
				<b>RTA 00</b>			1 per carton								

**High Back Lounge Chair w/Wood Swivel Base**  
 COM Yardage: 3.75  
 Freight Class: 250  
 Product Weight (lbs.): 57  
 Cubic Feet Per Carton: 28.25

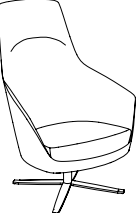
DESCRIPTION	FEATURES	MODEL#	STANDARD TEXTILE GRADES												
			1	2	3	4	5	6	7	8	9	10	11	12	
		<b>8038</b>	2223	2297	2356	2445	2571	2630	2744	2926	3066	3222	3542	3885	
	<b>OVERALL DIMENSIONS</b>			<b>SEAT DIMENSIONS</b>			<b>BACK DIMENSIONS</b>								
	W D H			W D H			W H								
	29 31.5 44.5			21.5 20 17			21 27.5								
				<b>RTA 00</b>			1 per carton								

**High Back Lounge Chair w/Chrome Base**  
 COM Yardage: 3.75  
 Freight Class: 250  
 Product Weight (lbs.): 63  
 Cubic Feet Per Carton: 28.25

**DESCRIPTION      MODEL #      DIMENSIONS      FREIGHT CLASS      WT/LB      CUBIC FT.      LIST PRICE**

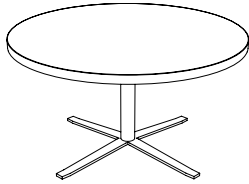

MODEL #	D x W x H	FREIGHT CLASS	WT/LBS	CUBIC FT	LIST PRICE
<b>8041R26C</b>	26 x 26 x 16	150	41	10.25	800
<b>8041R30C</b>	30 x 30 x 16	250	45	13	834
<b>8041R36C</b>	36 x 36 x 16	250	55	18	1047

Round Table w/Polished Chrome 4-Prong Base

**RTA 00**      1 per carton

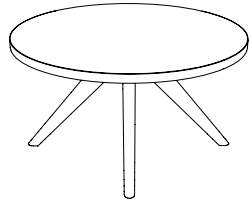

MODEL #	D x W x H	FREIGHT CLASS	WT/LBS	CUBIC FT	LIST PRICE
<b>8041R26W</b>	26 x 26 x 16	250	35	10.25	787
<b>8041R30W</b>	30 x 30 x 16	250	40	13	825
<b>8041R36W</b>	36 x 36 x 16	250	50	18	902

Round Table w/Wooden 4-Prong Base

**RTA 00**      1 per carton



MODEL #	D x W x H	FREIGHT CLASS	WT/LBS	CUBIC FT	LIST PRICE
<b>8042SQ22C</b>	22.75 x 22.75 x 16	150	39	7.75	800
<b>8042SQ28C</b>	28.5 x 28.5 x 16	150	47	11.50	834
<b>8042SQ34C</b>	34.5 x 34.5 x 16	250	58	16.25	1047

Square Table w/Radiused Corners + Polished Chrome 4-Prong Base

**RTA 00**      1 per carton

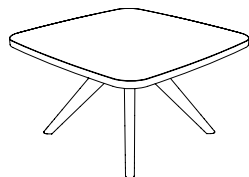

MODEL #	D x W x H	FREIGHT CLASS	WT/LBS	CUBIC FT	LIST PRICE
<b>8042SQ22W</b>	22.75 x 22.75 x 16	150	33	7.75	787
<b>8042SQ28W</b>	28.5 x 28.5 x 16	250	41	11.50	825
<b>8042SQ34W</b>	34.5 x 34.5 x 16	250	53	16.25	902

Square Table w/Radiused Corners + Wooden 4-Prong Base

**RTA 00**      1 per carton



MODEL #	D x W x H	FREIGHT CLASS	WT/LBS	CUBIC FT	LIST PRICE
<b>8043OV26C</b>	22 x 26 x 16	100	40	9	800
<b>8043OV31C</b>	26 x 31 x 16	250	45	11.75	834
<b>8043OV36C</b>	30 x 36 x 16	250	52	15.25	1047

Oval Table w/Polished Chrome 4-Prong Base

**RTA 00**      1 per carton

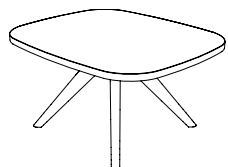

MODEL #	D x W x H	FREIGHT CLASS	WT/LBS	CUBIC FT	LIST PRICE
<b>8043OV26W</b>	22 x 26 x 16	250	34	9	787
<b>8043OV31W</b>	26 x 31 x 16	250	40	11.75	825
<b>8043OV36W</b>	30 x 36 x 16	250	47	15.25	902

Oval Table w/Wooden 4-Prong Base

**RTA 00**      1 per carton

JEO



model 8434



model 8433-4



Optional Quilted Stitch Back (Q).



Optional 5 prong base with glides (G).



model 8435-2224





model 8436-1530

STANDARD FEATURES



- JEO is a contemporary, retro - inspired series with versatility for a variety of workplace applications.
- The tailored box styling functions well in lounge, conferencing, collaboration and side/guest environments.
- Three seating models: swivel tilter with a 5 prong caster base, a swivel self-centering return with a stationary round pedestal base or a matching four legged Arm Chair.
- Model 8433-4 is standard with a five prong Black nylon base with carpet casters (C1).
- Model 8437 is standard with Black four-legged frame.
- JEO also offers two styles of matching pedestal base occasional tables with a round or square laminate top, available in two height sizes --- 15" and 22" high.
- Upholstery options: fabric, vinyl, leather or a combination of two or more materials. The upholstery surfaces are seamed together with tailored double stitch detailing.

OPTIONAL FEATURES

- Chairs are available with an Optional Quilted Stitch back. Please specify (Q). Add \$154.
- Model 8433-4 has an optional five prong Aluminum base. specify (AL). Add \$50.
- Optional 5 prong Aluminum base with hard glides. Please specify (C7).
- Optional soft casters are available on the 5 prong base. Please specify (C9R). Add \$51.
- Model 8434 round pedestal base available in Chrome (CH) or Brushed Chrome (BCH). Please specify.
- Model 8437 has optional Chrome (CH) or Brushed Chrome (BCH) four-legged frame.
- Occasional tables are available in the following laminate finishes to coordinate with Global Desking and wood seating: Absolute Acajou (ACJ), Asian Night (ASN), Avant Cherry (AWC), Avant Honey (AWH), Black (BLK), Brushed Cobalt (BRC), Clear Maple (CMB), Dark Espresso (DES), Designer White (DWT), Hayden Grey (HGT), Tiger Walnut (TWL), Tiger Fruitwood (TFW), Walnut Heights (WHE), White Chocolate (WHC), and Winter Cherry (WCR). Please Specify.

DESCRIPTION	FEATURES	MODEL#	STANDARD TEXTILE GRADES													
			1	2	3	4	5	6	7	8	9	10	11	12		
 <b>Self-Centering Lounge Chair on Pedestal Base</b> COM Yardage: 2.75 Freight Class: 250 Product Weight (lbs.): 50 Cubic Feet Per Carton: 22	Ergonomic Features: C	<b>8434</b>	1647	1712	1763	1840	1947	1987	2082	2263	2351	2519	2746	3032		
		<b>OVERALL DIMENSIONS</b>			<b>SEAT DIMENSIONS</b>			<b>BACK DIMENSIONS</b>								
		<b>W</b>	<b>D</b>	<b>H</b>	<b>W</b>	<b>D</b>	<b>H</b>	<b>W</b>	<b>H</b>							
			26	25	30-32.5	20	19	16.5-19	20	15						
 <b>Swivel Tilter Chair</b> COM Yardage: 2.75 Freight Class: 250 Product Weight (lbs.): 50 Cubic Feet Per Carton: 22	Ergonomic Features: A, B, C, S	<b>8433-4</b>	1118	1179	1228	1301	1405	1442	1534	1707	1791	1951	2171	2443		
		<b>OVERALL DIMENSIONS</b>			<b>SEAT DIMENSIONS</b>			<b>BACK DIMENSIONS</b>								
		<b>W</b>	<b>D</b>	<b>H</b>	<b>W</b>	<b>D</b>	<b>H</b>	<b>W</b>	<b>H</b>							
			26	25	30-32.5	20	19	16.5-19	20	15						
 <b>Arm Chair</b> COM Yardage: 2.75 Freight Class: 250 Product Weight (lbs.): 50 Cubic Feet Per Carton: 22		<b>8437</b>	1087	1158	1214	1297	1415	1470	1577	1747	1880	2027	2326	2648		
	<b>OVERALL DIMENSIONS</b>			<b>SEAT DIMENSIONS</b>			<b>BACK DIMENSIONS</b>									
	<b>W</b>	<b>D</b>	<b>H</b>	<b>W</b>	<b>D</b>	<b>H</b>	<b>W</b>	<b>H</b>								
			26	25	34	20	19	18	20	15						

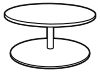
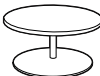

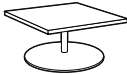
DESCRIPTION	FEATURES	MODEL#	STANDARD TEXTILE GRADES														
			1	2	3	4	5	6	7	8	9	10	11	12			
 <p><b>15" H Round End Table - 24" Dia. Top on Pedestal Base</b>                      COM Yardage: n/a                      Freight Class: 150                      Product Weight (lbs.): 44                      Cubic Feet Per Carton: 10</p>		<b>8435-1524</b>	1012														
				<b>OVERALL DIMENSIONS</b>			<b>SEAT DIMENSIONS</b>			<b>BACK DIMENSIONS</b>							
				<b>W</b>	<b>Dia.</b>	<b>H</b>	<b>W</b>	<b>D</b>	<b>H</b>	<b>W</b>	<b>H</b>						
				24	15												
 <p><b>15" H Round Coffee Table - 30" Dia. Top on Pedestal Base</b>                      COM Yardage: n/a                      Freight Class: 150                      Product Weight (lbs.): 44                      Cubic Feet Per Carton: 10</p>		<b>8435-1530</b>	1181														
				<b>OVERALL DIMENSIONS</b>			<b>SEAT DIMENSIONS</b>			<b>BACK DIMENSIONS</b>							
				<b>W</b>	<b>Dia.</b>	<b>H</b>	<b>W</b>	<b>D</b>	<b>H</b>	<b>W</b>	<b>H</b>						
				30	15												
 <p><b>22" H Round End Table - 24" Dia. Top on Pedestal Base</b>                      COM Yardage: n/a                      Freight Class: 150                      Product Weight (lbs.): 44                      Cubic Feet Per Carton: 10</p>		<b>8435-2224</b>	1109														
				<b>OVERALL DIMENSIONS</b>			<b>SEAT DIMENSIONS</b>			<b>BACK DIMENSIONS</b>							
				<b>W</b>	<b>Dia.</b>	<b>H</b>	<b>W</b>	<b>D</b>	<b>H</b>	<b>W</b>	<b>H</b>						
				24	22												
 <p><b>22" H Round Coffee Table - 30" Dia. Top on Pedestal Base</b>                      COM Yardage: n/a                      Freight Class: 150                      Product Weight (lbs.): 44                      Cubic Feet Per Carton: 10</p>		<b>8435-2230</b>	1278														
				<b>OVERALL DIMENSIONS</b>			<b>SEAT DIMENSIONS</b>			<b>BACK DIMENSIONS</b>							
				<b>W</b>	<b>Dia.</b>	<b>H</b>	<b>W</b>	<b>D</b>	<b>H</b>	<b>W</b>	<b>H</b>						
				30	22												
 <p><b>15" H Square End Table - 24" Top on Pedestal Base</b>                      COM Yardage: n/a                      Freight Class: 150                      Product Weight (lbs.): 44                      Cubic Feet Per Carton: 10</p>		<b>8436-1524</b>	1012														
				<b>OVERALL DIMENSIONS</b>			<b>SEAT DIMENSIONS</b>			<b>BACK DIMENSIONS</b>							
				<b>W</b>	<b>D</b>	<b>H</b>	<b>W</b>	<b>D</b>	<b>H</b>	<b>W</b>	<b>H</b>						
				24	24	15											

DESCRIPTION	FEATURES	MODEL#	STANDARD TEXTILE GRADES											
			1	2	3	4	5	6	7	8	9	10	11	12

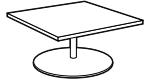

**15" H Square End Coffee - 30" Top on Pedestal Base**  
 COM Yardage: n/a  
 Freight Class: 150  
 Product Weight (lbs.): 44  
 Cubic Feet Per Carton: 10

8436-1530 1181

OVERALL DIMENSIONS			SEAT DIMENSIONS			BACK DIMENSIONS	
W	D	H	W	D	H	W	H
30	30	15					

1	2	3	4	5	6	7	8	9	10	11	12
8436-2224	1109										



**22" H Square End Table - 24" Top on Pedestal Base**  
 COM Yardage: n/a  
 Freight Class: 150  
 Product Weight (lbs.): 44  
 Cubic Feet Per Carton: 10

OVERALL DIMENSIONS			SEAT DIMENSIONS			BACK DIMENSIONS	
W	D	H	W	D	H	W	H
24	24	22					

1	2	3	4	5	6	7	8	9	10	11	12
8436-2230	1278										



**22" H Square End Coffee - 30" Top on Pedestal Base**  
 COM Yardage: n/a  
 Freight Class: 150  
 Product Weight (lbs.): 44  
 Cubic Feet Per Carton: 10

OVERALL DIMENSIONS			SEAT DIMENSIONS			BACK DIMENSIONS	
W	D	H	W	D	H	W	H
30	30	22					

KATE®



model 2811-4

model 2811-8

STANDARD FEATURES

- A contemporary, yet retro series featuring sculpted seat and back cushions.
- Fully upholstered closed arms offer a unique style and function in the workplace.
- Models are standard with a five legged Polished Aluminum base.
- **C10** casters are standard.



OPTIONAL FEATURES

- An optional Black injection molded base is available at no upcharge, please specify **(BK)**.
- There are no caster options for this series. **C7** glides can be specified at no upcharge.
- Available in grades 1-12, Fabric, Vinyl and Leather.
- For hard surface flooring please specify **C10R**. Add \$46.
- For fully assembled in box, please specify **SU**. Add \$55.

DESCRIPTION

FEATURES

MODEL#

STANDARD TEXTILE GRADES

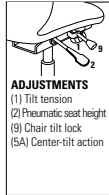

**MB Tilter**  
COM Yardage: 3.75  
Freight Class: 250  
Product Weight (lbs.): 45  
Cubic Feet Per Carton: 15.50

Ergonomic Features:  
A, B, C, N

	1	2	3	4	5	6	7	8	9	10	11	12
<b>2811-4</b>	991	1090	1172	1291	1463	1525	1673	1960	2098	2361	2722	3170
<b>2811LM-4</b>	-	-	-	-	1426	-	-	1922	2075	2324	2701	3151
Leather/Mock Leather												
OVERALL DIMENSIONS			SEAT DIMENSIONS			BACK DIMENSIONS						
W	D	H	W	D	H	W	H					
26	24.5	33	17.5	18	17.5-21.50	19	15.5					

RTA 00

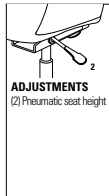

**MB Swivel**  
COM Yardage: 3.75  
Freight Class: 250  
Product Weight (lbs.): 41  
Cubic Feet Per Carton: 15.50

Ergonomic Features:  
C, N

	1	2	3	4	5	6	7	8	9	10	11	12
<b>2811-8</b>	957	1059	1140	1260	1431	1494	1643	1929	2066	2329	2690	3138
<b>2811LM-8</b>	-	-	-	-	1389	-	-	1885	2038	2288	2665	3112
Leather/Mock Leather												
OVERALL DIMENSIONS			SEAT DIMENSIONS			BACK DIMENSIONS						
W	D	H	W	D	H	W	H					
26	24.5	33	17.5	18	17.5-21.50	19	15.5					

RTA 00



**Armchair**  
COM Yardage: 3.75  
Freight Class: 250  
Product Weight (lbs.): 42  
Cubic Feet Per Carton: 15.50

Ergonomic Features:  
N

	1	2	3	4	5	6	7	8	9	10	11	12
<b>2813</b>	1083	1179	1256	1370	1534	1592	1735	2007	2138	2390	2732	3160
<b>2813LM</b>	-	-	-	-	1536	-	-	2010	-	2392	2752	3178
Leather/Mock Leather												
OVERALL DIMENSIONS			SEAT DIMENSIONS			BACK DIMENSIONS						
W	D	H	W	D	H	W	H					
26.5	26.5	33.5	17.5	18	18	19	15.5					

RTA 00



**Ottoman**  
COM Yardage: 1.50  
Freight Class: 250  
Product Weight (lbs.): 22  
Cubic Feet Per Carton: 6

Ergonomic Features:  
N

	1	2	3	4	5	6	7	8	9	10	11	12
<b>2814</b>	678	717	748	794	858	882	939	1048	1101	1200	1337	1508
<b>2814LM</b>	-	-	-	-	860	-	-	1049	-	1201	1346	1517
Leather/Mock Leather												
OVERALL DIMENSIONS			SEAT DIMENSIONS			BACK DIMENSIONS						
W	D	H	W	D	H	W	H					
23.5	18.75	17.75	20.5	18.5	17-22	20	21					

RTA 00

LUX



model LX2426AC



model LX8033S

STANDARD FEATURES

- Contemporary styling featuring luxurious cushioning.
- Sofa cushions are removable.
- Fully upholstered. Wood legs with non marking clear glides.
- Cylindrical bolsters included with lounge chair models. One bolster on single seat lounge chair and two bolsters on two-seat and three-seat sofas.
- \*\*This item may require a longer lead time. Please contact your Global sales representative for further information.

OPTIONAL FEATURES

- Wood frames are available in Absolute (AAM), Black (BKM), Cherry (ACM), English Oak (EOM), Espresso Cafe (ECM), Fruitwood (TFM), Gray (HGM), Honey (AHM), Mahogany (TMM), Maple (AVM), Medium Walnut (MWM), Night (ASM), Shaker Cherry (SKM), Walnut (TWM), WC Cream (WTM), White (WHM) and Winter Cherry (WCM). Please Specify. Genuine maple faced veneers and solids are used.
- Upholstery options: fabric, vinyl, leather or leather/mock leather combinations.

DESCRIPTION	FEATURES	MODEL#	STANDARD TEXTILE GRADES											
-------------	----------	--------	-------------------------	--	--	--	--	--	--	--	--	--	--	--



Side Chair

COM Yardage: 3  
Freight Class: 300  
Product Weight (lbs.): 20  
Cubic Feet Per Carton: 11.60

	1	2	3	4	5	6	7	8	9	10	11	12
LX2226SC	764	846	881	932	1005	1030	1094	1215	1274	1387	1540	1731

OVERALL DIMENSIONS			SEAT DIMENSIONS			BACK DIMENSIONS	
W	D	H	W	D	H	W	H
22	26.5	35	19	19.5	19.5	19	18

RTA 00



Armchair

COM Yardage: 3  
Freight Class: 250  
Product Weight (lbs.): 27  
Cubic Feet Per Carton: 12.60

	1	2	3	4	5	6	7	8	9	10	11	12
LX2426AC	993	1106	1154	1227	1331	1368	1460	1633	1716	1877	2097	2369

OVERALL DIMENSIONS			SEAT DIMENSIONS			BACK DIMENSIONS	
W	D	H	W	D	H	W	H
24.5	26.5	35	19	19.5	19.5	19	18

RTA 00



Lounge Chair

COM Yardage: 8.50  
Freight Class: 250  
Product Weight (lbs.): 65  
Cubic Feet Per Carton: 21

	1	2	3	4	5	6	7	8	9	10	11	12
LX3433CH	1935	2178	2296	2471	2721	2810	3028	3445	3645	4031	4556	5211

OVERALL DIMENSIONS			SEAT DIMENSIONS			BACK DIMENSIONS	
W	D	H	W	D	H	W	H
34	33	33	-	-	-	-	-

RTA 00

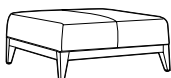

Ottoman

COM Yardage: 2.50  
Freight Class: 250  
Product Weight (lbs.): 40  
Cubic Feet Per Carton: 12

	1	2	3	4	5	6	7	8	9	10	11	12
LX3636TT	1847	2002	2050	2123	2228	2264	2356	2529	2613	2773	2993	3266

OVERALL DIMENSIONS			SEAT DIMENSIONS			BACK DIMENSIONS	
W	D	H	W	D	H	W	H
36	36	16	-	-	-	-	-

RTA 00



ML™



model ML2630

### STANDARD FEATURES

- Modern seating with a distinctive retro design.
- Features a steel tube frame, legs and arms.
- Fully upholstered continuous seat and back cushions.
- Standard with non marring, Black glides.
- Available in fabric, vinyl and leather.

### OPTIONAL FEATURES

- Available in five frame finish options. Please specify Chrome (**CH**), Brushed Chrome (**BCH**), Black (**BLK**), Designer White (**DWT**) or Tungsten (**TUN**). No upcharge applies. Please specify.

DESCRIPTION	FEATURES	MODEL#	STANDARD TEXTILE GRADES											
-------------	----------	--------	-------------------------	--	--	--	--	--	--	--	--	--	--	--



### Counter Height Stool - 24" Seat Height

COM Yardage: 1  
 Freight Class: 250  
 Product Weight (lbs.): 25  
 Cubic Feet Per Carton: 5.30

	1	2	3	4	5	6	7	8	9	10	11	12
<b>ML171724</b>	1110	1124	1136	1153	1176	1187	1209	1243	1268	1298	1358	1423

OVERALL DIMENSIONS			SEAT DIMENSIONS			BACK DIMENSIONS	
W	D	H	W	D	H	W	H
17	17	24	17	16	23	-	-

RTA 00



### Bar Height Stool - 30" Seat Height

COM Yardage: 1  
 Freight Class: 150  
 Product Weight (lbs.): 25  
 Cubic Feet Per Carton: 5.30

	1	2	3	4	5	6	7	8	9	10	11	12
<b>ML171730</b>	1145	1158	1169	1185	1206	1214	1232	1268	1286	1320	1365	1423

OVERALL DIMENSIONS			SEAT DIMENSIONS			BACK DIMENSIONS	
W	D	H	W	D	H	W	H
17	17	30	17	16	29	-	-

RTA 00

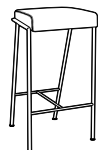

### Bar Height Stool - 33" Seat Height

COM Yardage: 1  
 Freight Class: 150  
 Product Weight (lbs.): 25  
 Cubic Feet Per Carton: 5.30

	1	2	3	4	5	6	7	8	9	10	11	12
<b>ML171733</b>	1167	1238	1249	1264	1284	1291	1310	1344	1361	1393	1436	1491

OVERALL DIMENSIONS			SEAT DIMENSIONS			BACK DIMENSIONS	
W	D	H	W	D	H	W	H
17	17	33	17	16	32	-	-

RTA 00





### Ottoman

COM Yardage: 1.25  
 Freight Class: 150  
 Product Weight (lbs.): 23  
 Cubic Feet Per Carton: 4

	1	2	3	4	5	6	7	8	9	10	11	12
<b>ML2121</b>	787	852	871	901	943	957	993	1063	1096	1160	1248	1358

OVERALL DIMENSIONS			SEAT DIMENSIONS			BACK DIMENSIONS	
W	D	H	W	D	H	W	H
21	21	17	-	-	-	-	-

RTA 00

DESCRIPTION	FEATURES	MODEL#	STANDARD TEXTILE GRADES												
			1	2	3	4	5	6	7	8	9	10	11	12	
 <p><b>Dining Chair</b> COM Yardage: 1.75 Freight Class: 150 Product Weight (lbs.): 42 Cubic Feet Per Carton: 10</p>		<b>ML2326</b>	924	1021	1060	1118	1201	1231	1303	1442	1508	1638	1812	2032	
	<b>OVERALL DIMENSIONS</b>			<b>SEAT DIMENSIONS</b>			<b>BACK DIMENSIONS</b>								
	<b>W D H</b>			<b>W D H</b>			<b>W H</b>								
	23 26 30			20 18.5 18.5			20 16								
		<b>RTA 00</b>													
 <p><b>Lounge Chair</b> COM Yardage: 2.50 Freight Class: 250 Product Weight (lbs.): 50 Cubic Feet Per Carton: 14</p>		<b>ML2630</b>	1387	1519	1567	1640	1743	1780	1872	2046	2128	2289	2509	2781	
	<b>OVERALL DIMENSIONS</b>			<b>SEAT DIMENSIONS</b>			<b>BACK DIMENSIONS</b>								
	<b>W D H</b>			<b>W D H</b>			<b>W H</b>								
	26 30 34			23 20 18.5			18.5 20.5								
		<b>RTA 00</b>													

ML PARK



model ML4634CH



model ML8634

STANDARD FEATURES

- Armless modern lounge seating with a distinctive retro design.
- Features beautiful aluminum legs with Black glides.
- Fully upholstered continuous seat and back cushions with distinctive seams.
- Upholstery options: fabric, vinyl, leather or leather/mock leather combination.

OPTIONAL FEATURES

- Optional fixed back cushion (FC) is available on lounge models with upcharge. Please specify. Model ML4634, add \$132. Model ML6634, add \$176. Model ML8634, add \$219.
- Available in five leg finish options. Specify: Black (BK), Brushed Aluminum (BU), Designer White (DW), Polished Aluminum (PA) or Tungsten (TU). No upcharge applies.

DESCRIPTION	FEATURES	MODEL#	STANDARD TEXTILE GRADES											
-------------	----------	--------	-------------------------	--	--	--	--	--	--	--	--	--	--	--



Ottoman

COM Yardage: 1.50  
 Freight Class: 150  
 Product Weight (lbs.): 35  
 Cubic Feet Per Carton: 12

	1	2	3	4	5	6	7	8	9	10	11	12
ML2634	1529	1559	1581	1615	1662	1684	1726	1795	1847	1906	2027	2155

OVERALL DIMENSIONS			SEAT DIMENSIONS			BACK DIMENSIONS	
W	D	H	W	D	H	W	H
26.75	26.75	18.25	26.75	-	20	-	-

RTA 00



Lounge Chair

COM Yardage: 7.25  
 Freight Class: 250  
 Product Weight (lbs.): 85  
 Cubic Feet Per Carton: 14

	1	2	3	4	5	6	7	8	9	10	11	12
ML4634	2621	2790	2923	3122	3407	3539	3796	4206	4521	4871	5594	6364

OVERALL DIMENSIONS			SEAT DIMENSIONS			BACK DIMENSIONS	
W	D	H	W	D	H	W	H
42.75	34	32	42.75	22	19	27	13

RTA 00

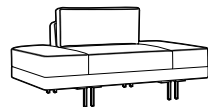

Two Seat Sofa

COM Yardage: 7.50  
 Freight Class: 250  
 Product Weight (lbs.): 120  
 Cubic Feet Per Carton: 41

	1	2	3	4	5	6	7	8	9	10	11	12
ML6634	2830	3169	3323	3559	3891	4010	4301	4855	5123	5637	6338	7210

OVERALL DIMENSIONS			SEAT DIMENSIONS			BACK DIMENSIONS	
W	D	H	W	D	H	W	H
66	34	32	66	22	19	27	13

RTA 00

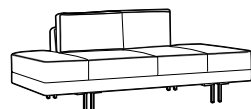

Three Seat Sofa

COM Yardage: 11  
 Freight Class: 250  
 Product Weight (lbs.): 145  
 Cubic Feet Per Carton: 83

	1	2	3	4	5	6	7	8	9	10	11	12
ML8634	3735	4192	4408	4729	5186	5350	5749	6512	6879	7587	8549	9750

OVERALL DIMENSIONS			SEAT DIMENSIONS			BACK DIMENSIONS	
W	D	H	W	D	H	W	H
86	34	32	86	22	19	52	13

RTA 00



ORION™



model 8481



model 8482

STANDARD FEATURES

- The clean, transitional Orion lounge collection provides a touch of sophistication with wood arm caps and matching legs.
- A full family of stylish products available in a lounge chair, two seater and three seater sofas as well as a coordinating ottoman.
- Standard with wood arm caps and wood legs made from maple solids and veneers. Available in all standard wood finishes.
- Standard with white glides.
- Upholstery options: fabric, vinyl, leather or leather/mock leather combination.

OPTIONAL FEATURES

- Wood armcaps and wood legs available in Absolute (AAM), Black (BKM), Cherry (ACM), Espresso Cafe (ECM), English Oak (EOM), Fruitwood (TFM), Gray (HGM), Honey (AHM), Mahogany (TMM), Maple (AVM), Medium Walnut (MWM), Night (ASM), Shaker Cherry (SKM), Walnut (TWM), WC Cream (WTM), White (WHM) and Winter Cherry (WCM). Please specify.
- Fully Upholstered armcaps are available (U). Please specify. No Upcharge.

DESCRIPTION	FEATURES	MODEL#	STANDARD TEXTILE GRADES											
-------------	----------	--------	-------------------------	--	--	--	--	--	--	--	--	--	--	--



**Lounge Chair**  
COM Yardage: 4.50  
Freight Class: 250  
Product Weight (lbs.): 60  
Cubic Feet Per Carton: 22

	1	2	3	4	5	6	7	8	9	10	11	12
<b>8481</b>	1125	1281	1359	1476	1642	1702	1847	2124	2258	2516	2865	3302
Wood armcaps												
<b>8481U</b>	1125	1281	1359	1476	1642	1702	1847	2124	2258	2516	2865	3302
Upholstered arms												

OVERALL DIMENSIONS			SEAT DIMENSIONS			BACK DIMENSIONS	
W	D	H	W	D	H	W	H
29	31	34.5	21.5	19.5	17	21.5	20.5

RTA 00

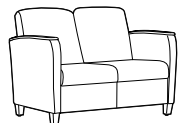

**Two Seat Sofa**  
COM Yardage: 6.75  
Freight Class: 250  
Product Weight (lbs.): 95  
Cubic Feet Per Carton: 37

	1	2	3	4	5	6	7	8	9	10	11	12
<b>8482</b>	1472	1719	1854	2060	2352	2456	2709	3196	3429	3881	4491	5256
Wood armcaps												
<b>8482U</b>	1472	1719	1854	2060	2352	2456	2709	3196	3429	3881	4491	5256
Upholstered arms												

OVERALL DIMENSIONS			SEAT DIMENSIONS			BACK DIMENSIONS	
W	D	H	W	D	H	W	H
50	31	34.5	42.5	19.5	17	42.5	20.5

RTA 00

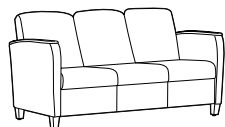

**Three Seat Sofa**  
COM Yardage: 9.25  
Freight Class: 250  
Product Weight (lbs.): 125  
Cubic Feet Per Carton: 57

	1	2	3	4	5	6	7	8	9	10	11	12
<b>8483</b>	1862	2224	2439	2762	3218	3382	3782	4545	4912	5620	6583	7782
Wood armcaps												
<b>8483U</b>	1862	2224	2439	2762	3218	3382	3782	4545	4912	5620	6583	7782
Upholstered arms												

OVERALL DIMENSIONS			SEAT DIMENSIONS			BACK DIMENSIONS	
W	D	H	W	D	H	W	H
71	31	34.5	63.5	19.5	17	63.5	20.5

RTA 00



**Ottoman**  
COM Yardage: 1.5  
Freight Class: 250  
Product Weight (lbs.): 15  
Cubic Feet Per Carton: 7

	1	2	3	4	5	6	7	8	9	10	11	12
<b>8484</b>	440	512	551	609	694	723	795	934	1000	1130	1303	1523

OVERALL DIMENSIONS			SEAT DIMENSIONS			BACK DIMENSIONS	
W	D	H	W	D	H	W	H
17	22	17	-	-	-	-	-

RTA 00

## PRAIRIE™



model 3481



model 3482

### STANDARD FEATURES



- Featuring, gently barrel shaped arms that provide an attractive appearance.
- Fully upholstered. Tapered wood skirt and legs.
- Series includes lounge chair, two seat and three seat sofa.

### OPTIONAL FEATURES

- Tapered wood legs are available in Absolute (AAM), Black (BKM), Cherry (ACM), Espresso Cafe (ECM), English Oak (EOM), Fruitwood (TFM), Gray (HGM), Honey (AHM), Mahogany (TMM), Maple (AVM), Medium Walnut (MWM), Night (ASM), Shaker Cherry (SKM), Walnut (TWM), WC Cream (WTM), White (WHM) and Winter Cherry (WCM). Please specify. Genuine maple faced veneers and solids are used.

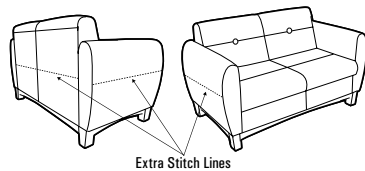
### STITCH DETAIL WHEN UPHOLSTERED IN ALL LEATHER - ILLUSTRATIONS BELOW

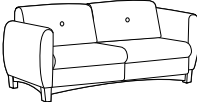

DESCRIPTION	FEATURES	MODEL#	STANDARD TEXTILE GRADES											
			1	2	3	4	5	6	7	8	9	10	11	12
 <b>Lounge Chair</b> COM Yardage: 4.25 Freight Class: 150 Product Weight (lbs.): 80 Cubic Feet Per Carton: 19.25		<b>3481</b>	1495	1628	1734	1891	2115	2195	2389	2763	2944	3289	3761	4347
			<b>OVERALL DIMENSIONS</b>			<b>SEAT DIMENSIONS</b>			<b>BACK DIMENSIONS</b>					
			<b>W</b>	<b>D</b>	<b>H</b>	<b>W</b>	<b>D</b>	<b>H</b>	<b>W</b>	<b>H</b>				
			32	29	30.5	21	19	16	21	14.5				
			<b>RTA 00</b>											
 <b>Two Seat Sofa</b> COM Yardage: 6.25 Freight Class: 250 Product Weight (lbs.): 106 Cubic Feet Per Carton: 41.25		<b>3482</b>	2122	2293	2430	2634	2927	3031	3284	3770	4001	4453	5066	5830
			<b>OVERALL DIMENSIONS</b>			<b>SEAT DIMENSIONS</b>			<b>BACK DIMENSIONS</b>					
			<b>W</b>	<b>D</b>	<b>H</b>	<b>W</b>	<b>D</b>	<b>H</b>	<b>W</b>	<b>H</b>				
			52.5	29	30.5	42	19	16	42	14.5				
			<b>RTA 00</b>											
 <b>Three Seat Sofa</b> COM Yardage: 9.50 Freight Class: 250 Product Weight (lbs.): 150 Cubic Feet Per Carton: 55.50		<b>3483</b>	2668	2873	3036	3282	3628	3755	4055	4633	4912	5450	6179	7090
			<b>OVERALL DIMENSIONS</b>			<b>SEAT DIMENSIONS</b>			<b>BACK DIMENSIONS</b>					
			<b>W</b>	<b>D</b>	<b>H</b>	<b>W</b>	<b>D</b>	<b>H</b>	<b>W</b>	<b>H</b>				
			73.5	29	30.5	63.5	19	16	63.5	14.5				
			<b>RTA 00</b>											

RIVER™



Sample Layout



Sample Layout

STANDARD FEATURES

- A modular seating series that is composed of modular linking units in straight, curved and corner units. Soft seating models are available with standard height, high and extended high backs. All linking units can be used together in any combination to create a wide variety of layouts.
- The unique tapered legs (swaged legs) are made of welded steel, heavy duty construction, with each leg bolted directly to the frame. The extremely robust construction insures trouble free performance in any environment. All units except for the Laptop Tables have the same leg height of 6.5". The leg height makes it easier to clean under the product.
- Each leg is standard with adjustable black leveling glides and are non-marking. Wood legs and casters are not available.
- All cushions are fixed and non-removable (cushions will not migrate). Perimeter seams feature a decorative single stitch detail, which makes seams lay flat and adds extra seam strength.
- Seating frames are heavy duty with interlocking plywood, puzzle box construction, made for rugged active environments. Seats are high density with highly resilient foam and are equipped with a synthetic rubberized webbing suspension system for extra comfort.
- Front edge of the seat, angles slightly inward, so feet have freedom of movement and shoe heels don't rub on the seat. This inward slanting matches the inward angles of the back. Benches and connecting end tables also reflect the inward angles on the front and back faces, so all units coordinate in visual appearance.
- High Traffic (HT) units are also available and are listed separately. Please see page 312 for High Traffic Models.
- Most units can be ganged together with a quick connect, disconnect feature. Ganging hardware is standard and is factory installed. Ganging hardware swivels out of sight when not in use.

OPTIONAL FEATURES

- Most tables and seating units can be specified with Power/USB terminals, which includes two power outlets, two double USB terminals and a black 60" three-prong power cord. Each Power/USB module is set in predetermined locations, as shown in the electrical illustrations below. Electrical units must be factory installed.
- To add a Power/USB module: From the electrical illustrations below, please specify **J1, W1, J2, W2, J3, W4, J4, W4, J6 or W6** after the product model number. Please note on seating units, if both right and left locations are required, add both **J1/J3 or W1/W3** to the model number. Add \$695 for each module/location required.
- Power/USB modules are available with either Jet Black (**J**) face plate with black Power/USB receptacles or with a White (**W**) face plate with white Power/USB receptacles.
- Tables are made with high pressure laminate and are offered in the following finishes: Absolute Acajou (**ACJ**), Asian Night (**ASN**), Avant Cherry (**AWC**), Avant Honey (**AWH**), Clear Maple (**CMB**), Dark Espresso (**DES**), Designer White (**DWT**), Hayden Grey (**HGT**), Tiger Walnut (**TWL**), Walnut Heights (**WHE**), White Chocolate (**WHC**) and Winter Cherry (**WCR**). Please Specify. Custom High Pressure laminate finishes will be considered upon request.
- The metal legs are standard in Chrome (**CHR**). Tungsten (**TUN**) and Black (**BLK**) finishes are also available at no up charge. Laptop tables bases are only available in Tungsten (**TUN**) and Black (**BLK**) finishes.
- All models are available in fabric or vinyl. Not available in Crescent or Silhouette fabric. Leather upholstery is available upon special request and is only recommended for seat use. If more than one fabric or a fabric/vinyl leather combination is required, please fill out a "Seating Multiple Textile" form, specifying each fabric location. Please contact Customer Care for more information.

ELECTRICAL PLACEMENT

Soft Seating

Locations available on left side J1 (black) or W1 (white), right side J3 (black), or W3 (white) or both sides J1/J3 (black) or W1/W3 (white).

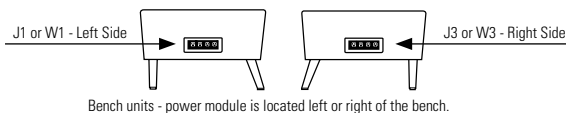
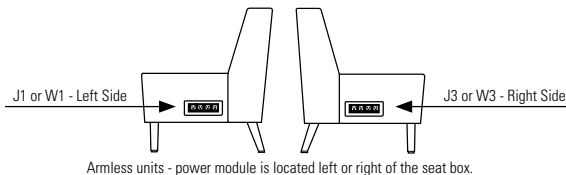
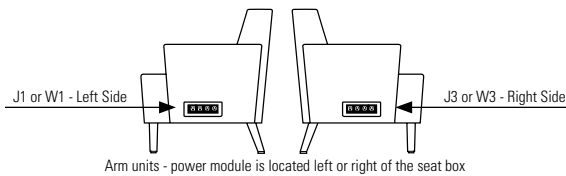

Coffee/End Tables

Primary location is on the top of the unit, centered J2 (black) or W2 (white). Secondary Location is end/side of the unit J1 (black) or W1 (white).

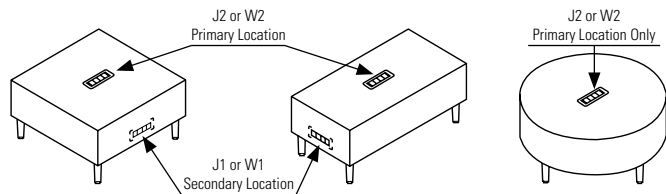

Primary location is on the top rear/edge of the unit J4 (black) or W4 (white). Secondary Location is the back side of the unit J6 (black) or W6 (white).

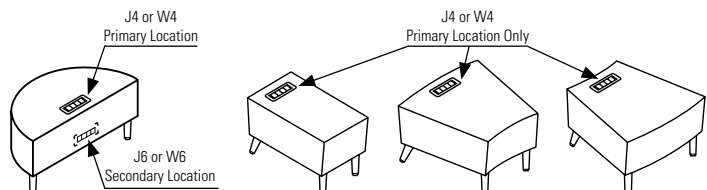

## SAMPLE LAYOUTS

**RVR101 (Layout 1)**

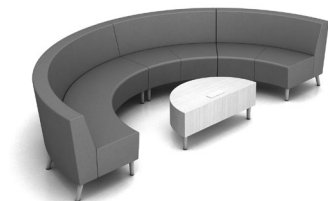

Qty	Model Number	Description	Dimensions	List Price
4	<b>7710NA</b>	Armless IS Curve - Two Seat - Standard Back	55 x 29.5 x 32	2289 x 4
1	<b>7737W6</b>	42" Half Round Laminate Coffee Table w/ W6 Rear Power/USB Module	42 x 21 x 17 upcharge	972 695

**SAMPLE LAYOUT TOTAL (Starting at Grade 1)**

**\$10,823**

**RVR102 (Layout 2)**



Qty	Model Number	Description	Dimensions	List Price
8	<b>7714NA</b>	Armless OS Curve - Two Seater - High Back	54 x 29.5 x 41.5	2730 x 8

**SAMPLE LAYOUT TOTAL (Starting at Grade 1)**

**\$21,840**

**RVR103 (Layout 3)**

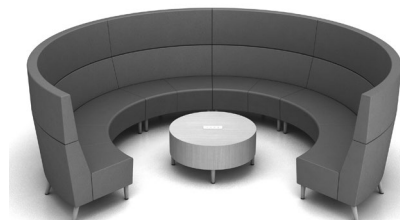

Qty	Model Number	Description	Dimensions	List Price
6	<b>7712NA</b>	Armless IS Curve - Two Seater - Extended Back	55 x 29.5 x 47	3200 x 6
1	<b>7734W2</b>	36" Dia - Round Laminate Coffee Table w/ W2 Center Power/USB Module	36 x 36 x 17 upcharge	1132 695

**SAMPLE LAYOUT TOTAL (Starting at Grade 1)**

**\$21,027**

**RVR104 (Layout 4)**



Qty	Model Number	Description	Dimensions	List Price
2	<b>7712NA</b>	Armless IS Curve - Two Seater - Extended Back	55 x 29.5 x 47	3200 x 2
2	<b>7712NAW3</b>	Armless IS Curve - Two Seater - Extended Back w/ W3 Right Power/USB Module	55 x 29.5 x 47 upcharge	3200 x 2 695 x 2
2	<b>7726</b>	IS Curve - Two Seater Bench	54 x 28 x 17.5	1942 x 2
1	<b>7734</b>	36" Dia - Round Laminate Coffee Table	36 x 36 x 17	1132

**SAMPLE LAYOUT TOTAL (Starting at Grade 1)**

**\$19,206**

**RVR105 (Layout 5)**



Qty	Model Number	Description	Dimensions	List Price
3	<b>7711NA</b>	Armless IS Curve - Two Seater - High Back	55 x 29.5 x 41.5	2907 x 3
3	<b>7712NAW3</b>	Armless IS Curve - Two Seater - Extended Back w/ W3 Right Power/USB Module	55 x 29.5 x 47 upcharge	3200 x 3 695 x 2
1	<b>7738</b>	Rectangular Laminate End Table	15 x 26.5 x 17	919
2	<b>7743</b>	18" Dia. Round Laminate Laptop Table	18 x 18 x 25.25	556 x 2

**SAMPLE LAYOUT TOTAL (Starting at Grade 1)**

**\$21,122**

## SAMPLE LAYOUTS

## RVR106 (Layout 6)



Qty	Model Number	Description	Dimensions	List Price
1	<b>7709R</b>	Three Seater - Extended Back w/Right Arm	75 x 29.5 x 47	4357
1	<b>7709L</b>	Three Seater - Extended Back w/Left Arm	75 x 29.5 x 47	4357
1	<b>7718</b>	Armless Corner Unit - Extended Back	38 x 38. x 47	3752
1	<b>7732W2</b>	36" Square Laminate Coffee Table w/ W2 Center Power/USB Module	36 x 36. x 17 upcharge	1037 695

**SAMPLE LAYOUT TOTAL (Starting at Grade 1)****\$14,198**

## RVR107 (Layout 7)



Qty	Model Number	Description	Dimensions	List Price
1	<b>7704NA</b>	Armless Two Seater - Standard. Back	48.5 x 29.5 x 32	1981
2	<b>7716</b>	Armless Corner Unit - Standard. Back	38 x 38 x 32	2797 x 2
1	<b>7725</b>	Two Seater Bench	48.5 x 28 x 17.5	1430
1	<b>7728</b>	Square Single Seater Bench	24.5 x 29 x 17.5	977
1	<b>7731</b>	30" Square Laminate Coffee Table	30 x 30 x 17	912

**SAMPLE LAYOUT TOTAL (Starting at Grade 1)****\$10,894**

## RVR108 (Layout 8)



Qty	Model Number	Description	Dimensions	List Price
2	<b>7708NAW3</b>	Armless Three Seater - High Back w/ W3 Right Power/USB Module	75 x 29.5 x 41.5 upcharge	3757 x 2 695 x 2
2	<b>7708NAW1</b>	Armless Three Seater - High Back w/ W1 Left Power/USB Module	72.5 x 29.5 x 41.5 upcharge	3757 x 2 695 x 2
2	<b>7745</b>	16" Square Laminate Laptop Table	16 x 16 x 25.25	544 x 2

**SAMPLE LAYOUT TOTAL (Starting at Grade 1)****\$18,878**

## RVR109 (Layout 9)



Qty	Model Number	Description	Dimensions	List Price
2	<b>7702</b>	Lounge Chair - High Back w/Arms	29.5 x 29.5 x 41.5	2119 x 2
1	<b>7708NAW1</b>	Armless Three Seater - High Back w/ W1 Left Power/USB Module	72.5 x 29.5 x 41.5 upcharge	3757 695
1	<b>7708NAW3</b>	Armless Three Seater - High Back w/ W3 Right Power/USB Module	72.5 x 29.5 x 41.5 upcharge	3757 695
1	<b>7733</b>	Rectangular Laminate Coffee Table	40 x 20 x 17	917

**SAMPLE LAYOUT TOTAL (Starting at Grade 1)****\$14,059**

## RVR110 (Layout 10)

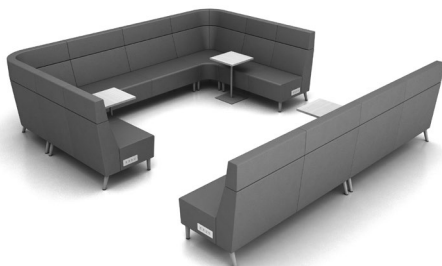

Qty	Model Number	Description	Dimensions	List Price
1	<b>7705NAW3</b>	Armless Two Seater - High Back w/ W3 Right Power/USB Module	48.5 x 29.5 x 41.5 upcharge	2428 695
1	<b>7705NAW1</b>	Armless Two Seater - High Back w/ W1 Left Power/USB Module	48.5 x 29.5 x 41.5 upcharge	2428 695
1	<b>7708NA</b>	Armless Three Seater - High Back	72.5 x 29.5 x 41.5	3757
1	<b>7708NAW3</b>	Armless Three Seater - High Back w/ W3 Right Power/USB Module	72.5 x 29.5 x 41.5 upcharge	3757 695
1	<b>7708NAW1</b>	Armless Three Seater - High Back w/ W1 Left Power/USB Module	72.5 x 29.5 x 41.5 upcharge	3757 695
2	<b>7717</b>	Armless Corner Unit - High Back	38 x 38. x 41.5	3542 x 2
3	<b>7745</b>	16" Square Laminate Laptop Table	16 x 16 x 25.25	544 x 3

**SAMPLE LAYOUT TOTAL (Starting at Grade 1)****\$27,596**

DESCRIPTION	FEATURES	MODEL#	STANDARD TEXTILE GRADES			
<b>RVR111 (Layout 11)</b>		Qty	Model Number	Description	Dimensions	List Price
		2	<b>7701NA</b>	Armless One Seater - Standard Back	24.5 x 29.5 x 32	1269 x 2
		4	<b>7710NA</b>	Armless IS Curve - Two Seat - Standard Back	55 x 29.5 x 32	2289 x 4
		2	<b>7743</b>	18" Dia. Round Laminate Laptop Table	18 x 18 x 25.25	556 x 2
<b>SAMPLE LAYOUT TOTAL (Starting at Grade 1)</b>						<b>\$12,786</b>

<b>RVR112 (Layout 12)</b>		Qty	Model Number	Description	Dimensions	List Price
		2	<b>7711NA</b>	Armless IS Curve - Two Seater - High Back	55 x 29.5 x 41.5	2907 x 2
		6	<b>7712NA</b>	Armless IS Curve - Two Seater - Extended Back	55 x 29.5 x 47	3200 x 6
		1	<b>7709NA</b>	Armless Three Seater - Extended Back	72.5 x 29.5 x 47	4066
		2	<b>7734</b>	36"Dia - Round Laminate Coffee Table	36 x 36 x 17	1132 x 2
<b>SAMPLE LAYOUT TOTAL (Starting at Grade 1)</b>						<b>\$31,344</b>

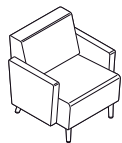

**Lounge Chair - Standard Back w/Arms**  
 COM Yardage: 4  
 Freight Class: 250  
 Product Weight (lbs.): 56  
 Cubic Feet Per Carton: 21.75

For Power/USB module please see electrical placement chart. No ganging hardware.

	1	2	3	4	5	6	7	8	9	10	11	12
<b>7701</b>	1848	1964	2055	2193	2389	2459	2630	2956	3112	3415	3827	4340

OVERALL DIMENSIONS			SEAT DIMENSIONS			BACK DIMENSIONS	
W	D	H	W	D	H	W	H
29.5	29.5	32	24	19	18	24	14

RTA 00

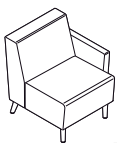

**7701L** (Left Arm)

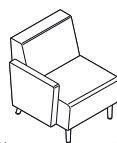

**7701R** (Right Arm)

**Lounge Chair - Standard w/One Arm**  
 COM Yardage: 3.25  
 Freight Class: 250  
 Product Weight (lbs.): 46  
 Cubic Feet Per Carton: 21.75

For Power/USB module please see electrical placement chart. Includes ganging hardware (1 side).

	1	2	3	4	5	6	7	8	9	10	11	12
<b>7701L</b>	1562	1658	1732	1844	2002	2060	2199	2463	2591	2837	3172	3588
<b>7701R</b>	1562	1658	1732	1844	2002	2060	2199	2463	2591	2837	3172	3588

OVERALL DIMENSIONS			SEAT DIMENSIONS			BACK DIMENSIONS	
W	D	H	W	D	H	W	H
27	29.5	32	24	19	18	24	14

RTA 00

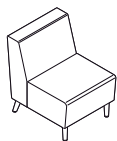

**Armless Lounge Chair - Standard Back**  
 COM Yardage: 2.50  
 Freight Class: 300  
 Product Weight (lbs.): 36  
 Cubic Feet Per Carton: 21.75

For Power/USB module please see electrical placement chart. Includes ganging hardware (2 sides).

	1	2	3	4	5	6	7	8	9	10	11	12
<b>7701NA</b>	1269	1343	1400	1487	1609	1653	1760	1963	2062	2250	2508	2829

OVERALL DIMENSIONS			SEAT DIMENSIONS			BACK DIMENSIONS	
W	D	H	W	D	H	W	H
24.5	29.5	32	24	19	18	24	14

RTA 00

DESCRIPTION FEATURES MODEL# STANDARD TEXTILE GRADES

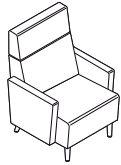

**Lounge Chair - High Back w/Arms**  
 COM Yardage: 4.50  
 Freight Class: 250  
 Product Weight (lbs.): 60  
 Cubic Feet Per Carton: 27.50

For Power/USB module please see electrical placement chart.  
 No ganging hardware.

MODEL#	1	2	3	4	5	6	7	8	9	10	11	12
7702	2119	2250	2354	2509	2728	2807	2999	3366	3543	3884	4346	4923

OVERALL DIMENSIONS			SEAT DIMENSIONS			BACK DIMENSIONS	
W	D	H	W	D	H	W	H
29.5	29.5	41.5	24	19	18	24	24

RTA 00



7702L (Left Arm)

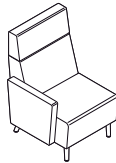

7702R (Right Arm)

**Lounge Chair - High Back w/One Arm**  
 COM Yardage: 4.50  
 Freight Class: 250  
 Product Weight (lbs.): 60  
 Cubic Feet Per Carton: 27.50

For Power/USB module please see electrical placement chart.  
 Includes ganging hardware (1 side).

MODEL#	1	2	3	4	5	6	7	8	9	10	11	12
7702L	1832	1941	2028	2157	2340	2406	2565	2871	3018	3303	3688	4169

MODEL#	1	2	3	4	5	6	7	8	9	10	11	12
7702R	1832	1941	2028	2157	2340	2406	2565	2871	3018	3303	3688	4169

OVERALL DIMENSIONS			SEAT DIMENSIONS			BACK DIMENSIONS	
W	D	H	W	D	H	W	H
29.5	29.5	41.5	24	19	18	24	24

RTA 00



**Armless Lounge Chair - High Back**  
 COM Yardage: 3  
 Freight Class: 300  
 Product Weight (lbs.): 40  
 Cubic Feet Per Carton: 27.50

For Power/USB module please see electrical placement chart.  
 Includes ganging hardware (2 sides).

MODEL#	1	2	3	4	5	6	7	8	9	10	11	12
7702NA	1540	1628	1697	1800	1946	1999	2127	2373	2490	2718	3026	3411

OVERALL DIMENSIONS			SEAT DIMENSIONS			BACK DIMENSIONS	
W	D	H	W	D	H	W	H
24.5	29.5	41.5	24	19	18	24	24

RTA 00

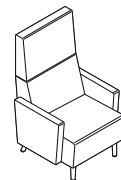

**Lounge Chair - Extended Back w/Arms**  
 COM Yardage: 4.75  
 Freight Class: 250  
 Product Weight (lbs.): 64  
 Cubic Feet Per Carton: 31.50

For Power/USB module please see electrical placement chart.  
 No ganging hardware.

MODEL#	1	2	3	4	5	6	7	8	9	10	11	12
7703	2455	2592	2701	2865	3098	3180	3383	3771	3957	4316	4804	5414

OVERALL DIMENSIONS			SEAT DIMENSIONS			BACK DIMENSIONS	
W	D	H	W	D	H	W	H
29.5	29.5	47	24	19	18	24	29

RTA 00

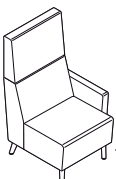

7703L (Left Arm)

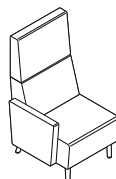

7703R (Right Arm)

**Lounge Chair - Extended Back w/One Arm**  
 COM Yardage: 3.25  
 Freight Class: 300  
 Product Weight (lbs.): 54  
 Cubic Feet Per Carton: 31.50

For Power/USB module please see electrical placement chart.  
 Includes ganging hardware (1 side).

MODEL#	1	2	3	4	5	6	7	8	9	10	11	12
7703L	2169	2284	2376	2514	2708	2778	2948	3275	3432	3735	4146	4660

MODEL#	1	2	3	4	5	6	7	8	9	10	11	12
7703R	2169	2284	2376	2514	2708	2778	2948	3275	3432	3735	4146	4660

OVERALL DIMENSIONS			SEAT DIMENSIONS			BACK DIMENSIONS	
W	D	H	W	D	H	W	H
29.5	29.5	47	24	19	18	24	29

RTA 00

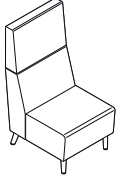

DESCRIPTION	FEATURES	MODEL#	STANDARD TEXTILE GRADES													
			1	2	3	4	5	6	7	8	9	10	11	12		
 <p><b>Armless Lounge Chair - Extended Back</b> COM Yardage: 3.25 Freight Class: 300 Product Weight (lbs.): 44 Cubic Feet Per Carton: 31.50</p>	<p>For Power/USB module please see electrical placement chart. Includes ganging hardware (2 sides).</p>	<b>7703NA</b>	1877	1972	2046	2158	2317	2375	2514	2777	2905	3151	3486	3902		
		<b>OVERALL DIMENSIONS</b>			<b>SEAT DIMENSIONS</b>			<b>BACK DIMENSIONS</b>								
		<b>W</b>	<b>D</b>	<b>H</b>	<b>W</b>	<b>D</b>	<b>H</b>	<b>W</b>	<b>H</b>							
			24.5	29.5	47	24	19	18	24	29						
			<b>RTA 00</b>													

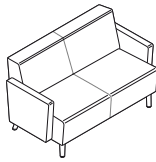
DESCRIPTION	FEATURES	MODEL#	STANDARD TEXTILE GRADES													
			1	2	3	4	5	6	7	8	9	10	11	12		
 <p><b>Two Seater - Standard Back w/Arms</b> COM Yardage: 5.50 Freight Class: 250 Product Weight (lbs.): 91 Cubic Feet Per Carton: 43</p>	<p>For Power/USB module please see electrical placement chart. No ganging hardware.</p>	<b>7704</b>	2555	2714	2839	3029	3298	3394	3629	4078	4293	4709	5274	5980		
		<b>OVERALL DIMENSIONS</b>			<b>SEAT DIMENSIONS</b>			<b>BACK DIMENSIONS</b>								
		<b>W</b>	<b>D</b>	<b>H</b>	<b>W</b>	<b>D</b>	<b>H</b>	<b>W</b>	<b>H</b>							
			53.5	29.5	32	48	19	18	48	14						
			<b>RTA 00</b>													

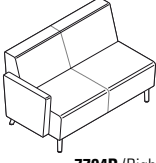
DESCRIPTION	FEATURES	MODEL#	STANDARD TEXTILE GRADES												
			1	2	3	4	5	6	7	8	9	10	11	12	
 <p><b>7704L (Left Arm)</b></p>  <p><b>7704R (Right Arm)</b></p> <p><b>Two Seater - Standard Back w/One Arm</b> COM Yardage: 4.75 Freight Class: 300 Product Weight (lbs.): 81 Cubic Feet Per Carton: 43</p>	<p>For Power/USB module please see electrical placement chart. Includes ganging hardware (1 side).</p>	<b>7704L</b>	2273	2411	2520	2684	2916	2999	3202	3590	3775	4135	4624	5233	
		<b>7704R</b>	2273	2411	2520	2684	2916	2999	3202	3590	3775	4135	4624	5233	
		<b>OVERALL DIMENSIONS</b>			<b>SEAT DIMENSIONS</b>			<b>BACK DIMENSIONS</b>							
<b>W</b>	<b>D</b>	<b>H</b>	<b>W</b>	<b>D</b>	<b>H</b>	<b>W</b>	<b>H</b>								
			51	29.5	32	48	19	18	48	14					
			<b>RTA 00</b>												

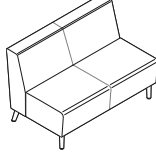
DESCRIPTION	FEATURES	MODEL#	STANDARD TEXTILE GRADES													
			1	2	3	4	5	6	7	8	9	10	11	12		
 <p><b>Armless Two Seater - Standard Back</b> COM Yardage: 6.50 Freight Class: 300 Product Weight (lbs.): 71 Cubic Feet Per Carton: 43</p>	<p>For Power/USB module please see electrical placement chart. Includes ganging hardware (2 sides).</p>	<b>7704NA</b>	1981	2105	2204	2350	2557	2631	2812	3160	3326	3648	4085	4630		
		<b>OVERALL DIMENSIONS</b>			<b>SEAT DIMENSIONS</b>			<b>BACK DIMENSIONS</b>								
		<b>W</b>	<b>D</b>	<b>H</b>	<b>W</b>	<b>D</b>	<b>H</b>	<b>W</b>	<b>H</b>							
			48.5	29.5	32	48	19	18	48	14						
			<b>RTA 00</b>													

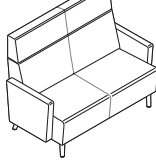
DESCRIPTION	FEATURES	MODEL#	STANDARD TEXTILE GRADES													
			1	2	3	4	5	6	7	8	9	10	11	12		
 <p><b>Two Seater - High Back w/Arms</b> COM Yardage: 6.50 Freight Class: 300 Product Weight (lbs.): 97 Cubic Feet Per Carton: 54</p>	<p>For Power/USB module please see electrical placement chart. No ganging hardware.</p>	<b>7705</b>	3007	3196	3344	3569	3886	4000	4278	4808	5063	5554	6223	7056		
		<b>OVERALL DIMENSIONS</b>			<b>SEAT DIMENSIONS</b>			<b>BACK DIMENSIONS</b>								
		<b>W</b>	<b>D</b>	<b>H</b>	<b>W</b>	<b>D</b>	<b>H</b>	<b>W</b>	<b>H</b>							
			53.5	29.5	41.5	48	19	18	48	24						
			<b>RTA 00</b>													



DESCRIPTION FEATURES MODEL# STANDARD TEXTILE GRADES



7705L (Left Arm)

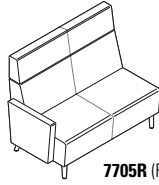

7705R (Right Arm)

**Two Seater - High Back w/One Arm**  
 COM Yardage: 5.75  
 Freight Class: 300  
 Product Weight (lbs.): 87  
 Cubic Feet Per Carton: 54

For Power/USB module please see electrical placement chart. Includes ganging hardware (1 side).

	1	2	3	4	5	6	7	8	9	10	11	12
<b>7705L</b>	2720	2886	3017	3215	3496	3597	3842	4311	4538	4972	5564	6301
<b>7705R</b>	2720	2886	3017	3215	3496	3597	3842	4311	4538	4972	5564	6301

OVERALL DIMENSIONS			SEAT DIMENSIONS			BACK DIMENSIONS	
W	D	H	W	D	H	W	H
51	29.5	41.5	48	19	18	48	24

RTA 00

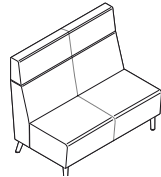

**Armless Two Seater - High Back**  
 COM Yardage: 5.25  
 Freight Class: 300  
 Product Weight (lbs.): 77  
 Cubic Feet Per Carton: 54

For Power/USB module please see electrical placement chart. Includes ganging hardware (2 sides).

	1	2	3	4	5	6	7	8	9	10	11	12
<b>7705NA</b>	2428	2580	2701	2882	3138	3231	3454	3883	4089	4486	5026	5699

OVERALL DIMENSIONS			SEAT DIMENSIONS			BACK DIMENSIONS	
W	D	H	W	D	H	W	H
48.5	29.5	41.5	48	19	18	48	24

RTA 00

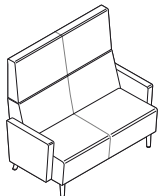

**Two Seater - Extended Back w/Arms**  
 COM Yardage: 7  
 Freight Class: 300  
 Product Weight (lbs.): 102  
 Cubic Feet Per Carton: 62.75

For Power/USB module please see electrical placement chart. No ganging hardware.

	1	2	3	4	5	6	7	8	9	10	11	12
<b>7706</b>	3173	3376	3536	3778	4119	4243	4541	5111	5386	5917	6636	7533

OVERALL DIMENSIONS			SEAT DIMENSIONS			BACK DIMENSIONS	
W	D	H	W	D	H	W	H
53.5	29.5	47	48	19	18	48	29

RTA 00



7706L (Left Arm)

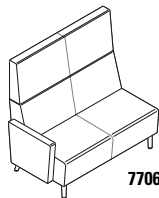

7706R (Right Arm)

**Two Seater - Extended Back w/One Arm**  
 COM Yardage: 6.25  
 Freight Class: 300  
 Product Weight (lbs.): 92  
 Cubic Feet Per Carton: 62.75

For Power/USB module please see electrical placement chart. Includes ganging hardware (1 side).

	1	2	3	4	5	6	7	8	9	10	11	12
<b>7706L</b>	2886	3066	3209	3425	3729	3838	4106	4616	4861	5335	5977	6778
<b>7706R</b>	2886	3066	3209	3425	3729	3838	4106	4616	4861	5335	5977	6778

OVERALL DIMENSIONS			SEAT DIMENSIONS			BACK DIMENSIONS	
W	D	H	W	D	H	W	H
51	29.5	47	48	19	18	48	29

RTA 00

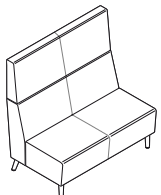

**Armless Two Seater - Extended Back**  
 COM Yardage: 5.75  
 Freight Class: 300  
 Product Weight (lbs.): 82  
 Cubic Feet Per Carton: 62.75

For Power/USB module please see electrical placement chart. Includes ganging hardware (2 sides).

	1	2	3	4	5	6	7	8	9	10	11	12
<b>7706NA</b>	2593	2760	2892	3089	3371	3472	3717	4185	4412	4847	5438	6175

OVERALL DIMENSIONS			SEAT DIMENSIONS			BACK DIMENSIONS	
W	D	H	W	D	H	W	H
48.5	29.5	47	48	19	18	48	29

RTA 00

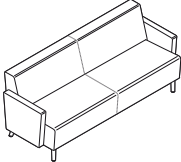
DESCRIPTION	FEATURES	MODEL#	STANDARD TEXTILE GRADES													
			1	2	3	4	5	6	7	8	9	10	11	12		
 <p><b>Three Seater - Standard Back w/Arms</b> COM Yardage: 8.25 Freight Class: 250 Product Weight (lbs.): 133 Cubic Feet Per Carton: 54</p>	<p>For Power/USB module please see electrical placement chart. No ganging hardware.</p>	<b>7707</b>	3800	4037	4228	4512	4914	5059	5411	6085	6408	7032	7881	8939		
		<b>OVERALL DIMENSIONS</b>			<b>SEAT DIMENSIONS</b>			<b>BACK DIMENSIONS</b>								
		<b>W</b>	<b>D</b>	<b>H</b>	<b>W</b>	<b>D</b>	<b>H</b>	<b>W</b>	<b>H</b>							
			77.5	29.5	32	72	19	18	72	14						
			<b>RTA 00</b>													

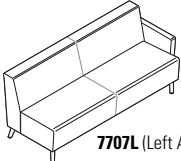
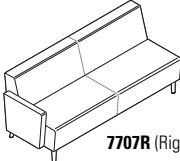
DESCRIPTION	FEATURES	MODEL#	STANDARD TEXTILE GRADES													
			1	2	3	4	5	6	7	8	9	10	11	12		
 <p><b>7707L (Left Arm)</b></p>	 <p><b>7707R (Right Arm)</b></p>	<b>7707L</b>	3515	3737	3916	4182	4560	4697	5028	5659	5963	6550	7347	8341		
		<b>OVERALL DIMENSIONS</b>			<b>SEAT DIMENSIONS</b>			<b>BACK DIMENSIONS</b>								
		<b>W</b>	<b>D</b>	<b>H</b>	<b>W</b>	<b>D</b>	<b>H</b>	<b>W</b>	<b>H</b>							
			75	29.5	32	72	19	18	72	14						
			<b>RTA 00</b>													

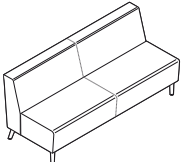
DESCRIPTION	FEATURES	MODEL#	STANDARD TEXTILE GRADES													
			1	2	3	4	5	6	7	8	9	10	11	12		
 <p><b>Armless Three Seater - Standard Back</b> COM Yardage: 7 Freight Class: 250 Product Weight (lbs.): 113 Cubic Feet Per Carton: 54</p>	<p>For Power/USB module please see electrical placement chart. Includes ganging hardware (2 sides).</p>	<b>7707NA</b>	3221	3425	3585	3827	4169	4290	4590	5161	5436	5965	6685	7582		
		<b>OVERALL DIMENSIONS</b>			<b>SEAT DIMENSIONS</b>			<b>BACK DIMENSIONS</b>								
		<b>W</b>	<b>D</b>	<b>H</b>	<b>W</b>	<b>D</b>	<b>H</b>	<b>W</b>	<b>H</b>							
			72.5	29.5	32	72	19	18	72	14						
			<b>RTA 00</b>													

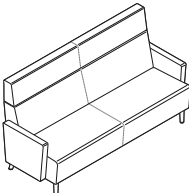
DESCRIPTION	FEATURES	MODEL#	STANDARD TEXTILE GRADES													
			1	2	3	4	5	6	7	8	9	10	11	12		
 <p><b>Three Seater - High Back w/Arms</b> COM Yardage: 10.50 Freight Class: 250 Product Weight (lbs.): 139 Cubic Feet Per Carton: 68</p>	<p>For Power/USB module please see electrical placement chart. No ganging hardware.</p>	<b>7708</b>	4330	4631	4872	5235	5747	5931	6379	7236	7648	8442	9523	10869		
		<b>OVERALL DIMENSIONS</b>			<b>SEAT DIMENSIONS</b>			<b>BACK DIMENSIONS</b>								
		<b>W</b>	<b>D</b>	<b>H</b>	<b>W</b>	<b>D</b>	<b>H</b>	<b>W</b>	<b>H</b>							
			77.5	29.5	41.5	72	19	18	72	24						
			<b>RTA 00</b>													

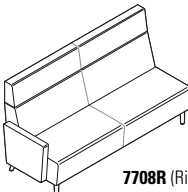
DESCRIPTION	FEATURES	MODEL#	STANDARD TEXTILE GRADES													
			1	2	3	4	5	6	7	8	9	10	11	12		
 <p><b>7708L (Left Arm)</b></p>	 <p><b>7708R (Right Arm)</b></p>	<b>7708L</b>	4049	4330	4554	4890	5366	5537	5953	6748	7130	7869	8871	10122		
		<b>OVERALL DIMENSIONS</b>			<b>SEAT DIMENSIONS</b>			<b>BACK DIMENSIONS</b>								
		<b>W</b>	<b>D</b>	<b>H</b>	<b>W</b>	<b>D</b>	<b>H</b>	<b>W</b>	<b>H</b>							
			75	29.5	41.5	72	19	18	72	24						
			<b>RTA 00</b>													

DESCRIPTION FEATURES MODEL# STANDARD TEXTILE GRADES

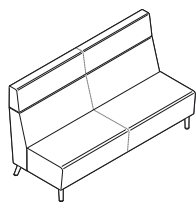

**Armless Three Seater - High Back**  
 COM Yardage: 9.25  
 Freight Class: 300  
 Product Weight (lbs.): 119  
 Cubic Feet Per Carton: 68

For Power/USB module please see electrical placement chart.  
 Includes ganging hardware (2 sides).

MODEL#	1	2	3	4	5	6	7	8	9	10	11	12
7708NA	3757	4025	4237	4556	5007	5170	5564	6320	6682	7381	8333	9520

OVERALL DIMENSIONS			SEAT DIMENSIONS			BACK DIMENSIONS	
W	D	H	W	D	H	W	H
72.5	29.5	41.5	72	19	18	72	24

RTA 00

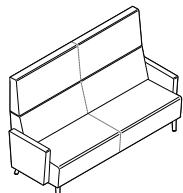

**Three Seater - Extended Back w/Arms**  
 COM Yardage: 11  
 Freight Class: 300  
 Product Weight (lbs.): 144  
 Cubic Feet Per Carton: 78.75

For Power/USB module please see electrical placement chart.  
 No ganging hardware.

MODEL#	1	2	3	4	5	6	7	8	9	10	11	12
7709	4645	4962	5214	5594	6131	6324	6793	7690	8122	8955	10086	11496

OVERALL DIMENSIONS			SEAT DIMENSIONS			BACK DIMENSIONS	
W	D	H	W	D	H	W	H
77.5	29.5	47	72	19	18	72	29

RTA 00

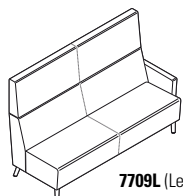

7709L (Left Arm)

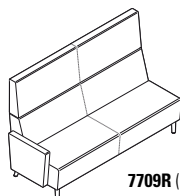

7709R (Right Arm)

**Three Seater - Extended Back w/One Arm**  
 COM Yardage: 10.50  
 Freight Class: 300  
 Product Weight (lbs.): 134  
 Cubic Feet Per Carton: 78.75

For Power/USB module please see electrical placement chart.  
 Includes ganging hardware (1 side).

MODEL#	1	2	3	4	5	6	7	8	9	10	11	12
7709L	4357	4660	4900	5263	5776	5959	6408	7264	7675	8470	9550	10896
7709R	4357	4660	4900	5263	5776	5959	6408	7264	7675	8470	9550	10896

OVERALL DIMENSIONS			SEAT DIMENSIONS			BACK DIMENSIONS	
W	D	H	W	D	H	W	H
75	29.5	47	72	19	18	72	29

RTA 00

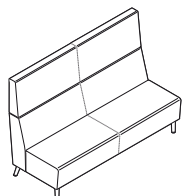

**Armless Three Seater - Extended Back**  
 COM Yardage: 9.75  
 Freight Class: 300  
 Product Weight (lbs.): 124  
 Cubic Feet Per Carton: 78.75

For Power/USB module please see electrical placement chart.  
 Includes ganging hardware (2 sides).

MODEL#	1	2	3	4	5	6	7	8	9	10	11	12
7709NA	4066	4346	4571	4906	5382	5553	5968	6765	7147	7885	8888	10139

OVERALL DIMENSIONS			SEAT DIMENSIONS			BACK DIMENSIONS	
W	D	H	W	D	H	W	H
72.5	29.5	47	72	19	18	72	29

RTA 00

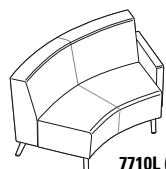

7710L (Left Arm)

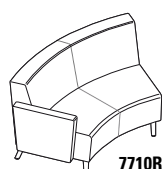

7710R (Right Arm)

**IS Curve - Two Seater - Standard Back w/One Arm**  
 COM Yardage: 5.25  
 Freight Class: 250  
 Product Weight (lbs.): 88  
 Cubic Feet Per Carton: 43

For Power/USB module please see electrical placement chart.  
 Includes ganging hardware (1 side).

MODEL#	1	2	3	4	5	6	7	8	9	10	11	12
7710L	2582	2735	2855	3036	3292	3384	3609	4036	4243	4640	5179	5853
7710R	2582	2735	2855	3036	3292	3384	3609	4036	4243	4640	5179	5853

OVERALL DIMENSIONS			SEAT DIMENSIONS			BACK DIMENSIONS	
W	D	H	W	D	H	W	H
57	29.5	32	42	19	18	51	14

RTA 00

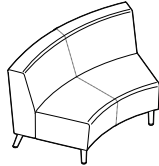
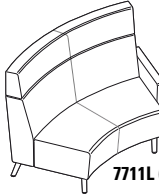
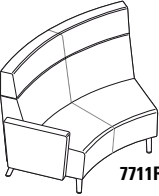
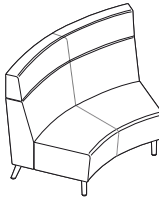
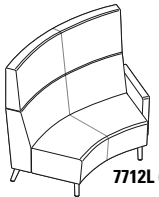
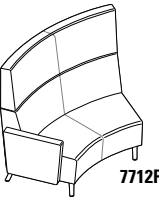
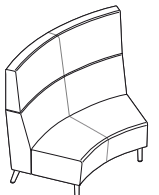
DESCRIPTION	FEATURES	MODEL#	STANDARD TEXTILE GRADES													
			1	2	3	4	5	6	7	8	9	10	11	12		
 <p><b>Armless IS Curve - Two Seat - Standard Back</b> COM Yardage: 4.50 Freight Class: 300 Product Weight (lbs.): 78 Cubic Feet Per Carton: 43</p>	<p>For Power/USB module please see electrical placement chart. Includes ganging hardware (2 sides).</p>	<b>7710NA</b>	2289	2419	2522	2678	2898	2976	3169	3535	3712	4053	4516	5092		
		<b>OVERALL DIMENSIONS</b>			<b>SEAT DIMENSIONS</b>			<b>BACK DIMENSIONS</b>								
		<b>W</b>	<b>D</b>	<b>H</b>	<b>W</b>	<b>D</b>	<b>H</b>	<b>W</b>	<b>H</b>							
			55	29.5	32	42	19	18	51	14						
			<b>RTA 00</b>													
 <p><b>7711L (Left Arm)</b></p>	 <p><b>7711R (Right Arm)</b></p>		1	2	3	4	5	6	7	8	9	10	11	12		
		<b>7711L</b>	3200	3387	3536	3760	4078	4192	4469	4999	5255	5746	6414	7249		
		<b>7711R</b>	3200	3387	3536	3760	4078	4192	4469	4999	5255	5746	6414	7249		
<b>OVERALL DIMENSIONS</b>			<b>SEAT DIMENSIONS</b>			<b>BACK DIMENSIONS</b>										
<b>W</b>	<b>D</b>	<b>H</b>	<b>W</b>	<b>D</b>	<b>H</b>	<b>W</b>	<b>H</b>									
			57	29.5	41.5	42	19	18	51	24						
			<b>RTA 00</b>													
 <p><b>Armless IS Curve - Two Seater - High Back</b> COM Yardage: 6 Freight Class: 300 Product Weight (lbs.): 84 Cubic Feet Per Carton: 54</p>	<p>For Power/USB module please see electrical placement chart. Includes ganging hardware (2 sides).</p>	<b>7711NA</b>	2907	3081	3219	3426	3719	3825	4080	4571	4804	5259	5876	6646		
		<b>OVERALL DIMENSIONS</b>			<b>SEAT DIMENSIONS</b>			<b>BACK DIMENSIONS</b>								
		<b>W</b>	<b>D</b>	<b>H</b>	<b>W</b>	<b>D</b>	<b>H</b>	<b>W</b>	<b>H</b>							
			55	29.5	41.5	42	19	18	51	24						
			<b>RTA 00</b>													
 <p><b>7712L (Left Arm)</b></p>	 <p><b>7712R (Right Arm)</b></p>		1	2	3	4	5	6	7	8	9	10	11	12		
		<b>7712L</b>	3491	3693	3854	4095	4437	4559	4858	5430	5704	6234	6954	7851		
		<b>7712R</b>	3491	3693	3854	4095	4437	4559	4858	5430	5704	6234	6954	7851		
<b>OVERALL DIMENSIONS</b>			<b>SEAT DIMENSIONS</b>			<b>BACK DIMENSIONS</b>										
<b>W</b>	<b>D</b>	<b>H</b>	<b>W</b>	<b>D</b>	<b>H</b>	<b>W</b>	<b>H</b>									
			57	29.5	47	42	19	18	51	29						
			<b>RTA 00</b>													
 <p><b>Armless IS Curve - Two Seater - Extended Back</b> COM Yardage: 6.75 Freight Class: 29.5 Product Weight (lbs.): 89 Cubic Feet Per Carton: 6.75</p>	<p>For Power/USB module please see electrical placement chart. Includes ganging hardware (2 sides).</p>	<b>7712NA</b>	3200	3394	3549	3782	4111	4230	4518	5068	5334	5845	6539	7403		
		<b>OVERALL DIMENSIONS</b>			<b>SEAT DIMENSIONS</b>			<b>BACK DIMENSIONS</b>								
		<b>W</b>	<b>D</b>	<b>H</b>	<b>W</b>	<b>D</b>	<b>H</b>	<b>W</b>	<b>H</b>							
			55	29.5	47	42	19	18	51	29						
			<b>RTA 00</b>													

DESCRIPTION FEATURES MODEL# STANDARD TEXTILE GRADES



7713L (Left Arm)

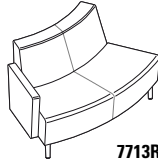

7713R (Right Arm)

**OS Curve - Two Seater - Standard Back w/One Arm**  
 COM Yardage: 5.25  
 Freight Class: 300  
 Product Weight (lbs.): 82  
 Cubic Feet Per Carton: 43

For Power/USB module please see electrical placement chart. Includes ganging hardware (1 side).

	1	2	3	4	5	6	7	8	9	10	11	12
<b>7713L</b>	2582	2735	2855	3036	3292	3384	3609	4036	4243	4640	5179	5853
<b>7713R</b>	2582	2735	2855	3036	3292	3384	3609	4036	4243	4640	5179	5853

OVERALL DIMENSIONS			SEAT DIMENSIONS			BACK DIMENSIONS	
W	D	H	W	D	H	W	H
54.5	29.5	32	48	19	18	36	14

RTA 00

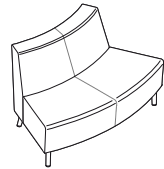

**Armless OS Curve - Two Seater - Standard Back**  
 COM Yardage: 4.50  
 Freight Class: 300  
 Product Weight (lbs.): 72  
 Cubic Feet Per Carton: 43

For Power/USB module please see electrical placement chart. Includes ganging hardware (2 sides).

	1	2	3	4	5	6	7	8	9	10	11	12
<b>7713NA</b>	2289	2419	2522	2678	2898	2976	3169	3535	3712	4053	4516	5092

OVERALL DIMENSIONS			SEAT DIMENSIONS			BACK DIMENSIONS	
W	D	H	W	D	H	W	H
54.	29.5	32	48	19	18	36	14

RTA 00

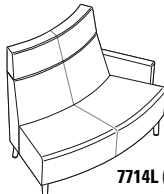

7714L (Left Arm)

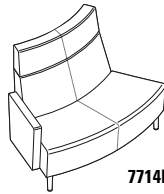

7714R (Right Arm)

**OS Curve - Two Seater - High Back w/One Arm**  
 COM Yardage: 6.50  
 Freight Class: 300  
 Product Weight (lbs.): 88  
 Cubic Feet Per Carton: 54

For Power/USB module please see electrical placement chart. Includes ganging hardware (1 side).

	1	2	3	4	5	6	7	8	9	10	11	12
<b>7714L</b>	3017	3207	3355	3580	3897	4011	4288	4818	5073	5566	6234	7067
<b>7714R</b>	3017	3207	3355	3580	3897	4011	4288	4818	5073	5566	6234	7067

OVERALL DIMENSIONS			SEAT DIMENSIONS			BACK DIMENSIONS	
W	D	H	W	D	H	W	H
54.5	29.5	41.5	48	19	18	36	24

RTA 00

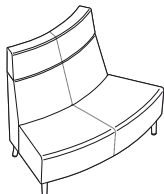

**Armless OS Curve - Two Seater - High Back**  
 COM Yardage: 6  
 Freight Class: 300  
 Product Weight (lbs.): 78  
 Cubic Feet Per Carton: 54

For Power/USB module please see electrical placement chart. Includes ganging hardware (2 sides).

	1	2	3	4	5	6	7	8	9	10	11	12
<b>7714NA</b>	2730	2903	3041	3248	3541	3647	3902	4391	4627	5081	5698	6468

OVERALL DIMENSIONS			SEAT DIMENSIONS			BACK DIMENSIONS	
W	D	H	W	D	H	W	H
54	29.5	41.5	48	19	18	36	24

RTA 00

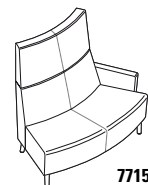

7715L (Left Arm)

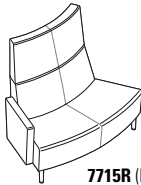

7715R (Right Arm)

**OS Curve - Two Seater - Extended Back w/One Arm**  
 COM Yardage: 7  
 Freight Class: 300  
 Product Weight (lbs.): 93  
 Cubic Feet Per Carton: 62.75

For Power/USB module please see electrical placement chart. Includes ganging hardware (1 side).

	1	2	3	4	5	6	7	8	9	10	11	12
<b>7715L</b>	3293	3496	3657	3899	4240	4363	4662	5233	5507	6037	6757	7654
<b>7715R</b>	3293	3496	3657	3899	4240	4363	4662	5233	5507	6037	6757	7654

OVERALL DIMENSIONS			SEAT DIMENSIONS			BACK DIMENSIONS	
W	D	H	W	D	H	W	H
54.5	29.5	47	48	19	18	36	29

RTA 00

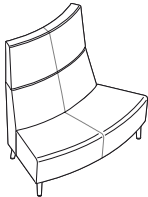
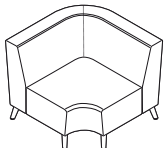
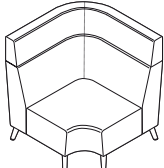
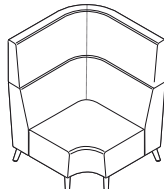
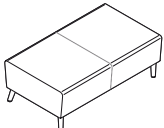
DESCRIPTION	FEATURES	MODEL#	STANDARD TEXTILE GRADES											
			1	2	3	4	5	6	7	8	9	10	11	12
 <p><b>Armless OS Curve - Two Seater - Ext. High Back</b>                      COM Yardage: 6.75                      Freight Class: 300                      Product Weight (lbs.): 83                      Cubic Feet Per Carton: 62.75</p>	For Power/USB module please see electrical placement chart. Includes ganging hardware (2 sides).	<b>7715NA</b>	3001	3196	3351	3583	3912	4031	4319	4870	5135	5646	6340	7205
			<b>OVERALL DIMENSIONS</b>			<b>SEAT DIMENSIONS</b>			<b>BACK DIMENSIONS</b>					
			<b>W</b>	<b>D</b>	<b>H</b>	<b>W</b>	<b>D</b>	<b>H</b>	<b>W</b>	<b>H</b>				
			54	29.5	47	48	19	18	36	28				
			<b>RTA 00</b>											
 <p><b>Armless Corner Unit - Standard Back</b>                      COM Yardage: 5.50                      Freight Class: 300                      Product Weight (lbs.): 75                      Cubic Feet Per Carton: 49</p>	For Power/USB module please see electrical placement chart. Includes ganging hardware (2 sides).	<b>7716</b>	2797	2957	3083	3273	3542	3637	3872	4321	4537	4954	5519	6224
			<b>OVERALL DIMENSIONS</b>			<b>SEAT DIMENSIONS</b>			<b>BACK DIMENSIONS</b>					
			<b>W</b>	<b>D</b>	<b>H</b>	<b>W</b>	<b>D</b>	<b>H</b>	<b>W</b>	<b>H</b>				
			38	38	32	24	19	18	24	14				
			<b>RTA 00</b>											
 <p><b>Armless Corner Unit - High Back</b>                      COM Yardage: 7.75                      Freight Class: 300                      Product Weight (lbs.): 82                      Cubic Feet Per Carton: 49</p>	For Power/USB module please see electrical placement chart. Includes ganging hardware (2 sides).	<b>7717</b>	3542	3764	3942	4210	4589	4724	5055	5687	5991	6578	7375	8368
			<b>OVERALL DIMENSIONS</b>			<b>SEAT DIMENSIONS</b>			<b>BACK DIMENSIONS</b>					
			<b>W</b>	<b>D</b>	<b>H</b>	<b>W</b>	<b>D</b>	<b>H</b>	<b>W</b>	<b>H</b>				
			38	38	41.5	24	19	18	24	24				
			<b>RTA 00</b>											
 <p><b>Armless Corner Unit - Extended Back</b>                      COM Yardage: 8.5                      Freight Class: 300                      Product Weight (lbs.): 88                      Cubic Feet Per Carton: 49</p>	For Power/USB module please see electrical placement chart. Includes ganging hardware (2 sides).	<b>7718</b>	3752	3996	4192	4484	4899	5049	5411	6104	6438	7082	7955	9046
			<b>OVERALL DIMENSIONS</b>			<b>SEAT DIMENSIONS</b>			<b>BACK DIMENSIONS</b>					
			<b>W</b>	<b>D</b>	<b>H</b>	<b>W</b>	<b>D</b>	<b>H</b>	<b>W</b>	<b>H</b>				
			38	38	47	24	19	18	24	29				
			<b>RTA 00</b>											
 <p><b>Two Seater Bench</b>                      COM Yardage: 2.25                      Freight Class: 300                      Product Weight (lbs.): 41                      Cubic Feet Per Carton: 21.25</p>	For Power/USB module please see electrical placement chart. Includes ganging hardware (2 sides).	<b>7725</b>	1430	1497	1549	1626	1736	1775	1871	2054	2143	2314	2545	2833
			<b>OVERALL DIMENSIONS</b>			<b>SEAT DIMENSIONS</b>			<b>BACK DIMENSIONS</b>					
			<b>W</b>	<b>D</b>	<b>H</b>	<b>W</b>	<b>D</b>	<b>H</b>	<b>W</b>	<b>H</b>				
			48.5	28	17.5									
			<b>RTA 00</b>											

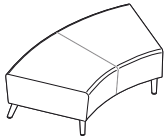
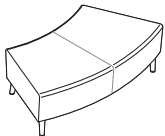
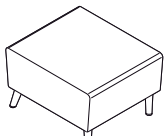
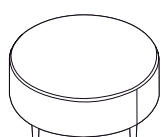
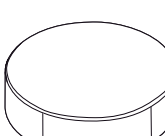
DESCRIPTION	FEATURES	MODEL#	STANDARD TEXTILE GRADES											
			1	2	3	4	5	6	7	8	9	10	11	12
 <b>IS Curve - Two Seater Bench</b> COM Yardage: 3 Freight Class: 300 Product Weight (lbs.): 41 Cubic Feet Per Carton: 21.25	For Power/USB module please see electrical placement chart. Includes ganging hardware (2 sides).	7726	1942	2030	2100	2202	2348	2401	2529	2774	2892	3119	3427	3813
			<b>OVERALL DIMENSIONS</b>			<b>SEAT DIMENSIONS</b>			<b>BACK DIMENSIONS</b>					
			<b>W</b>	<b>D</b>	<b>H</b>	<b>W</b>	<b>D</b>	<b>H</b>	<b>W</b>	<b>H</b>				
			54	28	17.5									
			<b>RTA 00</b>											
 <b>OS Curve - Two Seater Bench</b> COM Yardage: 3 Freight Class: 300 Product Weight (lbs.): 41 Cubic Feet Per Carton: 21.25	For Power/USB module please see electrical placement chart. Includes ganging hardware (2 sides).	7727	1942	2030	2100	2202	2348	2401	2529	2774	2892	3119	3427	3813
			<b>OVERALL DIMENSIONS</b>			<b>SEAT DIMENSIONS</b>			<b>BACK DIMENSIONS</b>					
			<b>W</b>	<b>D</b>	<b>H</b>	<b>W</b>	<b>D</b>	<b>H</b>	<b>W</b>	<b>H</b>				
			54	28	17.5									
			<b>RTA 00</b>											
 <b>Square Single Seater Bench</b> COM Yardage: 1.75 Freight Class: 250 Product Weight (lbs.): 30 Cubic Feet Per Carton: 9.25	No Power/USB module. Includes ganging hardware (2 sides).	7728	977	1027	1068	1128	1214	1245	1319	1462	1531	1663	1843	2068
			<b>OVERALL DIMENSIONS</b>			<b>SEAT DIMENSIONS</b>			<b>BACK DIMENSIONS</b>					
			<b>W</b>	<b>D</b>	<b>H</b>	<b>W</b>	<b>D</b>	<b>H</b>	<b>W</b>	<b>H</b>				
			24.5	28	17.5									
			<b>RTA 00</b>											
 <b>36" Dia. - Round Bench</b> COM Yardage: 3 Freight Class: 250 Product Weight (lbs.): 46 Cubic Feet Per Carton: 18.25	No Power/USB module. No ganging hardware.	7729	1435	1523	1593	1696	1842	1896	2023	2268	2386	2613	2921	3306
			<b>OVERALL DIMENSIONS</b>			<b>SEAT DIMENSIONS</b>			<b>BACK DIMENSIONS</b>					
			<b>W</b>	<b>D</b>	<b>H</b>	<b>W</b>	<b>D</b>	<b>H</b>	<b>W</b>	<b>H</b>				
			36	36	17.5									
			<b>RTA 00</b>											
 <b>42" Dia. - Round Bench</b> COM Yardage: 3.25 Freight Class: 250 Product Weight (lbs.): 50 Cubic Feet Per Carton: 22	No Power/USB module. No ganging hardware.	7730	1651	1744	1818	1932	2089	2146	2285	2551	2678	2924	3257	3675
			<b>OVERALL DIMENSIONS</b>			<b>SEAT DIMENSIONS</b>			<b>BACK DIMENSIONS</b>					
			<b>W</b>	<b>D</b>	<b>H</b>	<b>W</b>	<b>D</b>	<b>H</b>	<b>W</b>	<b>H</b>				
			42	42	17.5									
			<b>RTA 00</b>											

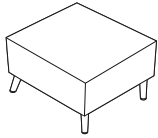
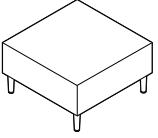
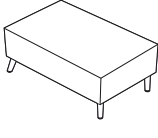
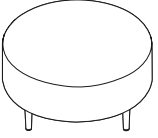
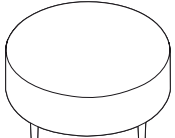
DESCRIPTION	FEATURES	MODEL#	STANDARD TEXTILE GRADES											
			1	2	3	4	5	6	7	8	9	10	11	12
 <p><b>30" Square Laminate Coffee Table</b> COM Yardage: N/A Freight Class: 150 Product Weight (lbs.): 61 Cubic Feet Per Carton: 11.50</p>	<p>For Power/USB module please see electrical placement chart. No ganging hardware.</p>	7731	912											
			<b>OVERALL DIMENSIONS</b>			<b>SEAT DIMENSIONS</b>			<b>BACK DIMENSIONS</b>					
			<b>W</b>	<b>D</b>	<b>H</b>	<b>W</b>	<b>D</b>	<b>H</b>	<b>W</b>	<b>H</b>				
			30	30	17									
			<b>RTA 00</b>											
 <p><b>36" Square Laminate Coffee Table</b> COM Yardage: N/A Freight Class: 150 Product Weight (lbs.): 85 Cubic Feet Per Carton: 16.50</p>	<p>For Power/USB module please see electrical placement chart. No ganging hardware.</p>	7732	1037											
			<b>OVERALL DIMENSIONS</b>			<b>SEAT DIMENSIONS</b>			<b>BACK DIMENSIONS</b>					
			<b>W</b>	<b>D</b>	<b>H</b>	<b>W</b>	<b>D</b>	<b>H</b>	<b>W</b>	<b>H</b>				
			36	36	17									
			<b>RTA 00</b>											
 <p><b>Rectangular Laminate Coffee Table</b> COM Yardage: N/A Freight Class: 150 Product Weight (lbs.): 55 Cubic Feet Per Carton: 11.50</p>	<p>For Power/USB module please see electrical placement chart. No ganging hardware.</p>	7733	917											
			<b>OVERALL DIMENSIONS</b>			<b>SEAT DIMENSIONS</b>			<b>BACK DIMENSIONS</b>					
			<b>W</b>	<b>D</b>	<b>H</b>	<b>W</b>	<b>D</b>	<b>H</b>	<b>W</b>	<b>H</b>				
			40	20	17									
			<b>RTA 00</b>											
 <p><b>36" Dia. - Round Laminate Coffee Table</b> COM Yardage: N/A Freight Class: 250 Product Weight (lbs.): 63 Cubic Feet Per Carton: 16.50</p>	<p>For Power/USB module please see electrical placement chart. No ganging hardware.</p>	7734	1132											
			<b>OVERALL DIMENSIONS</b>			<b>SEAT DIMENSIONS</b>			<b>BACK DIMENSIONS</b>					
			<b>W</b>	<b>D</b>	<b>H</b>	<b>W</b>	<b>D</b>	<b>H</b>	<b>W</b>	<b>H</b>				
			36	36	17									
			<b>RTA 00</b>											
 <p><b>42" Dia. - Round Laminate Coffee Table</b> COM Yardage: N/A Freight Class: 250 Product Weight (lbs.): 85 Cubic Feet Per Carton: 22</p>	<p>For Power/USB module please see electrical placement chart. No ganging hardware.</p>	7735	1238											
			<b>OVERALL DIMENSIONS</b>			<b>SEAT DIMENSIONS</b>			<b>BACK DIMENSIONS</b>					
			<b>W</b>	<b>D</b>	<b>H</b>	<b>W</b>	<b>D</b>	<b>H</b>	<b>W</b>	<b>H</b>				
			42	42	17									
			<b>RTA 00</b>											

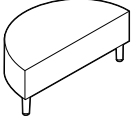
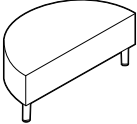
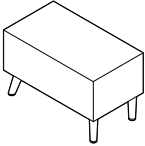
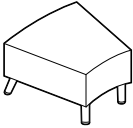
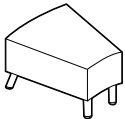

DESCRIPTION	FEATURES	MODEL#	STANDARD TEXTILE GRADES													
			1	2	3	4	5	6	7	8	9	10	11	12		
 <p><b>36" Half Round Laminate Coffee Table</b> COM Yardage: N/A Freight Class: 400 Product Weight (lbs.): 37 Cubic Feet Per Carton: 8.50</p>	<p>For Power/USB module please see electrical placement chart. No ganging hardware.</p>	7736	802													
			<b>OVERALL DIMENSIONS</b>			<b>SEAT DIMENSIONS</b>			<b>BACK DIMENSIONS</b>							
			<b>W</b>	<b>D</b>	<b>H</b>	<b>W</b>	<b>D</b>	<b>H</b>	<b>W</b>	<b>H</b>						
			36	18	17											
			<b>RTA 00</b>													
 <p><b>42" Half Round Laminate Coffee Table</b> COM Yardage: N/A Freight Class: 150 Product Weight (lbs.): 48 Cubic Feet Per Carton: 11.50</p>	<p>For Power/USB module please see electrical placement chart. No ganging hardware.</p>	7737	972													
			<b>OVERALL DIMENSIONS</b>			<b>SEAT DIMENSIONS</b>			<b>BACK DIMENSIONS</b>							
			<b>W</b>	<b>D</b>	<b>H</b>	<b>W</b>	<b>D</b>	<b>H</b>	<b>W</b>	<b>H</b>						
			42	21	17											
			<b>RTA 00</b>													
 <p><b>Rectangular Laminate End Table</b> COM Yardage: N/A Freight Class: 125 Product Weight (lbs.): 34 Cubic Feet Per Carton: 5.50</p>	<p>For Power/USB module please see electrical placement chart. Includes ganging hardware (2 sides).</p>	7738	919													
			<b>OVERALL DIMENSIONS</b>			<b>SEAT DIMENSIONS</b>			<b>BACK DIMENSIONS</b>							
			<b>W</b>	<b>D</b>	<b>H</b>	<b>W</b>	<b>D</b>	<b>H</b>	<b>W</b>	<b>H</b>						
			15	26.5	17											
			<b>RTA 00</b>													
 <p><b>IS Curve Wide Wedge Laminate End Table</b> COM Yardage: N/A Freight Class: 150 Product Weight (lbs.): 50 Cubic Feet Per Carton: 9.50</p>	<p>For Power/USB module please see electrical placement chart. Includes ganging hardware (2 sides).</p>	7739	1214													
			<b>OVERALL DIMENSIONS</b>			<b>SEAT DIMENSIONS</b>			<b>BACK DIMENSIONS</b>							
			<b>W</b>	<b>D</b>	<b>H</b>	<b>W</b>	<b>D</b>	<b>H</b>	<b>W</b>	<b>H</b>						
			27.25	26.5	17											
			<b>RTA 00</b>													
 <p><b>IS Curve Narrow Wedge Laminate End Table</b> COM Yardage: N/A Freight Class: 150 Product Weight (lbs.): 34 Cubic Feet Per Carton: 6.50</p>	<p>For Power/USB module please see electrical placement chart. Includes ganging hardware (2 sides).</p>	7740	982													
			<b>OVERALL DIMENSIONS</b>			<b>SEAT DIMENSIONS</b>			<b>BACK DIMENSIONS</b>							
			<b>W</b>	<b>D</b>	<b>H</b>	<b>W</b>	<b>D</b>	<b>H</b>	<b>W</b>	<b>H</b>						
			18.25	26.5	17											
			<b>RTA 00</b>													

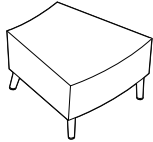
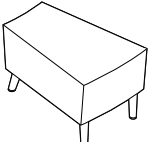
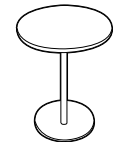
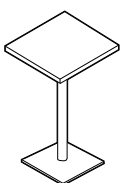
DESCRIPTION	FEATURES	MODEL#	STANDARD TEXTILE GRADES														
			1	2	3	4	5	6	7	8	9	10	11	12			
 <p><b>OS Curve - Wide Wedge Laminate End Table</b>                      COM Yardage: N/A                      Freight Class: 150                      Product Weight (lbs.): 50                      Cubic Feet Per Carton: 9.50</p>	For Power/USB module please see electrical placement chart. Includes ganging hardware (2 sides).	<b>7741</b> 1214															
			<b>OVERALL DIMENSIONS</b> W    D    H			<b>SEAT DIMENSIONS</b> W    D    H			<b>BACK DIMENSIONS</b> W    H								
			27.25   26.5   17														
			<b>RTA 00</b>														
 <p><b>OS Curve - Narrow Wedge Laminate End Table</b>                      COM Yardage: N/A                      Freight Class: 150                      Product Weight (lbs.): 34                      Cubic Feet Per Carton: 6.50</p>	For Power/USB module please see electrical placement chart. Includes ganging hardware (2 sides).	<b>7742</b> 982															
			<b>OVERALL DIMENSIONS</b> W    D    H			<b>SEAT DIMENSIONS</b> W    D    H			<b>BACK DIMENSIONS</b> W    H								
			18.25   26.5   17														
			<b>RTA 00</b>														
 <p><b>18" Dia. Round Laminate Laptop Table</b>                      COM Yardage: N/A                      Freight Class: 150                      Product Weight (lbs.): 32                      Cubic Feet Per Carton: 6</p>	No Power/USB module. No ganging hardware. Base only available in Black or Tungsten finish.	<b>7743</b> 556															
			<b>OVERALL DIMENSIONS</b> W    D    H			<b>SEAT DIMENSIONS</b> W    D    H			<b>BACK DIMENSIONS</b> W    H								
			18    18    25.25														
			<b>RTA 00</b>														
 <p><b>16" Square Laminate Laptop Table</b>                      COM Yardage: N/A                      Freight Class: 125                      Product Weight (lbs.): 36                      Cubic Feet Per Carton: 6</p>	No Power/USB module. No ganging hardware. Base only available in Black or Tungsten finish.	<b>7745</b> 544															
			<b>OVERALL DIMENSIONS</b> W    D    H			<b>SEAT DIMENSIONS</b> W    D    H			<b>BACK DIMENSIONS</b> W    H								
			16    16    25.25														
			<b>RTA 00</b>														

RIVER HIGH TRAFFIC



Sample Layout

STANDARD FEATURES

- River High Traffic models have all the same features and styling as River but are intended for High Traffic Applications. Please see series introduction page for more information.
- High Traffic (HT) units are rated at 350 lbs. active load per seat and 24/7 use. These units have the same puzzle box frame construction except that the framing wood is 1" thick, rotary cut, birch plywood and all arms, seat and back cushions are made with Ultracell Foam.
- High Traffic (HT) models are recommend to be specified in textiles that meet or exceed 100,000 double rubs for added abrasion performance.
- Not available in Silhouette fabric.

OPTIONAL FEATURES

- For series optional features please refer back to series introduction page.

DESCRIPTION	FEATURES	MODEL#	STANDARD TEXTILE GRADES											
-------------	----------	--------	-------------------------	--	--	--	--	--	--	--	--	--	--	--

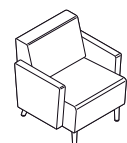

**Lounge Chair - Standard Back w/Arms**  
 COM Yardage: 4  
 Freight Class: 250  
 Product Weight (lbs.): 56  
 Cubic Feet Per Carton: 21.75

**High Traffic model**  
 For Power/USB module please see electrical placement chart.  
 No ganging hardware.

	1	2	3	4	5	6	7	8	9	10	11	12
<b>7751</b>	2058	2174	2265	2402	2598	2668	2838	3165	3322	3625	4036	4549

OVERALL DIMENSIONS			SEAT DIMENSIONS			BACK DIMENSIONS	
W	D	H	W	D	H	W	H

29.5	29.5	32	24	19	18	24	14
------	------	----	----	----	----	----	----

RTA 00

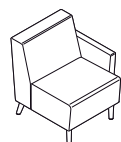

7751L (Left Arm)

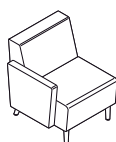

7751R (Right Arm)

**Lounge Chair - Standard w/One Arm**  
 COM Yardage: 3.25  
 Freight Class: 250  
 Product Weight (lbs.): 46  
 Cubic Feet Per Carton: 21.75

**High Traffic model**  
 For Power/USB module please see electrical placement chart.  
 Includes ganging hardware (1 side).

	1	2	3	4	5	6	7	8	9	10	11	12
<b>7751L</b>	1789	1882	1956	2069	2227	2284	2423	2688	2815	3062	3396	3813
Left Arm												
<b>7751R</b>	1789	1882	1956	2069	2227	2284	2423	2688	2815	3062	3396	3813
Right Arm												

OVERALL DIMENSIONS			SEAT DIMENSIONS			BACK DIMENSIONS	
W	D	H	W	D	H	W	H

27	29.5	32	24	19	18	24	14
----	------	----	----	----	----	----	----

RTA 00

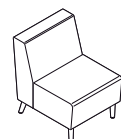

**Armless Lounge Chair - Standard Back**  
 COM Yardage: 2.50  
 Freight Class: 300  
 Product Weight (lbs.): 36  
 Cubic Feet Per Carton: 21.75

**High Traffic model**  
 For Power/USB module please see electrical placement chart.  
 Includes ganging hardware (2 sides).

	1	2	3	4	5	6	7	8	9	10	11	12
<b>7751NA</b>	1518	1590	1647	1734	1854	1900	2006	2210	2308	2497	2755	3074

OVERALL DIMENSIONS			SEAT DIMENSIONS			BACK DIMENSIONS	
W	D	H	W	D	H	W	H

24.5	29.5	32	24	19	18	24	14
------	------	----	----	----	----	----	----

RTA 00

DESCRIPTION	FEATURES	MODEL#	STANDARD TEXTILE GRADES											
-------------	----------	--------	-------------------------	--	--	--	--	--	--	--	--	--	--	--

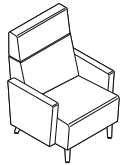

**Lounge Chair - High Back w/Arms**  
 COM Yardage: 4.50  
 Freight Class: 250  
 Product Weight (lbs.): 60  
 Cubic Feet Per Carton: 27.50

**High Traffic model**  
 For Power/USB module please see electrical placement chart.  
 No ganging hardware.

MODEL#	1	2	3	4	5	6	7	8	9	10	11	12
<b>7752</b>	2334	2465	2568	2724	2943	3023	3214	3581	3758	4099	4561	5138

OVERALL DIMENSIONS			SEAT DIMENSIONS			BACK DIMENSIONS	
W	D	H	W	D	H	W	H

29.5	29.5	41.5	24	19	18	24	24
------	------	------	----	----	----	----	----

RTA 00

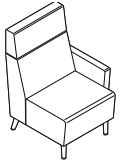

**7752L** (Left Arm)

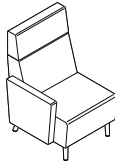

**7752R** (Right Arm)

**Lounge Chair - High Back w/One Arm**  
 COM Yardage: 4.50  
 Freight Class: 250  
 Product Weight (lbs.): 60  
 Cubic Feet Per Carton: 27.50

**High Traffic model**  
 For Power/USB module please see electrical placement chart.  
 Includes ganging hardware (1 side)

MODEL#	1	2	3	4	5	6	7	8	9	10	11	12
<b>7752L</b>	2064	2172	2258	2387	2570	2635	2796	3102	3249	3533	3919	4399

Left Arm												
<b>7752R</b>	2064	2172	2258	2387	2570	2635	2796	3102	3249	3533	3919	4399

OVERALL DIMENSIONS			SEAT DIMENSIONS			BACK DIMENSIONS	
W	D	H	W	D	H	W	H

29.5	29.5	41.5	24	19	18	24	24
------	------	------	----	----	----	----	----

RTA 00

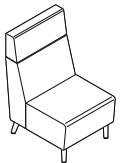

**Armless Lounge Chair - High Back**  
 COM Yardage: 3  
 Freight Class: 300  
 Product Weight (lbs.): 40  
 Cubic Feet Per Carton: 27.50

**High Traffic model**  
 For Power/USB module please see electrical placement chart.  
 Includes ganging hardware (2 sides).

MODEL#	1	2	3	4	5	6	7	8	9	10	11	12
<b>7752NA</b>	1794	1880	1949	2052	2199	2252	2380	2625	2742	2970	3278	3663

OVERALL DIMENSIONS			SEAT DIMENSIONS			BACK DIMENSIONS	
W	D	H	W	D	H	W	H

24.5	29.5	41.5	24	19	18	24	24
------	------	------	----	----	----	----	----

RTA 00

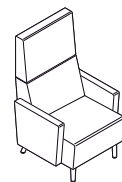

**Lounge Chair - Extended Back w/Arms**  
 COM Yardage: 4.75  
 Freight Class: 250  
 Product Weight (lbs.): 64  
 Cubic Feet Per Carton: 31.50

**High Traffic model**  
 For Power/USB module please see electrical placement chart.  
 No ganging hardware.

MODEL#	1	2	3	4	5	6	7	8	9	10	11	12
<b>7753</b>	2423	2559	2668	2832	3065	3147	3351	3738	3924	4284	4772	5381

OVERALL DIMENSIONS			SEAT DIMENSIONS			BACK DIMENSIONS	
W	D	H	W	D	H	W	H

29.5	29.5	47	24	19	18	24	29
------	------	----	----	----	----	----	----

RTA 00

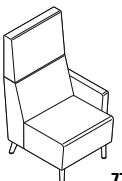

**7753L** (Left Arm)

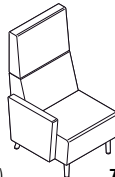

**7753R** (Right Arm)

**Lounge Chair - Extended Back w/One Arm**  
 COM Yardage: 3.25  
 Freight Class: 300  
 Product Weight (lbs.): 54  
 Cubic Feet Per Carton: 31.50

**High Traffic model**  
 For Power/USB module please see electrical placement chart.  
 Includes ganging hardware (1 side)

MODEL#	1	2	3	4	5	6	7	8	9	10	11	12
<b>7753L</b>	2152	2269	2360	2498	2693	2763	2935	3261	3417	3721	4131	4645

Left Arm												
<b>7753R</b>	2152	2269	2360	2498	2693	2763	2935	3261	3417	3721	4131	4645

OVERALL DIMENSIONS			SEAT DIMENSIONS			BACK DIMENSIONS	
W	D	H	W	D	H	W	H

29.5	29.5	47	24	19	18	24	29
------	------	----	----	----	----	----	----

RTA 00

DESCRIPTION FEATURES MODEL# STANDARD TEXTILE GRADES

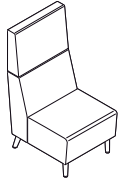

**Armless Lounge Chair - Extended Back**  
 COM Yardage: 3.25  
 Freight Class: 300  
 Product Weight (lbs.): 44  
 Cubic Feet Per Carton: 31.50

**High Traffic model**  
 For Power/USB module please see electrical placement chart.  
 Includes ganging hardware (2 sides).

MODEL#	1	2	3	4	5	6	7	8	9	10	11	12
7753NA	1882	1976	2050	2162	2321	2378	2517	2781	2909	3155	3489	3906

OVERALL DIMENSIONS			SEAT DIMENSIONS			BACK DIMENSIONS	
W	D	H	W	D	H	W	H
24.5	29.5	47	24	19	18	24	29

RTA 00

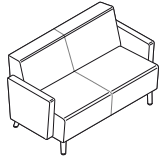

**Two Seater - Standard Back w/Arms**  
 COM Yardage: 5.50  
 Freight Class: 250  
 Product Weight (lbs.): 91  
 Cubic Feet Per Carton: 43

**High Traffic model**  
 For Power/USB module please see electrical placement chart.  
 No ganging hardware.

MODEL#	1	2	3	4	5	6	7	8	9	10	11	12
7754	2918	3078	3205	3394	3663	3759	3994	4443	4657	5074	5640	6345

OVERALL DIMENSIONS			SEAT DIMENSIONS			BACK DIMENSIONS	
W	D	H	W	D	H	W	H
53.5	29.5	32	48	19	18	48	14

RTA 00

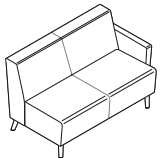

7754L (Left Arm)

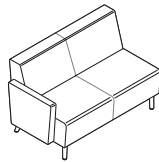

7754R (Right Arm)

**Two Seater - Standard Back w/One Arm**  
 COM Yardage: 4.75  
 Freight Class: 300  
 Product Weight (lbs.): 81  
 Cubic Feet Per Carton: 43

**High Traffic model**  
 For Power/USB module please see electrical placement chart.  
 Includes ganging hardware (1 side).

MODEL#	1	2	3	4	5	6	7	8	9	10	11	12
7754L	2649	2787	2896	3060	3291	3375	3578	3965	4151	4511	4999	5609
7754R	2649	2787	2896	3060	3291	3375	3578	3965	4151	4511	4999	5609

OVERALL DIMENSIONS			SEAT DIMENSIONS			BACK DIMENSIONS	
W	D	H	W	D	H	W	H
51	29.5	32	48	19	18	48	14

RTA 00

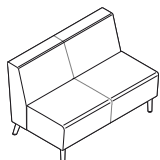

**Armless Two Seater - Standard Back**  
 COM Yardage: 4.25  
 Freight Class: 300  
 Product Weight (lbs.): 71  
 Cubic Feet Per Carton: 43

**High Traffic model**  
 For Power/USB module please see electrical placement chart.  
 Includes ganging hardware (2 sides).

MODEL#	1	2	3	4	5	6	7	8	9	10	11	12
7754NA	2378	2501	2599	2745	2954	3028	3209	3556	3722	4044	4481	5027

OVERALL DIMENSIONS			SEAT DIMENSIONS			BACK DIMENSIONS	
W	D	H	W	D	H	W	H
48.5	29.5	32	48	19	18	48	14

RTA 00

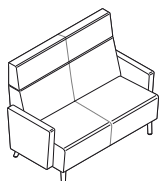

**Two Seater - High Back w/Arms**  
 COM Yardage: 6.50  
 Freight Class: 300  
 Product Weight (lbs.): 97  
 Cubic Feet Per Carton: 54

**High Traffic model**  
 For Power/USB module please see electrical placement chart.  
 No ganging hardware.

MODEL#	1	2	3	4	5	6	7	8	9	10	11	12
7755	3405	3591	3740	3964	4282	4396	4673	5203	5457	5950	6618	7453

OVERALL DIMENSIONS			SEAT DIMENSIONS			BACK DIMENSIONS	
W	D	H	W	D	H	W	H
53.5	29.5	41.5	48	19	18	48	24

RTA 00

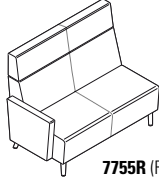
DESCRIPTION	FEATURES	MODEL#	STANDARD TEXTILE GRADES											
			1	2	3	4	5	6	7	8	9	10	11	12
 <p><b>7755L (Left Arm)</b></p>	 <p><b>7755R (Right Arm)</b></p>		1	2	3	4	5	6	7	8	9	10	11	12
			<p><b>7755L</b> Left Arm</p> <p><b>7755R</b> Right Arm</p>	3134	3301	3432	3631	3911	4012	4257	4726	4953	5388	5979
<p><b>Two Seater - High Back w/One Arm</b> COM Yardage: 5.75 Freight Class: 300 Product Weight (lbs.): 87 Cubic Feet Per Carton: 54</p>			<p><b>High Traffic model</b> For Power/USB module please see electrical placement chart. Includes ganging hardware (1 side).</p>			<p><b>OVERALL DIMENSIONS</b> W D H</p>			<p><b>SEAT DIMENSIONS</b> W D H</p>			<p><b>BACK DIMENSIONS</b> W H</p>		
			51	29.5	41.5	48	19	18	48	24				
			<b>RTA 00</b>											

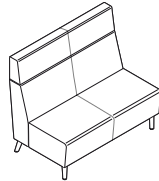
DESCRIPTION	FEATURES	MODEL#	STANDARD TEXTILE GRADES											
			1	2	3	4	5	6	7	8	9	10	11	12
			1	2	3	4	5	6	7	8	9	10	11	12
			<b>7755NA</b>	2864	3016	3137	3318	3575	3666	3890	4318	4524	4922	5463
<p><b>Armless Two Seater - High Back</b> COM Yardage: 5.25 Freight Class: 300 Product Weight (lbs.): 77 Cubic Feet Per Carton: 54</p>			<p><b>High Traffic model</b> For Power/USB module please see electrical placement chart. Includes ganging hardware (2 sides).</p>			<p><b>OVERALL DIMENSIONS</b> W D H</p>			<p><b>SEAT DIMENSIONS</b> W D H</p>			<p><b>BACK DIMENSIONS</b> W H</p>		
			48.5	29.5	41.5	48	19	18	48	24				
			<b>RTA 00</b>											

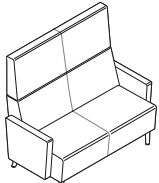
DESCRIPTION	FEATURES	MODEL#	STANDARD TEXTILE GRADES											
			1	2	3	4	5	6	7	8	9	10	11	12
			1	2	3	4	5	6	7	8	9	10	11	12
			<b>7756</b>	3591	3793	3954	4195	4537	4658	4958	5529	5802	6333	7053
<p><b>Two Seater - Extended Back w/Arms</b> COM Yardage: 7 Freight Class: 300 Product Weight (lbs.): 102 Cubic Feet Per Carton: 62.75</p>			<p><b>High Traffic model</b> For Power/USB module please see electrical placement chart. No ganging hardware.</p>			<p><b>OVERALL DIMENSIONS</b> W D H</p>			<p><b>SEAT DIMENSIONS</b> W D H</p>			<p><b>BACK DIMENSIONS</b> W H</p>		
			53.5	29.5	47	48	19	18	48	29				
			<b>RTA 00</b>											

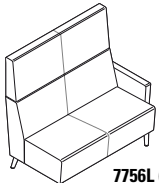
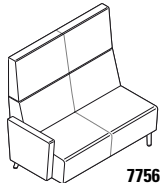
DESCRIPTION	FEATURES	MODEL#	STANDARD TEXTILE GRADES											
			1	2	3	4	5	6	7	8	9	10	11	12
 <p><b>7756L (Left Arm)</b></p>	 <p><b>7756R (Right Arm)</b></p>		1	2	3	4	5	6	7	8	9	10	11	12
			<p><b>7756L</b> Left Arm</p> <p><b>7756R</b> Right Arm</p>	3321	3501	3645	3861	4165	4275	4542	5052	5296	5771	6412
<p><b>Two Seater - Extended Back w/One Arm</b> COM Yardage: 6.25 Freight Class: 300 Product Weight (lbs.): 92 Cubic Feet Per Carton: 62.75</p>			<p><b>High Traffic model</b> For Power/USB module please see electrical placement chart. Includes ganging hardware (1 side).</p>			<p><b>OVERALL DIMENSIONS</b> W D H</p>			<p><b>SEAT DIMENSIONS</b> W D H</p>			<p><b>BACK DIMENSIONS</b> W H</p>		
			51	29.5	47	48	19	18	48	29				
			<b>RTA 00</b>											

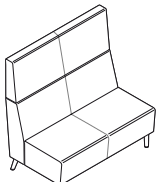
DESCRIPTION	FEATURES	MODEL#	STANDARD TEXTILE GRADES											
			1	2	3	4	5	6	7	8	9	10	11	12
			1	2	3	4	5	6	7	8	9	10	11	12
			<b>7756NA</b>	3050	3216	3348	3546	3827	3928	4173	4643	4868	5303	5894
<p><b>Armless Two Seater - Extended Back</b> COM Yardage: 5.75 Freight Class: 300 Product Weight (lbs.): 82 Cubic Feet Per Carton: 62.75</p>			<p><b>High Traffic model</b> For Power/USB module please see electrical placement chart. Includes ganging hardware (2 sides).</p>			<p><b>OVERALL DIMENSIONS</b> W D H</p>			<p><b>SEAT DIMENSIONS</b> W D H</p>			<p><b>BACK DIMENSIONS</b> W H</p>		
			48.5	29.5	47	48	19	18	48	29				
			<b>RTA 00</b>											

**DESCRIPTION      FEATURES      MODEL#      STANDARD TEXTILE GRADES**

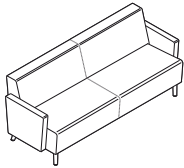

**Three Seater - Standard Back w/Arms**  
 COM Yardage: 8.25  
 Freight Class: 250  
 Product Weight (lbs.): 133  
 Cubic Feet Per Carton: 54

**High Traffic model**  
 For Power/USB module please see electrical placement chart.  
 No ganging hardware.

MODEL#	1	2	3	4	5	6	7	8	9	10	11	12
<b>7757</b>	4628	4866	5056	5341	5743	5888	6239	6913	7236	7860	8709	9767

OVERALL DIMENSIONS			SEAT DIMENSIONS			BACK DIMENSIONS	
W	D	H	W	D	H	W	H
77.5	29.5	32	72	19	18	72	14

**RTA 00**

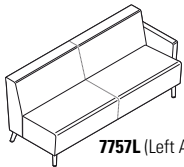

**7757L** (Left Arm)

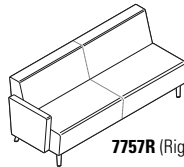

**7757R** (Right Arm)

**Three Seater - Standard Back w/One Arm**  
 COM Yardage: 7.75  
 Freight Class: 250  
 Product Weight (lbs.): 123  
 Cubic Feet Per Carton: 54

**High Traffic model**  
 For Power/USB module please see electrical placement chart.  
 Includes ganging hardware (1 side).

MODEL#	1	2	3	4	5	6	7	8	9	10	11	12
<b>7757L</b>	4357	4580	4758	5026	5404	5540	5870	6503	6806	7394	8191	9184

<b>7757R</b>	4357	4580	4758	5026	5404	5540	5870	6503	6806	7394	8191	9184
--------------	------	------	------	------	------	------	------	------	------	------	------	------

OVERALL DIMENSIONS			SEAT DIMENSIONS			BACK DIMENSIONS	
W	D	H	W	D	H	W	H
75	29.5	32	72	19	18	72	14

**RTA 00**

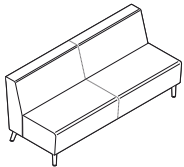

**Armless Three Seater - Standard Back**  
 COM Yardage: 7  
 Freight Class: 250  
 Product Weight (lbs.): 113  
 Cubic Feet Per Carton: 54

**High Traffic model**  
 For Power/USB module please see electrical placement chart.  
 Includes ganging hardware (2 sides).

MODEL#	1	2	3	4	5	6	7	8	9	10	11	12
<b>7757NA</b>	4088	4289	4451	4692	5034	5157	5455	6027	6301	6831	7550	8449

OVERALL DIMENSIONS			SEAT DIMENSIONS			BACK DIMENSIONS	
W	D	H	W	D	H	W	H
72.5	29.5	32	72	19	18	72	14

**RTA 00**

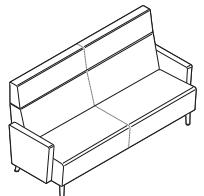

**Three Seater - High Back w/Arms**  
 COM Yardage: 10.50  
 Freight Class: 250  
 Product Weight (lbs.): 139  
 Cubic Feet Per Carton: 68

**High Traffic model**  
 For Power/USB module please see electrical placement chart.  
 No ganging hardware.

MODEL#	1	2	3	4	5	6	7	8	9	10	11	12
<b>7758</b>	5334	5636	5876	6238	6751	6935	7383	8239	8651	9447	10526	11872

OVERALL DIMENSIONS			SEAT DIMENSIONS			BACK DIMENSIONS	
W	D	H	W	D	H	W	H
77.5	29.5	41.5	72	19	18	72	24

**RTA 00**

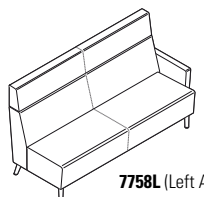

**7758L** (Left Arm)

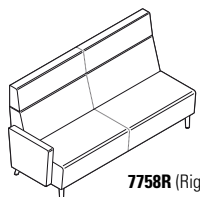

**7758R** (Right Arm)

**Three Seater - High Back w/One Arm**  
 COM Yardage: 9.75  
 Freight Class: 300  
 Product Weight (lbs.): 129  
 Cubic Feet Per Carton: 68

**High Traffic model**  
 For Power/USB module please see electrical placement chart.  
 Includes ganging hardware (1 side).

MODEL#	1	2	3	4	5	6	7	8	9	10	11	12
<b>7758L</b> Left Arm	5069	5350	5575	5911	6386	6559	6975	7769	8151	8889	9893	11143

<b>7758R</b> Right Arm	5069	5350	5575	5911	6386	6559	6975	7769	8151	8889	9893	11143
---------------------------	------	------	------	------	------	------	------	------	------	------	------	-------

OVERALL DIMENSIONS			SEAT DIMENSIONS			BACK DIMENSIONS	
W	D	H	W	D	H	W	H
75	29.5	41.5	72	19	18	72	24

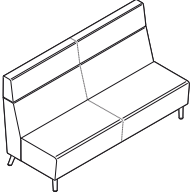

**RTA 00**

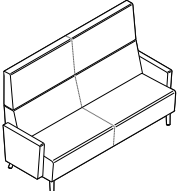
DESCRIPTION	FEATURES	MODEL#	STANDARD TEXTILE GRADES											
			1	2	3	4	5	6	7	8	9	10	11	12
 <p><b>Armless Three Seater - High Back</b> COM Yardage: 9.25 Freight Class: 300 Product Weight (lbs.): 119 Cubic Feet Per Carton: 68</p>	<p><b>High Traffic model</b> For Power/USB module please see electrical placement chart. Includes ganging hardware (2 sides).</p>	<b>7758NA</b>	4798	5065	5276	5596	6048	6210	6604	7359	7722	8422	9373	10560
		<b>OVERALL DIMENSIONS</b>			<b>SEAT DIMENSIONS</b>			<b>BACK DIMENSIONS</b>						
		<b>W</b>	<b>D</b>	<b>H</b>	<b>W</b>	<b>D</b>	<b>H</b>	<b>W</b>	<b>H</b>					
			72.5	29.5	41.5	72	19	18	72	24				
			<b>RTA 00</b>											

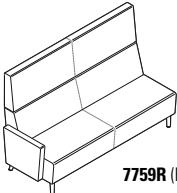
DESCRIPTION	FEATURES	MODEL#	STANDARD TEXTILE GRADES											
			1	2	3	4	5	6	7	8	9	10	11	12
 <p><b>Three Seater - Extended Back w/Arms</b> COM Yardage: 11 Freight Class: 300 Product Weight (lbs.): 144 Cubic Feet Per Carton: 78.75</p>	<p><b>High Traffic model</b> For Power/USB module please see electrical placement chart. No ganging hardware.</p>	<b>7759</b>	5548	5865	6118	6497	7033	7227	7696	8594	9024	9858	10989	12400
		<b>OVERALL DIMENSIONS</b>			<b>SEAT DIMENSIONS</b>			<b>BACK DIMENSIONS</b>						
		<b>W</b>	<b>D</b>	<b>H</b>	<b>W</b>	<b>D</b>	<b>H</b>	<b>W</b>	<b>H</b>					
			77.5	29.5	47	72	19	18	72	29				
			<b>RTA 00</b>											

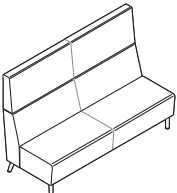

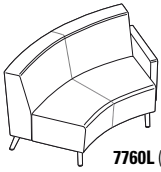
DESCRIPTION	FEATURES	MODEL#	STANDARD TEXTILE GRADES											
			1	2	3	4	5	6	7	8	9	10	11	12
 <p><b>7759L (Left Arm)</b></p>	 <p><b>7759R (Right Arm)</b></p>	<b>7759L</b>	5279	5582	5823	6185	6699	6882	7330	8186	8598	9393	10473	11820
		<b>OVERALL DIMENSIONS</b>			<b>SEAT DIMENSIONS</b>			<b>BACK DIMENSIONS</b>						
		<b>W</b>	<b>D</b>	<b>H</b>	<b>W</b>	<b>D</b>	<b>H</b>	<b>W</b>	<b>H</b>					
			75	29.5	47	72	19	18	72	29				
			<b>RTA 00</b>											

DESCRIPTION	FEATURES	MODEL#	STANDARD TEXTILE GRADES											
			1	2	3	4	5	6	7	8	9	10	11	12
 <p><b>Armless Three Seater - Extended Back</b> COM Yardage: 9.75 Freight Class: 300 Product Weight (lbs.): 124 Cubic Feet Per Carton: 78.75</p>	<p><b>High Traffic model</b> For Power/USB module please see electrical placement chart. Includes ganging hardware (2 sides).</p>	<b>7759NA</b>	5008	5289	5512	5849	6325	6495	6911	7707	8089	8828	9831	11080
		<b>OVERALL DIMENSIONS</b>			<b>SEAT DIMENSIONS</b>			<b>BACK DIMENSIONS</b>						
		<b>W</b>	<b>D</b>	<b>H</b>	<b>W</b>	<b>D</b>	<b>H</b>	<b>W</b>	<b>H</b>					
			72.5	29.5	47	72	19	18	72	29				
			<b>RTA 00</b>											

DESCRIPTION	FEATURES	MODEL#	STANDARD TEXTILE GRADES											
			1	2	3	4	5	6	7	8	9	10	11	12
 <p><b>7760L (Left Arm)</b></p>	 <p><b>7760R (Right Arm)</b></p>	<b>7760L</b>	3134	3286	3407	3588	3844	3936	4160	4589	4794	5192	5731	6404
		<b>OVERALL DIMENSIONS</b>			<b>SEAT DIMENSIONS</b>			<b>BACK DIMENSIONS</b>						
		<b>W</b>	<b>D</b>	<b>H</b>	<b>W</b>	<b>D</b>	<b>H</b>	<b>W</b>	<b>H</b>					
			57	29.5	32	42	19	18	51	14				
			<b>RTA 00</b>											



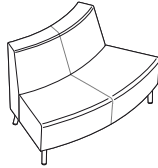
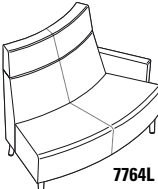
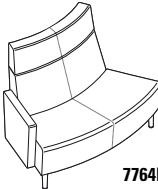
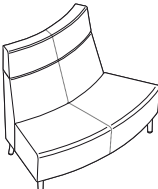
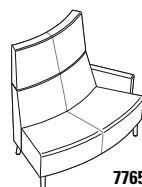
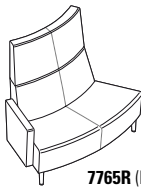

DESCRIPTION		FEATURES	MODEL#	STANDARD TEXTILE GRADES																																					
				1	2	3	4	5	6	7	8	9	10	11	12																										
 <p><b>7763L</b> (Left Arm)</p>	 <p><b>7763R</b> (Right Arm)</p>	<p><b>OS Curve - Two Seater - Standard Back w/One Arm</b> COM Yardage: 5.25 Freight Class: 300 Product Weight (lbs.): 82 Cubic Feet Per Carton: 43</p>	<p><b>High Traffic model</b> For Power/USB module please see electrical placement chart. Includes ganging hardware (1 side).</p>	<table border="1"> <tr> <td><b>7763L</b> Left Arm</td> <td>3134</td> <td>3286</td> <td>3407</td> <td>3588</td> <td>3844</td> <td>3936</td> <td>4160</td> <td>4589</td> <td>4794</td> <td>5192</td> <td>5731</td> <td>6404</td> </tr> <tr> <td><b>7763R</b> Right Arm</td> <td>3134</td> <td>3286</td> <td>3407</td> <td>3588</td> <td>3844</td> <td>3936</td> <td>4160</td> <td>4589</td> <td>4794</td> <td>5192</td> <td>5731</td> <td>6404</td> </tr> </table>												<b>7763L</b> Left Arm	3134	3286	3407	3588	3844	3936	4160	4589	4794	5192	5731	6404	<b>7763R</b> Right Arm	3134	3286	3407	3588	3844	3936	4160	4589	4794	5192	5731	6404
				<b>7763L</b> Left Arm	3134	3286	3407	3588	3844	3936	4160	4589	4794	5192	5731	6404																									
<b>7763R</b> Right Arm	3134	3286	3407	3588	3844	3936	4160	4589	4794	5192	5731	6404																													
				<b>OVERALL DIMENSIONS</b>			<b>SEAT DIMENSIONS</b>			<b>BACK DIMENSIONS</b>																															
				<b>W</b>	<b>D</b>	<b>H</b>	<b>W</b>	<b>D</b>	<b>H</b>	<b>W</b>	<b>H</b>																														
				54.5	29.5	32	48	19	18	36	14																														
				<b>RTA 00</b>																																					
			<table border="1"> <tr> <td><b>7763NA</b></td> <td>2864</td> <td>2995</td> <td>3099</td> <td>3253</td> <td>3473</td> <td>3552</td> <td>3744</td> <td>4110</td> <td>4287</td> <td>4628</td> <td>5091</td> <td>5668</td> </tr> </table>												<b>7763NA</b>	2864	2995	3099	3253	3473	3552	3744	4110	4287	4628	5091	5668														
	<b>7763NA</b>	2864	2995	3099	3253	3473	3552	3744	4110	4287	4628	5091	5668																												
				<b>OVERALL DIMENSIONS</b>			<b>SEAT DIMENSIONS</b>			<b>BACK DIMENSIONS</b>																															
				<b>W</b>	<b>D</b>	<b>H</b>	<b>W</b>	<b>D</b>	<b>H</b>	<b>W</b>	<b>H</b>																														
				54	29.5	32	48	19	18	36	14																														
				<b>RTA 00</b>																																					
 <p><b>7764L</b> (Left Arm)</p>	 <p><b>7764R</b> (Right Arm)</p>	<p><b>OS Curve - Two Seater - High Back w/One Arm</b> COM Yardage: 6.50 Freight Class: 300 Product Weight (lbs.): 88 Cubic Feet Per Carton: 54</p>	<p><b>High Traffic model</b> For Power/USB module please see electrical placement chart. Includes ganging hardware (1 side).</p>	<table border="1"> <tr> <td><b>7764L</b> Left Arm</td> <td>3585</td> <td>3772</td> <td>3922</td> <td>4145</td> <td>4463</td> <td>4577</td> <td>4854</td> <td>5384</td> <td>5640</td> <td>6131</td> <td>6800</td> <td>7634</td> </tr> <tr> <td><b>7764R</b> Right Arm</td> <td>3585</td> <td>3772</td> <td>3922</td> <td>4145</td> <td>4463</td> <td>4577</td> <td>4854</td> <td>5384</td> <td>5640</td> <td>6131</td> <td>6800</td> <td>7634</td> </tr> </table>												<b>7764L</b> Left Arm	3585	3772	3922	4145	4463	4577	4854	5384	5640	6131	6800	7634	<b>7764R</b> Right Arm	3585	3772	3922	4145	4463	4577	4854	5384	5640	6131	6800	7634
				<b>7764L</b> Left Arm	3585	3772	3922	4145	4463	4577	4854	5384	5640	6131	6800	7634																									
<b>7764R</b> Right Arm	3585	3772	3922	4145	4463	4577	4854	5384	5640	6131	6800	7634																													
				<b>OVERALL DIMENSIONS</b>			<b>SEAT DIMENSIONS</b>			<b>BACK DIMENSIONS</b>																															
				<b>W</b>	<b>D</b>	<b>H</b>	<b>W</b>	<b>D</b>	<b>H</b>	<b>W</b>	<b>H</b>																														
				54.5	29.5	41.5	48	19	18	36	24																														
				<b>RTA 00</b>																																					
			<table border="1"> <tr> <td><b>7764NA</b></td> <td>3316</td> <td>3488</td> <td>3626</td> <td>3833</td> <td>4126</td> <td>4232</td> <td>4487</td> <td>4976</td> <td>5212</td> <td>5667</td> <td>6283</td> <td>7053</td> </tr> </table>												<b>7764NA</b>	3316	3488	3626	3833	4126	4232	4487	4976	5212	5667	6283	7053														
	<b>7764NA</b>	3316	3488	3626	3833	4126	4232	4487	4976	5212	5667	6283	7053																												
				<b>OVERALL DIMENSIONS</b>			<b>SEAT DIMENSIONS</b>			<b>BACK DIMENSIONS</b>																															
				<b>W</b>	<b>D</b>	<b>H</b>	<b>W</b>	<b>D</b>	<b>H</b>	<b>W</b>	<b>H</b>																														
				54	29.5	41.5	48	19	18	36	24																														
				<b>RTA 00</b>																																					
 <p><b>7765L</b> (Left Arm)</p>	 <p><b>7765R</b> (Right Arm)</p>	<p><b>OS Curve - Two Seater - Extended Back w/One Arm</b> COM Yardage: 7 Freight Class: 300 Product Weight (lbs.): 93 Cubic Feet Per Carton: 62.75</p>	<p><b>High Traffic model</b> For Power/USB module please see electrical placement chart. Includes ganging hardware (1 side).</p>	<table border="1"> <tr> <td><b>7765L</b> Left Arm</td> <td>3872</td> <td>4074</td> <td>4236</td> <td>4477</td> <td>4819</td> <td>4941</td> <td>5240</td> <td>5812</td> <td>6086</td> <td>6615</td> <td>7336</td> <td>8233</td> </tr> <tr> <td><b>7765R</b> Right Arm</td> <td>3872</td> <td>4074</td> <td>4236</td> <td>4477</td> <td>4819</td> <td>4941</td> <td>5240</td> <td>5812</td> <td>6086</td> <td>6615</td> <td>7336</td> <td>8233</td> </tr> </table>												<b>7765L</b> Left Arm	3872	4074	4236	4477	4819	4941	5240	5812	6086	6615	7336	8233	<b>7765R</b> Right Arm	3872	4074	4236	4477	4819	4941	5240	5812	6086	6615	7336	8233
				<b>7765L</b> Left Arm	3872	4074	4236	4477	4819	4941	5240	5812	6086	6615	7336	8233																									
<b>7765R</b> Right Arm	3872	4074	4236	4477	4819	4941	5240	5812	6086	6615	7336	8233																													
				<b>OVERALL DIMENSIONS</b>			<b>SEAT DIMENSIONS</b>			<b>BACK DIMENSIONS</b>																															
				<b>W</b>	<b>D</b>	<b>H</b>	<b>W</b>	<b>D</b>	<b>H</b>	<b>W</b>	<b>H</b>																														
				54.5	29.5	47	48	19	18	36	29																														
				<b>RTA 00</b>																																					

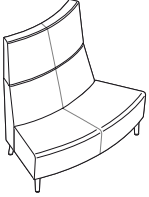
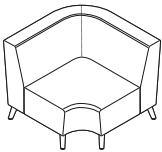
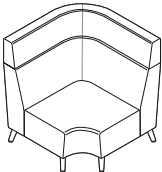
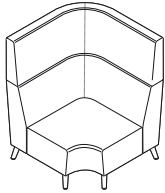
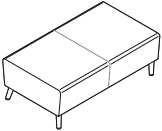
DESCRIPTION	FEATURES	MODEL#	STANDARD TEXTILE GRADES												
			1	2	3	4	5	6	7	8	9	10	11	12	
 <p><b>Armless OS Curve - Two Seater - Extended High Back</b>                      COM Yardage: 6.75                      Freight Class: 300                      Product Weight (lbs.): 83                      Cubic Feet Per Carton: 62.75</p>	<p><b>High Traffic model</b>                      For Power/USB module please see electrical placement chart.                      Includes ganging hardware (2 sides).</p>	<p><b>7765NA</b></p>	3601	3796	3952	4183	4513	4631	4920	5471	5736	6246	6941	7806	
			<b>OVERALL DIMENSIONS</b>			<b>SEAT DIMENSIONS</b>			<b>BACK DIMENSIONS</b>						
			<b>W</b>	<b>D</b>	<b>H</b>	<b>W</b>	<b>D</b>	<b>H</b>	<b>W</b>	<b>H</b>					
			54	29.5	47	48	19	18	36	28					
			<b>RTA 00</b>												
 <p><b>Armless Corner Unit - Standard Back</b>                      COM Yardage: 5.50                      Freight Class: 300                      Product Weight (lbs.): 75                      Cubic Feet Per Carton: 49</p>	<p><b>High Traffic model</b>                      For Power/USB module please see electrical placement chart.                      Includes ganging hardware (2 sides).</p>	<p><b>7766</b></p>	3601	3760	3887	4076	4344	4442	4676	5125	5340	5757	6323	7028	
			<b>OVERALL DIMENSIONS</b>			<b>SEAT DIMENSIONS</b>			<b>BACK DIMENSIONS</b>						
			<b>W</b>	<b>D</b>	<b>H</b>	<b>W</b>	<b>D</b>	<b>H</b>	<b>W</b>	<b>H</b>					
			38	38	32	24	19	18	24	14					
			<b>RTA 00</b>												
 <p><b>Armless Corner Unit - High Back</b>                      COM Yardage: 7.75                      Freight Class: 300                      Product Weight (lbs.): 82                      Cubic Feet Per Carton: 49</p>	<p><b>High Traffic model</b>                      For Power/USB module please see electrical placement chart.                      Includes ganging hardware (2 sides).</p>	<p><b>7767</b></p>	4566	4790	4967	5235	5613	5749	6081	6712	7016	7603	8400	9394	
			<b>OVERALL DIMENSIONS</b>			<b>SEAT DIMENSIONS</b>			<b>BACK DIMENSIONS</b>						
			<b>W</b>	<b>D</b>	<b>H</b>	<b>W</b>	<b>D</b>	<b>H</b>	<b>W</b>	<b>H</b>					
			38	38	41.5	24	19	18	24	24					
			<b>RTA 00</b>												
 <p><b>Armless Corner Unit - Extended Back</b>                      COM Yardage: 8.5                      Freight Class: 300                      Product Weight (lbs.): 88                      Cubic Feet Per Carton: 49</p>	<p><b>High Traffic model</b>                      For Power/USB module please see electrical placement chart.                      Includes ganging hardware (2 sides).</p>	<p><b>7768</b></p>	5074	5320	5516	5810	6224	6373	6736	7429	7763	8405	9280	10370	
			<b>OVERALL DIMENSIONS</b>			<b>SEAT DIMENSIONS</b>			<b>BACK DIMENSIONS</b>						
			<b>W</b>	<b>D</b>	<b>H</b>	<b>W</b>	<b>D</b>	<b>H</b>	<b>W</b>	<b>H</b>					
			38	38	47	24	19	18	24	29					
			<b>RTA 00</b>												
 <p><b>Two Seater Bench</b>                      COM Yardage: 2.25                      Freight Class: 300                      Product Weight (lbs.): 41                      Cubic Feet Per Carton: 21.25</p>	<p><b>High Traffic model</b>                      For Power/USB module please see electrical placement chart.                      Includes ganging hardware (2 sides).</p>	<p><b>7775</b></p>	1761	1827	1878	1955	2066	2105	2201	2384	2472	2643	2874	3163	
			<b>OVERALL DIMENSIONS</b>			<b>SEAT DIMENSIONS</b>			<b>BACK DIMENSIONS</b>						
			<b>W</b>	<b>D</b>	<b>H</b>	<b>W</b>	<b>D</b>	<b>H</b>	<b>W</b>	<b>H</b>					
			48.5	28	17.5										
			<b>RTA 00</b>												

DESCRIPTION	FEATURES	MODEL#	STANDARD TEXTILE GRADES											
-------------	----------	--------	-------------------------	--	--	--	--	--	--	--	--	--	--	--

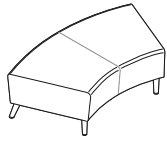

**IS Curve - Two Seater Bench**  
 COM Yardage: 3  
 Freight Class: 300  
 Product Weight (lbs.): 41  
 Cubic Feet Per Carton: 21.25

**High Traffic model**  
 For Power/USB module please see electrical placement chart.  
 Includes ganging hardware (2 sides).

MODEL#	1	2	3	4	5	6	7	8	9	10	11	12
7776	2544	2631	2700	2804	2950	3003	3132	3376	3493	3721	4029	4414

OVERALL DIMENSIONS			SEAT DIMENSIONS			BACK DIMENSIONS	
W	D	H	W	D	H	W	H
54	28	17.5					
<b>RTA 00</b>							

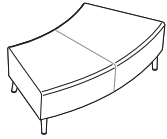

**OS Curve - Two Seater Bench**  
 COM Yardage: 3  
 Freight Class: 300  
 Product Weight (lbs.): 41  
 Cubic Feet Per Carton: 21.25

**High Traffic model**  
 For Power/USB module please see electrical placement chart.  
 Includes ganging hardware (2 sides).

MODEL#	1	2	3	4	5	6	7	8	9	10	11	12
7777	2544	2631	2700	2804	2950	3003	3132	3376	3493	3721	4029	4414

OVERALL DIMENSIONS			SEAT DIMENSIONS			BACK DIMENSIONS	
W	D	H	W	D	H	W	H
54	28	17.5					
<b>RTA 00</b>							

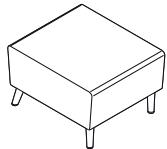

**Square Single Seater Bench**  
 COM Yardage: 1.75  
 Freight Class: 250  
 Product Weight (lbs.): 30  
 Cubic Feet Per Carton: 9.25

**High Traffic model**  
 No Power/USB module.  
 Includes ganging hardware (2 sides).

MODEL#	1	2	3	4	5	6	7	8	9	10	11	12
7778	1138	1188	1228	1289	1375	1405	1480	1623	1691	1824	2004	2228

OVERALL DIMENSIONS			SEAT DIMENSIONS			BACK DIMENSIONS	
W	D	H	W	D	H	W	H
24.5	28	17.5					
<b>RTA 00</b>							

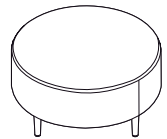

**36" Dia. - Round Bench**  
 COM Yardage: 3  
 Freight Class: 250  
 Product Weight (lbs.): 46  
 Cubic Feet Per Carton: 18.25

**High Traffic model**  
 No Power/USB module.  
 No ganging hardware.

MODEL#	1	2	3	4	5	6	7	8	9	10	11	12
7779	1518	1604	1672	1776	1922	1975	2104	2348	2466	2693	3001	3387

OVERALL DIMENSIONS			SEAT DIMENSIONS			BACK DIMENSIONS	
W	D	H	W	D	H	W	H
36	36	17.5					
<b>RTA 00</b>							

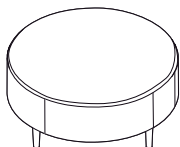

**42" Dia. - Round Bench**  
 COM Yardage: 3.25  
 Freight Class: 250  
 Product Weight (lbs.): 50  
 Cubic Feet Per Carton: 22

**High Traffic model**  
 No Power/USB module.  
 No ganging hardware.

MODEL#	1	2	3	4	5	6	7	8	9	10	11	12
7780	1777	1871	1945	2058	2216	2273	2412	2677	2805	3050	3384	3801

OVERALL DIMENSIONS			SEAT DIMENSIONS			BACK DIMENSIONS	
W	D	H	W	D	H	W	H
42	42	17.5					
<b>RTA 00</b>							

RIVER™ PERSONAL HARBOR



Sample Layout

ELECTRICAL PLACEMENT

Locations available on left side J1 (black) or W1 (white), right side J3 (black) or W3 (white) or both sides J1/J3 (black) or W1/W3 (white).

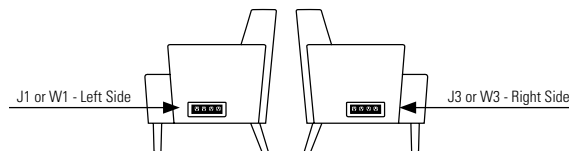

Personal Harbor - power module is located left or right of the seat box

STANDARD FEATURES

- River Personal Harbor is a line extension of the popular River modular seating series. For modular series see River price book pages.
- The freestanding soft seating models are available with standard height, high and extended high backs.
- The unique tapered legs (swaged legs) are made of welded steel, heavy duty construction, with each leg bolted directly to the frame. The extremely robust construction insures trouble free performance in any environment. All units have the same leg height of 6.5". The leg height makes it easier to clean under the product.
- Each leg is standard with adjustable black leveling glides and are non-marking. Wood legs and casters are not available.
- All cushions are fixed and non-removable (cushions will not migrate). Perimeter seams feature a decorative single stitch detail, which makes seams lay flat and adds extra seam strength.
- Seating frames are heavy duty with interlocking plywood, puzzle box construction, made for rugged active environments. Seats are high density with highly resilient foam and are equipped with a synthetic rubberized webbing suspension system for extra comfort.
- Front edge or face of the seat, angles slightly inward, so feet have freedom of movement and shoe heels don't rub on the seat. This inward slanting matches the inward angles of the back. Benches and connecting end tables also reflect the inward angles on the front and back faces, so all units coordinate in visual appearance.
- High Traffic (HT) units are rated at 350 lbs. active load per seat and 24/7 use. These units have the same puzzle box frame construction except that the framing wood is 1" thick, rotary cut, birch plywood and all arms, seat and back cushions are made with Ultracell Foam.

- High Traffic (HT) models are recommend to be specified in textiles that meet or exceed 100,000 double rubs for added abrasion performance.

OPTIONAL FEATURES

- Seating units can be specified with Power/USB terminals, which includes two power outlets, two double USB terminals and a black 60" three-prong power cord. Each Power/USB module is set in predetermined locations, as shown in the electrical illustrations below. Electrical units must be factory installed.
- To add a Power/USB module: From the electrical illustrations below, please specify **J1, W1, J2, W2, J3, W4, J4, W4, J6 or W6** after the product model number. Please note on seating units, if both right and left locations are required, add both **J1/J3 or W1/W3** to the model number. Add \$695 for each module/location required.
- Power/USB modules are available with either Jet Black (**J**) face plate with black Power/USB receptacles or with a White (**W**) face plate with white Power/USB receptacles.
- The metal legs are standard in Chrome (CHR). Tungsten (**TUN**) and Black (**BLK**) finishes are also available at no up charge. Laptop tables bases are only available in Tungsten (**TUN**) and Black (**BLK**) finishes.
- All models are available in fabric or vinyl. Not available in Crescent or Silhouette fabric. Leather upholstery is available upon special request and is only recommended for seat use. If more than one fabric or a fabric/vinyl leather combination is required, please fill out a "Seating Multiple Textile" form, specifying each fabric location. Please contact Customer Care for more information.

DESCRIPTION

FEATURES

MODEL#

STANDARD TEXTILE GRADES

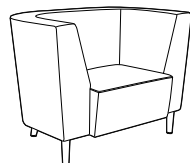

**Personal Harbor - Standard Back**  
COM Yardage: 5.5  
Freight Class: 150  
Product Weight (lbs.): 70  
Cubic Feet Per Carton: 31.75

For Power/USB module please see electrical placement chart. Freestanding unit only.

	1	2	3	4	5	6	7	8	9	10	11	12
<b>7746</b>	2717	2881	3013	3212	3492	3625	3879	4284	4597	4944	5660	6424

OVERALL DIMENSIONS			SEAT DIMENSIONS			BACK DIMENSIONS	
W	D	H	W	D	H	W	H

45	29.5	32	24	19	18	27	14
----	------	----	----	----	----	----	----

RTA 00

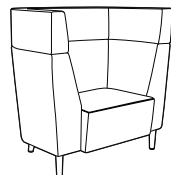

**Personal Harbor - High Back**  
COM Yardage: 7.09  
Freight Class: 300  
Product Weight (lbs.): 86  
Cubic Feet Per Carton: 40.25

For Power/USB module please see electrical placement chart. Freestanding unit only.

	1	2	3	4	5	6	7	8	9	10	11	12
<b>7747</b>	3820	4053	4238	4517	4913	5099	5457	6029	6470	6959	7968	9043

OVERALL DIMENSIONS			SEAT DIMENSIONS			BACK DIMENSIONS	
W	D	H	W	D	H	W	H

45	29.5	41.5	24	19	18	27	24
----	------	------	----	----	----	----	----

RTA 00

# LOUNGE

# RIVER™ PERSONAL HARBOR

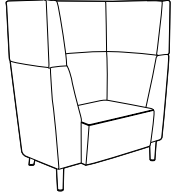
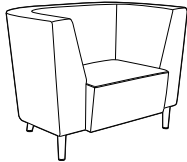
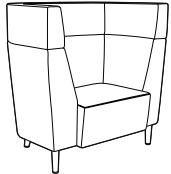
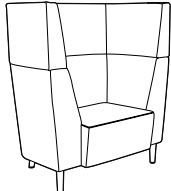
DESCRIPTION	FEATURES	MODEL#	STANDARD TEXTILE GRADES											
 <p><b>Personal Harbor - Extended Back</b> COM Yardage: 8.5 Freight Class: 300 Product Weight (lbs.): 102 Cubic Feet Per Carton: 45.75</p>	<p>For Power/USB module please see electrical placement chart. Freestanding unit only.</p>	<p><b>7748</b></p>	1	2	3	4	5	6	7	8	9	10	11	12
			4298	4552	4756	5063	5497	5701	6094	6720	7204	7740	8846	10025
			<b>OVERALL DIMENSIONS</b>			<b>SEAT DIMENSIONS</b>			<b>BACK DIMENSIONS</b>					
			W	D	H	W	D	H	W	H				
			45	29.5	47	24	19	18	27	29				
			<b>RTA 00</b>											
 <p><b>Personal Harbor - Standard Back</b> COM Yardage: 5.5 Freight Class: 150 Product Weight (lbs.): 70 Cubic Feet Per Carton: 31.75</p>	<p><b>High Traffic model</b> For Power/USB module please see electrical placement chart. Freestanding unit only.</p>	<p><b>7786</b></p>	1	2	3	4	5	6	7	8	9	10	11	12
			3102	3268	3399	3598	3878	4011	4266	4672	4984	5332	6048	6811
			<b>OVERALL DIMENSIONS</b>			<b>SEAT DIMENSIONS</b>			<b>BACK DIMENSIONS</b>					
			W	D	H	W	D	H	W	H				
			45	29.5	32	24	19	18	27	14				
			<b>RTA 00</b>											
 <p><b>Personal Harbor - High Back</b> COM Yardage: 7.09 Freight Class: 300 Product Weight (lbs.): 86 Cubic Feet Per Carton: 40.25</p>	<p><b>High Traffic model</b> For Power/USB module please see electrical placement chart. Freestanding unit only.</p>	<p><b>7787</b></p>	1	2	3	4	5	6	7	8	9	10	11	12
			4318	4551	4736	5016	5411	5598	5956	6528	6968	7458	8466	9540
			<b>OVERALL DIMENSIONS</b>			<b>SEAT DIMENSIONS</b>			<b>BACK DIMENSIONS</b>					
			W	D	H	W	D	H	W	H				
			45	29.5	41.5	24	19	18	27	24				
			<b>RTA 00</b>											
 <p><b>Personal Harbor - Extended Back</b> COM Yardage: 8.5 Freight Class: 300 Product Weight (lbs.): 102 Cubic Feet Per Carton: 45.75</p>	<p><b>High Traffic model</b> For Power/USB module please see electrical placement chart. Freestanding unit only.</p>	<p><b>7788</b></p>	1	2	3	4	5	6	7	8	9	10	11	12
			4683	4939	5143	5449	5883	6087	6480	7107	7591	8127	9233	10413
			<b>OVERALL DIMENSIONS</b>			<b>SEAT DIMENSIONS</b>			<b>BACK DIMENSIONS</b>					
			W	D	H	W	D	H	W	H				
			45	29.5	47	24	19	18	27	29				
			<b>RTA 00</b>											

# RIVER+ SEATING

## RIVER+ SEATING



Lounge Chair, High Back model R27802



120 Corner, Standard Back model R27824S



Loop arm R2770

### River+ Benches, Tables & Media Hearths



For River+ benches, please see page 331  
 For River+ media hearths, please see page 340  
 For River+ tables, please see page 336

### EXAMPLE RIVER+ SEATING ORDER CODE:

R27802	-CE90	-FOG	-	-S6	-
Model number	Back and seat textile	Connector finish	Shelf finish	Leg Selection	Counterweight
-CH	-SSB				
Leg finish	Bottom selection				

Additional Options specify at end of order code.	SPECIFY CODE
<b>Additional weight</b> See each model for amount of added weight and upcharge.	<b>CW</b>
<b>Sealed back seams</b> Upcharges vary, see model.	<b>SBS</b>
<b>Sealed seat seams</b> Upcharges vary, see model.	<b>SSS</b>
<b>Power unit finish</b> Jet Black White	<b>J</b> <b>W</b>
<b>Power/USB unit position</b> (see electrical placement images, not available on corner units) Front left Front right Side left Side right Center back (models with shelf only)	\$485 per unit <b>F1</b> <b>F2</b> <b>S1</b> <b>S2</b> <b>CB</b>
<b>Tamperproof fasteners</b> Upcharges vary, see model.	<b>TP</b>
<b>Moisture barrier</b> Upcharges vary, see model.	<b>MB</b>
<b>Accessory hook finish</b> (for models with shelf) Night (BLK) Fog (FOG) Latte (LAB)	<b>NHK</b> <b>FHK</b> <b>LHK</b>

\*linking hardware is lowered to clear the staple strip. Units will only gang with other units with sealed bottom.  
 \*\*cannot be combined with linking hardware or power units

### STANDARD FEATURES

- A modular series that is composed of straight, curved and corner sections.
- Units can be linked together in any combination to create a wide variety of layouts. Ganging hardware is standard and is factory installed. Ganging hardware swivels out of the way when not in use.
- Seating frames are constructed of heavy duty plywood, and are made for active environments. Seats are high density with highly resilient foam.
- River+ seating is rated for an active weight up to 600 lbs. per seat and 24/7 use.
- For 24/7 use and/or heavy duty application use, Global's Heavy Duty warranty is only on models specified with performance textiles, rated for 150,000 double rubs or more.
- A clean-out gap is created by seat-to-back connector brackets available in three finishes.
- The standard, 6.5" tapered legs are made of welded steel. Front legs of River+ lounge models are straight. Back legs are angled.
- Legs are standard in Chrome (CH) with Black, non-marking, height adjustable glides.
- Upholstery options include fabric or vinyl. Leather upholstery is not available.
- All units are shipped fully assembled.
- Polished Aluminum Loop arms are available with or without Nylon armcaps in Night (BK), Fog (FO), or Latte (LB). Arms are sold separately and field installed on seat to back connector.
- A 10" deep, 1" thick back shelf is available on corner, curved, two and three seater units in many thermally fused laminate finishes with matching edge.
- Shelf supports are aluminum with accessory hook in three finishes. Weight capacity: Shelf - 50lbs per seat; Hook - 20lbs each.
- Models with back shelf are only available with 6.5" high legs. Floor mount legs (F6) are standard. Non-floor mount legs (C6) are optional and include counterweight. Upcharges vary.
- Counterweights are required on models with back shelf unless mounted to the floor.
- Back shelf heights align with the model's back height. See shelf heights diagrams for details.

### OPTIONAL FEATURES

- Optional 6.5" floor mount legs (F6) are available for all models.
- Optional 8" (S8) and 8" floor mount legs (F8) are available on models without back shelves. Seat heights change to 19" high. Upcharges vary.
- Only models with similar leg heights can be ganged.
- Up to two power units are available on seating models, except 90 and 120 corner units. Add \$485 upcharge per unit.
- Each power unit includes one AC outlet and two USB-A, 10 watt charging ports. Location options include front or side. Back power location option available on models with back shelf (except corners). See electrical placement diagrams.
- Power units are available in either Jet Black (J) or White (W) with 120", three-prong matching cords.
- Sealed seams are available only for approved coated textiles. Specify (SSS) for sealed seat seams or (SBS) for sealed back seams. Contact customer care for details. See models for upcharge.
- To reduce ease of movement, counterweights can be added to any model. Specify (CW). See individual model for weight and upcharge.
- For improved housekeeping and infection control practices, the underside of the seat can be finished with black vinyl and sealed to prevent penetration of liquids. Specify (SP) - see each model for upcharge.
- Steel bottom option provides tamperproof protection (includes tamperproof screws). Specify (BS). Upcharges vary. Note: electrical option and ganging are not available with steel bottom.
- Tamperproof fasteners can be requested for a higher level of safety. Specify (TP) - see each model for upcharge.
- For moisture barrier on seat, specify (MB) - see each model for upcharge.

# LOUNGE

Add option codes in the following order:

- **Model number**  
**R27801 to R27803** Lounge chairs  
**R27804 to R27806** Two seaters  
**R27807 to R27809** Three seaters  
**R27810 to R27812** Bariatric lounge chairs  
**R27815 to R27817** Inside curve two seaters  
**R27818 to R27820** Outside curve two seaters  
**R27821 to R27823** 90 degree corners  
**R27824 to R27826** 120 degree corners  
 - Add (S) to model # if ordering with a back shelf (excludes lounge chairs and bariatric models).
- **Back and seat textile**  
Specify textile code.
- **Seat to back connector finish**  
**(NGT)** Night (BLK). No upcharge.  
**(FOG)** Fog. No upcharge.  
**(LAB)** Latte. No upcharge.
- **Back shelf finish** (for models ending in S)  
**(ACJ)** Absolute Acajou    **(ASN)** Asian Night  
**(AWC)** Avant Cherry    **(AWH)** Avant Honey  
**(BLK)** Black    **(BRC)** Brushed Cobalt  
**(CMB)** Clear Maple    **(DES)** Dark Espresso  
**(DWT)** Designer White    **(HGT)** Hayden Grey  
**(QTM)** Quartered Mahogany
- **(SOG)** Storm Grey  
**(TFW)** Tiger Fruitwood    **(TWL)** Tiger Walnut  
**(WCR)** Winter Cherry    **(WGY)** Willow Grey  
**(WHC)** White Chocolate    **(WHE)** Walnut Heights (colors shown on website)
- **Accessory hook finish** (for models with shelf)  
**(NHK)** Night (BLK)  
**(FHK)** Fog (FOG)  
**(LHK)** Latte (LAB)
- **Leg selection** (models without shelf):  
**(S6)** Standard seat height (17.5"), 6.5" leg w/adjustable glides. No upcharge.  
**(S8)** High seat (19"), 8" leg w/adjustable glides. No upcharge.  
**(F6)** Standard seat height (17.5"), 6.5" leg w/floor mount. Add \$72 for straight units; \$90 for curved, corner units.  
**(F8)** High seat (19"), 8" leg w/floor mount. Add \$72 for straight units; \$90 for curved, corner units.
- **Additional weight**  
**(CW)** Counterweight. See each model for amount of added weight and upcharge.
- **Leg selection** (models with shelf):  
**(F6)** Standard seat height (17.5"), 6.5" leg w/floor mount. No upcharge.  
**(C6)** Standard seat height (17.5"), 6.5" leg, no floor mount, with counterweight included. Upcharges vary, see model listings for (C6) values.
- **Leg finish**  
**(CH)** Chrome. No upcharge.  
**(BK)** Black. No upcharge.  
**(LT)** Latte. No upcharge.  
**(TU)** Tungsten. No upcharge.
- **Bottom selection**  
**(SSB)** Standard seat bottom  
**(SP)** Vinyl sealed bottom with staple strip. Upcharges vary, see model.\*  
**(BS)** Steel bottom. Upcharges vary, see model.\*\*
- **Sealed back seams**  
**(SBS)** Sealed back seams. Upcharges vary, see model.
- **Sealed seat seams**  
**(SSS)** Sealed seat seams. Upcharges vary, see model.
- **Moisture barrier**  
**(MB)** Moisture Barrier. Upcharges vary, see model.
- **Power/USB unit position. Add \$485 per unit.**  
**(NP)** No power (no upcharge)  
**(F1)** Front left  
**(F2)** Front right  
**(S1)** Side left  
**(S2)** Side right  
**(CB)** Center back (models with shelf only)
- **Power unit finish**  
**(J)** Jet Black  
**(W)** White
- **Tamperproof fasteners.**  
**(TP)** Tamperproof fasteners. Upcharges vary, see model.

SHELF HEIGHTS

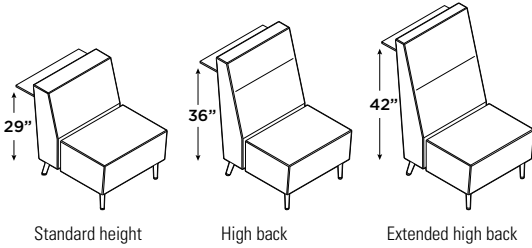



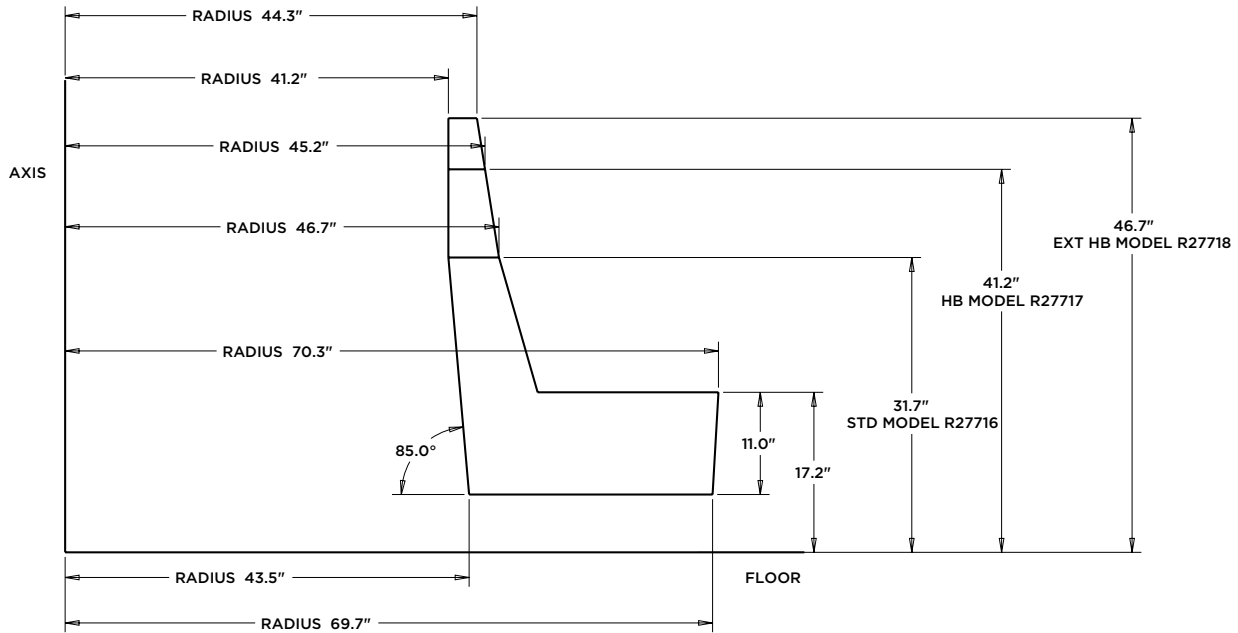

DIMENSIONS

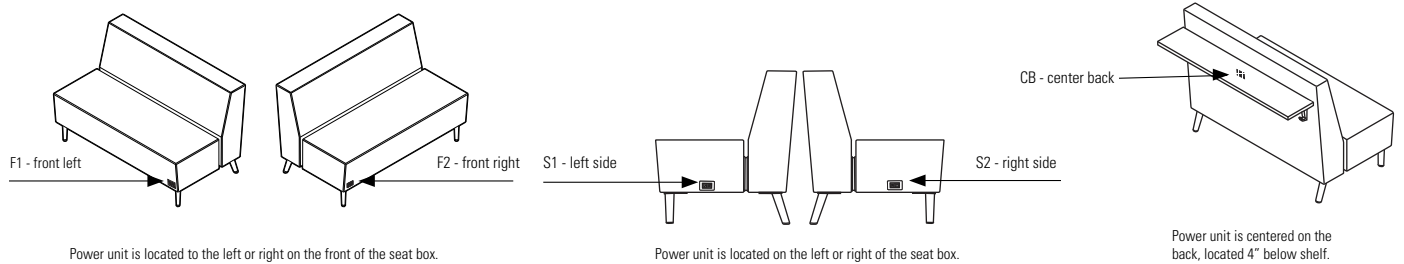

ELECTRICAL PLACEMENT

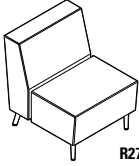
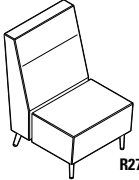
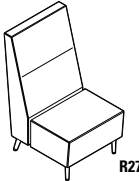

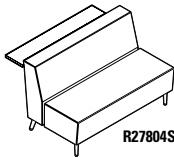

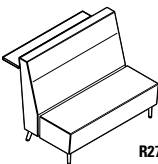
DESCRIPTION	FEATURES	MODEL#	STANDARD TEXTILE GRADES														
			1	2	3	4	5	6	7	8	9	10	11	12			
 <p><b>R27801</b></p> <p><b>Lounge Chair - Standard Back</b> COM Yardage: 3.75 Freight class: 250 Product weight (lbs.): 61 Cubic feet per carton: 19.75</p>	<p>For power/USB unit, see electrical placement chart.</p> <p>Includes ganging hardware (2 sides).</p> <p>Add \$46 for (SSS), \$50 (SBS) Add \$463 for 36 lbs. (CW), (C6) Add \$74 for (SP) or \$357 for (BS) Add \$28 for (TP) Add \$92 for (MB)</p>	<b>R27801</b>	1450	1549	1628	1746	1914	1992	2144	2386	2573	2781	3208	3664			
		<b>OVERALL DIMENSIONS</b>			<b>SEAT DIMENSIONS</b>			<b>BACK DIMENSIONS</b>									
		<b>W</b>	<b>D</b>	<b>H</b>	<b>W</b>	<b>D</b>	<b>H</b>	<b>W</b>	<b>H</b>								
		26	30	32	26	19	18	26	14								
			<b>RTA 00</b>		1 per carton												
 <p><b>R27802</b></p> <p><b>Lounge Chair - High Back</b> COM Yardage: 4.50 Freight class: 250 Product weight: 71 Cubic feet per carton: 24.75</p>	<p>For power/USB unit, see electrical placement chart.</p> <p>Includes ganging hardware (2 sides).</p> <p>Add \$46 for (SSS), \$71 for (SBS) Add \$463 for 36 lbs. (CW), (C6) Add \$74 for (SP) or \$357 for (BS) Add \$28 for (TP) Add \$92 for (MB)</p>	<b>R27802</b>	1700	1823	1920	2065	2272	2369	2556	2854	3084	3339	3865	4426			
		<b>OVERALL DIMENSIONS</b>			<b>SEAT DIMENSIONS</b>			<b>BACK DIMENSIONS</b>									
		<b>W</b>	<b>D</b>	<b>H</b>	<b>W</b>	<b>D</b>	<b>H</b>	<b>W</b>	<b>H</b>								
		26	30.5	41.5	26	19	18	26	23.5								
			<b>RTA 00</b>		1 per carton												
 <p><b>R27803</b></p> <p><b>Lounge Chair - Extended Back</b> COM Yardage: 4.75 Freight class: 250 Product weight: 81 Cubic feet per carton: 28</p>	<p>For power/USB unit, see electrical placement chart.</p> <p>Includes ganging hardware (2 sides).</p> <p>Add \$46 for (SSS), \$76 for (SBS) Add \$463 for 36 lbs. (CW), (C6) Add \$74 for (SP) or \$357 for (BS) Add \$28 for (TP) Add \$92 for (MB)</p>	<b>R27803</b>	2021	2165	2280	2453	2698	2814	3036	3390	3663	3966	4590	5256			
		<b>OVERALL DIMENSIONS</b>			<b>SEAT DIMENSIONS</b>			<b>BACK DIMENSIONS</b>									
		<b>W</b>	<b>D</b>	<b>H</b>	<b>W</b>	<b>D</b>	<b>H</b>	<b>W</b>	<b>H</b>								
		26	31	47	26	19	18	26	29								
			<b>RTA 00</b>		1 per carton												
 <p><b>R27804</b></p>	 <p><b>R27804S</b></p>	<p>For power/USB unit, see electrical placement chart.</p> <p>Includes ganging hardware (2 sides).</p> <p>Add \$69 for (SSS), \$86 for (SBS) Add \$926 for 72 lbs. (CW), (C6) Add \$142 for (SP) or \$567 for (BS) Add \$28 for (TP) Add \$183 for (MB)</p>	<b>R27804</b>	2260	2388	2489	2642	2857	2959	3154	3466	3706	3973	4523	5109		
			<b>R27804S</b>	2770	2903	3008	3166	3390	3496	3699	4024	4273	4551	5123	5733		
			<b>OVERALL DIMENSIONS</b>			<b>SEAT DIMENSIONS</b>			<b>BACK DIMENSIONS</b>								
			<b>W</b>	<b>D</b>	<b>H</b>	<b>W</b>	<b>D</b>	<b>H</b>	<b>W</b>	<b>H</b>							
52	30	32	52	19	18	52	14										
			<b>RTA 00</b>		1 per carton												
 <p><b>R27805</b></p>	 <p><b>R27805S</b></p>	<p>For power/USB unit, see electrical placement chart.</p> <p>Includes ganging hardware (2 sides).</p> <p>Add \$69 for (SSS), \$114 for (SBS) Add \$926 for 72 lbs. (CW), (C6) Add \$142 for (SP) or \$567 for (BS) Add \$28 for (TP) Add \$183 for (MB)</p>	<b>R27805</b>	2750	2912	3040	3232	3504	3633	3880	4274	4577	4914	5609	6350		
			<b>R27805S</b>	3260	3414	3538	3723	3985	4108	4346	4725	5017	5342	6010	6723		
			<b>OVERALL DIMENSIONS</b>			<b>SEAT DIMENSIONS</b>			<b>BACK DIMENSIONS</b>								
			<b>W</b>	<b>D</b>	<b>H</b>	<b>W</b>	<b>D</b>	<b>H</b>	<b>W</b>	<b>H</b>							
52	30.5	41.5	52	19	18	52	23.5										
			<b>RTA 00</b>		1 per carton												

Options: (SBS) Sealed back seams (SSS) Sealed seat seams (CW), (C6) Counterweight (SP) Vinyl sealed bottom (BS) Steel bottom (TP) Tamperproof (MB) Moisture barrier

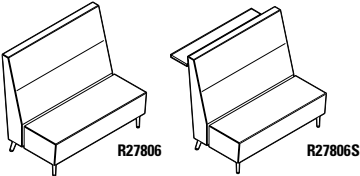
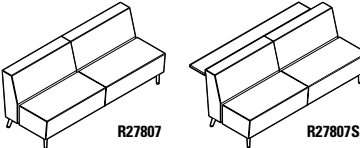
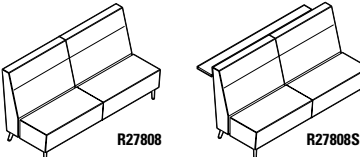
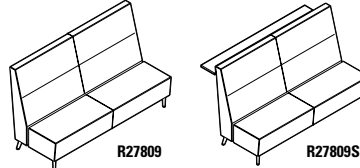
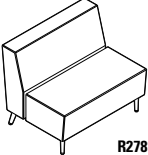
DESCRIPTION	FEATURES	MODEL#	STANDARD TEXTILE GRADES												
			1	2	3	4	5	6	7	8	9	10	11	12	
 <p><b>Two Seater - Extended Back</b> COM Yardage: 5.5 Freight class: 250 Product weight: 71 Cubic feet per carton: 24.75</p>	<p>For power/USB unit, see electrical placement chart.</p> <p>Includes ganging hardware (2 sides).</p> <p>Add \$69 for <b>(SSS)</b>, \$122 for <b>(SBS)</b> Add \$926 for 72 lbs. <b>(CW), (C6)</b> Add \$142 for <b>(SP)</b> or \$567 for <b>(BS)</b> Add \$28 for <b>(TP)</b> Add \$183 for <b>(MB)</b></p>	<b>R27806</b>	3131	3319	3469	3695	4014	4165	4455	4916	5273	5668	6483	7352	
		<b>R27806S</b>	3641	3820	3963	4177	4480	4623	4898	5335	5674	6049	6822	7646	
		<b>OVERALL DIMENSIONS</b>			<b>SEAT DIMENSIONS</b>			<b>BACK DIMENSIONS</b>							
		<b>W</b>	<b>D</b>	<b>H</b>	<b>W</b>	<b>D</b>	<b>H</b>	<b>W</b>	<b>H</b>						
								52	31	47	52	19	18	52	29
								<b>RTA 00</b>	1 per carton						
 <p><b>Three Seater - Standard Back</b> COM Yardage: 8 Freight class: 250 Product weight: 152 Cubic feet per carton: 55.50</p>	<p>For power/USB unit, see electrical placement chart.</p> <p>Includes ganging hardware (2 sides).</p> <p>Add \$84 for <b>(SSS)</b>, \$100 for <b>(SBS)</b> Add \$926 for 72 lbs. <b>(CW), (C6)</b> Add \$215 for <b>(SP)</b> or \$781 for <b>(BS)</b> Add \$28 for <b>(TP)</b> Add \$275 for <b>(MB)</b></p>	<b>R27807</b>	3544	3770	3951	4222	4606	4787	5135	5690	6119	6594	7574	8618	
		<b>R27807S</b>	4219	4443	4622	4891	5272	5452	5797	6348	6773	7244	8216	9252	
		<b>OVERALL DIMENSIONS</b>			<b>SEAT DIMENSIONS</b>			<b>BACK DIMENSIONS</b>							
		<b>W</b>	<b>D</b>	<b>H</b>	<b>W</b>	<b>D</b>	<b>H</b>	<b>W</b>	<b>H</b>						
								78	30	32	78	19	18	78	14
								<b>RTA 00</b>	1 per carton						
 <p><b>Three Seater - High Back</b> COM Yardage: 9.25 Freight class: 250 Product weight: 177 Cubic feet per carton: 69.75</p>	<p>For power/USB unit, see electrical placement chart.</p> <p>Includes ganging hardware (2 sides).</p> <p>Add \$84 for <b>(SSS)</b>, \$134 for <b>(SBS)</b> Add \$926 for 72 lbs. <b>(CW), (C6)</b> Add \$215 for <b>(SP)</b> or \$781 for <b>(BS)</b> Add \$28 for <b>(TP)</b> Add \$275 for <b>(MB)</b></p>	<b>R27808</b>	4134	4407	4625	4953	5417	5636	6057	6727	7245	7819	9003	10266	
		<b>R27808S</b>	4809	5080	5295	5618	6076	6292	6707	7369	7879	8446	9613	10859	
		<b>OVERALL DIMENSIONS</b>			<b>SEAT DIMENSIONS</b>			<b>BACK DIMENSIONS</b>							
		<b>W</b>	<b>D</b>	<b>H</b>	<b>W</b>	<b>D</b>	<b>H</b>	<b>W</b>	<b>H</b>						
								78	30.5	41.5	78	19	18	78	23.5
								<b>RTA 00</b>	1 per carton						
 <p><b>Three Seater - Extended Back</b> COM Yardage: 10 Freight class: 250 Product weight: 165 Cubic feet per carton: 79.25</p>	<p>For power/USB unit, see electrical placement chart.</p> <p>Includes ganging hardware (2 sides).</p> <p>Add \$84 for <b>(SSS)</b>, \$142 for <b>(SBS)</b> Add \$926 for 72 lbs. <b>(CW), (C6)</b> Add \$215 for <b>(SP)</b> or \$781 for <b>(BS)</b> Add \$28 for <b>(TP)</b> Add \$275 for <b>(MB)</b></p>	<b>R27809</b>	4484	4790	5035	5402	5924	6169	6641	7394	7975	8619	9947	11364	
		<b>R27809S</b>	5159	5461	5701	6062	6574	6815	7279	8017	8588	9221	10525	11916	
		<b>OVERALL DIMENSIONS</b>			<b>SEAT DIMENSIONS</b>			<b>BACK DIMENSIONS</b>							
		<b>W</b>	<b>D</b>	<b>H</b>	<b>W</b>	<b>D</b>	<b>H</b>	<b>W</b>	<b>H</b>						
								78	31	47	78	19	18	78	29
								<b>RTA 00</b>	1 per carton						
 <p><b>Bariatric Lounge Chair - Standard Back</b> COM Yardage: 4.25 Freight class: 250 Product weight: 90 Cubic feet per carton: 28.75</p>	<p>For power/USB unit, see electrical placement chart.</p> <p>Includes ganging hardware (2 sides).</p> <p>Add \$50 for <b>(SSS)</b>, \$61 for <b>(SBS)</b> Add \$463 for 36 lbs. <b>(CW), (C6)</b> Add \$100 for <b>(SP)</b> or \$498 for <b>(BS)</b> Add \$28 for <b>(TP)</b> Add \$138 for <b>(MB)</b></p>	<b>R27810</b>	2213	2343	2445	2600	2818	2921	3119	3435	3679	3949	4506	5101	
		<b>OVERALL DIMENSIONS</b>			<b>SEAT DIMENSIONS</b>			<b>BACK DIMENSIONS</b>							
		<b>W</b>	<b>D</b>	<b>H</b>	<b>W</b>	<b>D</b>	<b>H</b>	<b>W</b>	<b>H</b>						
										39	30	32	39	19	18
								<b>RTA 00</b>	1 per carton						

Options: **(SBS)** Sealed back seams  
**(SSS)** Sealed seat seams  
**(CW), (C6)** Counterweight  
**(SP)** Vinyl sealed bottom  
**(BS)** Steel bottom  
**(TP)** Tamperproof  
**(MB)** Moisture barrier

# RIVER+ SEATING

# LOUNGE

DESCRIPTION	FEATURES	MODEL#	STANDARD TEXTILE GRADES											
			1	2	3	4	5	6	7	8	9	10	11	12

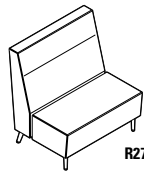

R27811

**Bariatric Lounge Chair - High Back**

COM Yardage: 4.75  
 Freight class: 250  
 Product weight: 98  
 Cubic feet per carton: 36

For power/USB unit, see electrical placement chart.  
 Includes ganging hardware (2 sides).

Add \$50 for (SSS), \$80 for (SBS)  
 Add \$463 for 36 lbs. (CW), (C6)  
 Add \$100 for (SP) or \$498 for (BS)  
 Add \$28 for (TP)  
 Add \$138 for (MB)

R27811	2461	2605	2720	2892	3136	3251	3473	3826	4098	4400	5023	5687
--------	------	------	------	------	------	------	------	------	------	------	------	------

OVERALL DIMENSIONS	SEAT DIMENSIONS			BACK DIMENSIONS	
	W	D	H	W	H

39	30.5	41.5	39	19	18	39	23.5
----	------	------	----	----	----	----	------

RTA 00	1 per carton											
--------	--------------	--	--	--	--	--	--	--	--	--	--	--

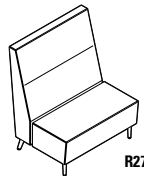

R27812

**Bariatric Lounge Chair - Extended Back**

COM Yardage: 5.25  
 Freight class: 250  
 Product weight: 115  
 Cubic feet per carton: 41

For power/USB unit, see electrical placement chart.  
 Includes ganging hardware (2 sides).

Add \$50 for (SSS), \$86 for (SBS)  
 Add \$463 for 36 lbs. (CW), (C6)  
 Add \$100 for (SP) or \$498 for (BS)  
 Add \$28 for (TP)  
 Add \$138 for (MB)

R27812	2606	2766	2893	3084	3354	3481	3725	4116	4417	4751	5439	6173
--------	------	------	------	------	------	------	------	------	------	------	------	------

OVERALL DIMENSIONS	SEAT DIMENSIONS			BACK DIMENSIONS	
	W	D	H	W	H

39	31	47	39	19	18	39	29
----	----	----	----	----	----	----	----

RTA 00	1 per carton											
--------	--------------	--	--	--	--	--	--	--	--	--	--	--

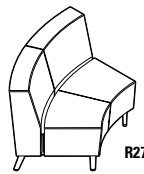

R27815

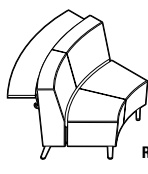

R27815S

**Inside Curve Two Seater - Standard Back**

COM Yardage: 5  
 Freight class: 250  
 Product weight: 93  
 Cubic feet per carton: 42.75

For power/USB unit, see electrical placement chart.  
 Includes ganging hardware (2 sides).

Add \$61 for (SSS), \$86 for (SBS)  
 Add \$926 for 72 lbs. (CW), (C6)  
 Add \$126 for (SP) or \$567 for (BS)  
 Add \$28 for (TP)  
 Add \$183 for (MB)

R27815	2385	2524	2635	2802	3038	3149	3363	3704	3967	4259	4861	5503
R27815S	3080	3219	3330	3497	3733	3844	4058	4399	4662	4954	5556	6198

OVERALL DIMENSIONS	SEAT DIMENSIONS			BACK DIMENSIONS	
	W	D	H	W	H

50.5	30	32	42	19	18	51	14
------	----	----	----	----	----	----	----

RTA 00	1 per carton											
--------	--------------	--	--	--	--	--	--	--	--	--	--	--

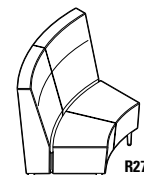

R27816

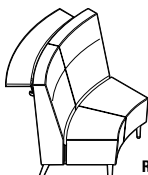

R27816S

**Inside Curve Two Seater - High Back**

COM Yardage: 5.50  
 Freight class: 300  
 Product weight: 106  
 Cubic feet per carton: 53.75

For power/USB unit, see electrical placement chart.  
 Includes ganging hardware (2 sides).

Add \$61 for (SSS), \$114 for (SBS)  
 Add \$926 for 72 lbs. (CW), (C6)  
 Add \$126 for (SP) or \$567 for (BS)  
 Add \$28 for (TP)  
 Add \$183 for (MB)

R27816	3105	3277	3414	3621	3913	4051	4316	4738	5064	5426	6172	6967
R27816S	3800	3964	4094	4290	4567	4698	4949	5349	5659	6001	6708	7462

OVERALL DIMENSIONS	SEAT DIMENSIONS			BACK DIMENSIONS	
	W	D	H	W	H

51	30.5	41.5	42	19	18	51	23.5
----	------	------	----	----	----	----	------

RTA 00	1 per carton											
--------	--------------	--	--	--	--	--	--	--	--	--	--	--

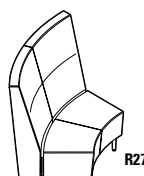

R27817

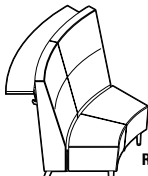

R27817S

**Inside Curve Two Seater - Extended Back**

COM Yardage: 6  
 Freight class: 300  
 Product weight: 118  
 Cubic feet per carton: 61

For power/USB unit, see electrical placement chart.  
 Includes ganging hardware (2 sides).

Add \$61 for (SSS), \$122 for (SBS)  
 Add \$926 for 72 lbs. (CW), (C6)  
 Add \$126 for (SP) or \$567 for (BS)  
 Add \$28 for (TP)  
 Add \$183 for (MB)

R27817	3289	3478	3628	3853	4172	4322	4612	5073	5428	5823	6637	7504
R27817S	3984	4163	4306	4519	4822	4965	5239	5677	6015	6389	7161	7985

OVERALL DIMENSIONS	SEAT DIMENSIONS			BACK DIMENSIONS	
	W	D	H	W	H

51.5	31	47	42	19	18	51	29
------	----	----	----	----	----	----	----

RTA 00	1 per carton											
--------	--------------	--	--	--	--	--	--	--	--	--	--	--





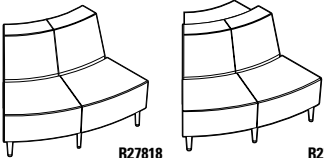
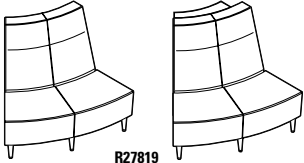
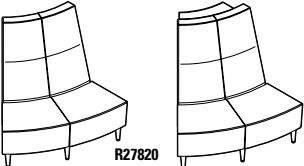
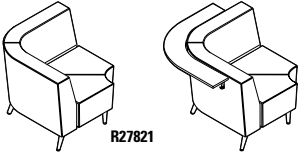
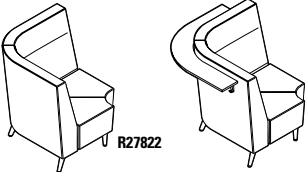

Options: (SBS) Sealed back seams (SP) Vinyl sealed bottom  
 (SSS) Sealed seat seams (BS) Steel bottom  
 (CW), (C6) Counterweight (TP) Tamperproof  
 (MB) Moisture barrier

# LOUNGE

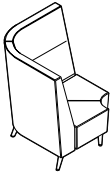
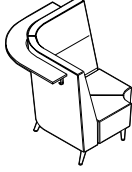
# RIVER+ SEATING

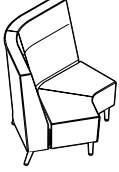
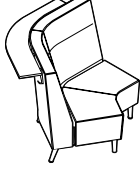
DESCRIPTION	FEATURES	MODEL#	STANDARD TEXTILE GRADES											
			1	2	3	4	5	6	7	8	9	10	11	12
 <p><b>R27818</b>      <b>R27818S</b></p> <p><b>Outside Curve Two Seater - Standard Back</b> COM: 4.25 Freight class: 4.25 Product weight: 93 Cubic feet per carton: 42.75</p>	<p>For power/USB unit, see electrical placement chart.</p> <p>Includes ganging hardware (2 sides).</p> <p>Add \$67 for <b>(SSS)</b>, \$75 for <b>(SBS)</b> Add \$926 for 72 lbs. <b>(CW)</b>, <b>(C6)</b> Add \$126 for <b>(SP)</b> or \$640 for <b>(BS)</b> Add \$28 for <b>(TP)</b> Add \$183 for <b>(MB)</b></p>	<p><b>R27818</b>    2326   2444   2539   2680   2881   2975   3157   3447   3671   3919   4431   4976</p> <p><b>R27818S</b>   3021   3147   3247   3395   3606   3706   3897   4201   4437   4697   5235   5809</p>												
			<p><b>OVERALL DIMENSIONS</b> W      D      H</p> <p>50      30      32</p> <p><b>SEAT DIMENSIONS</b> W      D      H</p> <p>50      19      18</p> <p><b>BACK DIMENSIONS</b> W      H</p> <p>36      14</p>	<p><b>RTA 00</b>      1 per carton</p>										
 <p><b>R27819</b>      <b>R27819S</b></p> <p><b>Outside Curve Two Seater - High Back</b> COM Yardage: 5.25 Freight class: 300 Product weight: 101 Cubic feet per carton: 53.75</p>	<p>For power/USB unit, see electrical placement chart.</p> <p>Includes ganging hardware (2 sides).</p> <p>Add \$67 for <b>(SSS)</b>, \$98 for <b>(SBS)</b> Add \$926 for 72 lbs. <b>(CW)</b>, <b>(C6)</b> Add \$126 for <b>(SP)</b> or \$640 for <b>(BS)</b> Add \$28 for <b>(TP)</b> Add \$183 for <b>(MB)</b></p>	<p><b>R27819</b>    2770   2923   3044   3227   3487   3609   3844   4218   4507   4828   5489   6194</p> <p><b>R27819S</b>   3465   3627   3755   3948   4221   4349   4597   4992   5296   5634   6330   7073</p>												
			<p><b>OVERALL DIMENSIONS</b> W      D      H</p> <p>50      30.5   41.5</p> <p><b>SEAT DIMENSIONS</b> W      D      H</p> <p>50      19      18</p> <p><b>BACK DIMENSIONS</b> W      H</p> <p>32      23.5</p>	<p><b>RTA 00</b>      1 per carton</p>										
 <p><b>R27820</b>      <b>R27820S</b></p> <p><b>Outside Curve Two Seater - Extended Back</b> COM Yardage: 6.25 Freight class: 300 Product weight: 109 Cubic feet per carton: 61</p>	<p>For power/USB unit, see electrical placement chart.</p> <p>Includes ganging hardware (2 sides).</p> <p>Add \$67 for <b>(SSS)</b>, \$104 for <b>(SBS)</b> Add \$926 for 72 lbs. <b>(CW)</b>, <b>(C6)</b> Add \$126 for <b>(SP)</b> or \$640 for <b>(BS)</b> Add \$28 for <b>(TP)</b> Add \$183 for <b>(MB)</b></p>	<p><b>R27820</b>    3051   3242   3393   3621   3944   4096   4388   4854   5214   5613   6436   7313</p> <p><b>R27820S</b>   3746   3946   4106   4346   4686   4847   5155   5647   6026   6447   7315   8240</p>												
			<p><b>OVERALL DIMENSIONS</b> W      D      H</p> <p>50      31      47</p> <p><b>SEAT DIMENSIONS</b> W      D      H</p> <p>50      19      18</p> <p><b>BACK DIMENSIONS</b> W      H</p> <p>28      29</p>	<p><b>RTA 00</b>      1 per carton</p>										
 <p><b>R27821</b>      <b>R27821S</b></p> <p><b>90 Corner - Standard Back</b> COM Yardage: 6 Freight class: 250 Product weight: 105 Cubic feet per carton: 35.50</p>	<p>No power/USB unit.</p> <p>Includes ganging hardware (2 sides).</p> <p>Add \$48 for <b>(SSS)</b>, \$94 for <b>(SBS)</b> Add \$926 for 72 lbs. <b>(CW)</b>, <b>(C6)</b> Add \$126 for <b>(SP)</b> or \$640 for <b>(BS)</b> Add \$28 for <b>(TP)</b> Add \$183 for <b>(MB)</b></p>	<p><b>R27821</b>    3077   3252   3392   3603   3901   4041   4311   4741   5074   5442   6202   7012</p> <p><b>R27821S</b>   4052   4225   4362   4567   4859   4996   5261   5682   6007   6368   7111   7904</p>												
			<p><b>OVERALL DIMENSIONS</b> W      D      H</p> <p>37.5   37.5   32</p> <p><b>SEAT DIMENSIONS</b> W      D      H</p> <p>24      19      18</p> <p><b>BACK DIMENSIONS</b> W      H</p> <p>24      14</p>	<p><b>RTA 00</b>      1 per carton</p>										
 <p><b>R27822</b>      <b>R27822S</b></p> <p><b>90 Corner - High Back</b> COM Yardage: 7.75 Freight class: 250 Product weight: 119 Cubic feet per carton: 44.50</p>	<p>No power/USB unit.</p> <p>Includes ganging hardware (2 sides).</p> <p>Add \$48 for <b>(SSS)</b>, \$125 for <b>(SBS)</b> Add \$926 for 72 lbs. <b>(CW)</b>, <b>(C6)</b> Add \$126 for <b>(SP)</b> or \$450 for <b>(BS)</b> Add \$28 for <b>(TP)</b> Add \$183 for <b>(MB)</b></p>	<p><b>R27822</b>    3664   3904   4094   4381   4787   4978   5346   5933   6385   6887   7922   9026</p> <p><b>R27822S</b>   4639   4864   5043   5313   5695   5875   6221   6773   7200   7672   8647   9686</p>												
			<p><b>OVERALL DIMENSIONS</b> W      D      H</p> <p>38.5   38.5   41.5</p> <p><b>SEAT DIMENSIONS</b> W      D      H</p> <p>24      19      18</p> <p><b>BACK DIMENSIONS</b> W      H</p> <p>24      23.5</p>	<p><b>RTA 00</b>      1 per carton</p>										

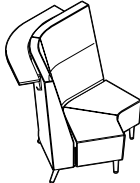
Options: **(SBS)** Sealed back seams      **(SP)** Vinyl sealed bottom  
**(SSS)** Sealed seat seams            **(BS)** Steel bottom  
**(CW)**, **(C6)** Counterweight           **(TP)** Tamperproof  
**(MB)** Moisture barrier

DESCRIPTION	FEATURES	MODEL#	STANDARD TEXTILE GRADES													
			1	2	3	4	5	6	7	8	9	10	11	12		
  <p><b>90 Corner - Extended Back</b> COM Yardage: 8.25 Freight class: 250 Product weight: 128 Cubic feet per carton: 50.50</p>	<p>No power/USB unit.</p> <p>Includes ganging hardware (2 sides).</p> <p>Add \$48 for (SSS), \$130 for (SBS) Add \$926 for 36 lbs. (CW), (C6) Add \$126 for (SP) or \$640 for (BS) Add \$28 for (TP) Add \$183 for (MB)</p>	<b>R27823</b>	4030	4284	4487	4792	5225	5428	5820	6445	6927	7461	8563	9739		
		<b>R27823S</b>	5005	5250	5444	5736	6151	6346	6721	7319	7781	8293	9348	10474		
		<b>OVERALL DIMENSIONS</b>			<b>SEAT DIMENSIONS</b>			<b>BACK DIMENSIONS</b>								
		W D H			W D H			W H								
		39 39 47			24 19 18			24 29								
			<b>RTA 00</b>			1 per carton										
  <p><b>120 Corner - Standard Back</b> COM Yardage: 6 Freight class: 250 Product weight: 109 Cubic feet per carton: 48.25</p>	<p>No power/USB unit.</p> <p>Includes ganging hardware (2 sides).</p> <p>Add \$64 for (SSS), \$91 for (SBS) Add \$926 for 36 lbs. (CW), (C6) Add \$158 for (SP) or \$708 for (BS) Add \$28 for (TP) Add \$183 for (MB)</p>	<b>R27824</b>	3186	3368	3513	3731	4040	4185	4465	4910	5254	5636	6422	7261		
		<b>R27824S</b>	4161	4338	4479	4690	4990	5131	5402	5835	6169	6539	7303	8117		
		<b>OVERALL DIMENSIONS</b>			<b>SEAT DIMENSIONS</b>			<b>BACK DIMENSIONS</b>								
		W D H			W D H			W H								
		52.5 30 32			52 19 18			52 14								
			<b>RTA 00</b>			1 per carton										
  <p><b>120 Corner - High Back</b> COM Yardage: 7.75 Freight class: 300 Product weight: 118 Cubic feet per carton: 60.50</p>	<p>No power/USB unit.</p> <p>Includes ganging hardware (2 sides).</p> <p>Add \$64 for (SSS), \$119 for (SBS) Add \$926 for 36 lbs. (CW), (C6) Add \$158 for (SP) or \$708 for (BS) Add \$28 for (TP) Add \$183 for (MB)</p>	<b>R27825</b>	3728	3966	4156	4442	4847	5037	5404	5989	6440	6941	7973	9073		
		<b>R27825S</b>	4703	4931	5113	5386	5774	5956	6307	6867	7299	7778	8766	9819		
		<b>OVERALL DIMENSIONS</b>			<b>SEAT DIMENSIONS</b>			<b>BACK DIMENSIONS</b>								
		W D H			W D H			W H								
		53.5 30.5 41.5			41 21 18			51 23.5								
			<b>RTA 00</b>			1 per carton										
  <p><b>120 Corner - Extended Back</b> COM Yardage: 8.25 Freight class: 300 Product weight: 123 Cubic feet per carton: 68.75</p>	<p>No power/USB unit.</p> <p>Includes ganging hardware (2 sides).</p> <p>Add \$64 for (SSS), \$127 for (SBS) Add \$926 for 36 lbs. (CW), (C6) Add \$158 for (SP) or \$708 for (BS) Add \$28 for (TP) Add \$183 for (MB)</p>	<b>R27826</b>	4044	4297	4500	4804	5235	5438	5828	6451	6931	7464	8563	9734		
		<b>R27826S</b>	5019	5273	5474	5777	6206	6408	6797	7417	7895	8426	9519	10686		
		<b>OVERALL DIMENSIONS</b>			<b>SEAT DIMENSIONS</b>			<b>BACK DIMENSIONS</b>								
		W D H			W D H			W H								
		54 31.5 47			41 21 18			51 29								
			<b>RTA 00</b>			1 per carton										
 <p><b>Loop Arm</b> COM Yardage: N/A Freight class: 92.5 Product weight (lbs.): 6.30 Cubic feet per carton: .60</p>	<p>Attachment hardware included. Polished Aluminum arms sold separately (1 pc).</p> <p>Armcap finish options: (NGT) Night, (FOG) Fog, (LAB) Latte</p>	List price														
		<b>R2770</b>	232													
		<b>OVERALL DIMENSIONS</b>			<b>SEAT DIMENSIONS</b>			<b>BACK DIMENSIONS</b>								
		W D H			W D H			W H								
		2.5 14. 19.5			- - -			- - -								
			<b>RTA 1</b>			1 per carton										
 <p><b>Loop Arm w/Armcap</b> COM Yardage: N/A Freight class: 92.5 Product weight (lbs.): 6.61 Cubic feet per carton: .60</p>	<p>Attachment hardware included. Polished Aluminum arms sold separately (1 pc).</p> <p>Armcap finish options: (NGT) Night, (FOG) Fog, (LAB) Latte</p>	List price														
		<b>R2771</b>	264													
		<b>OVERALL DIMENSIONS</b>			<b>SEAT DIMENSIONS</b>			<b>BACK DIMENSIONS</b>								
		W D H			W D H			W H								
		2.5 14 19.5			- - -			- - -								
			<b>RTA 1</b>			1 per carton										

Options: (SBS) Sealed back seams (SP) Vinyl sealed bottom (SSS) Sealed seat seams (BS) Steel bottom (CW), (C6) Counterweight (TP) Tamperproof (MB) Moisture barrier

# LOUNGE

## RIVER+ BENCHES

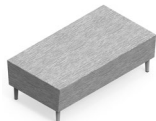

**Two Seater Bench**  
model R27832

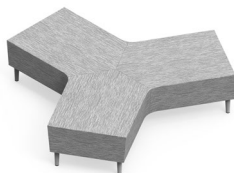

**Y Bench**  
model R27842



**42" Round Bench**  
model R27845

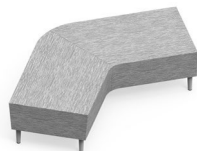

**Inside Curve Boomerang Bench**  
model R27840

### River+ Seating, Tables & Media Hearths

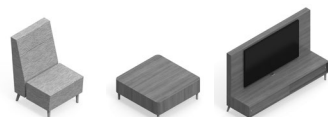

For River+ seating, please see page 324  
For River+ tables, please see page 336  
For River+ media hearths, please see page 340

### EXAMPLE RIVER+ BENCH ORDER CODE:

R27832	-CE90	-S6	-AS	-CH	-	-SP
--------	-------	-----	-----	-----	---	-----

Model number    Textile    Leg selection    Leg angle    Leg finish    Additional weight    Bottom selection

-	-	-F1	-W
---	---	-----	----

Sealed Seams    Moisture barrier    Power/USB position    Power finish

Additional Options specify at end of order code.	SPECIFY CODE
<b>Tamperproof fasteners</b> Upcharges vary, see model.	<b>TP</b>
<b>Moisture barrier</b> Upcharges vary, see model.	<b>MB</b>

\*linking hardware is lowered to clear the staple strip.  
Units will only gang with other units with sealed bottom.  
\*\*cannot be combined with linking hardware or power units

# RIVER+ BENCHES

### STANDARD FEATURES

- A modular series that is composed of straight, and curved sections, as well as freestanding units.
- Linking units can be used together in any combination to create a wide variety of layouts. Ganging hardware is standard and is factory installed. Ganging hardware swivels out of the way when not in use.
- The standard, 6.5" tapered legs are made of welded steel.
- Legs are straight (vertical) as standard. Linking models are optionally available with angled back legs to match River+ seating units.
- Legs are standard in Chrome with Black non-marking height adjustable glides.
- River+ is rated for an active weight up to 600 lbs. per seat and 24/7 use.
- For 24/7 use and/or heavy duty application use, Global's Heavy Duty warranty is applicable on models specified with performance textiles, rated for 150,000 double rubs.
- Upholstery options: fabric or vinyl
- All units are shipped fully assembled.

### OPTIONAL FEATURES

- Legs are available in 3" and 8" heights with no upcharge. All heights are available with fixed-to-floor option. Please specify. Add \$72. *Fastening hardware not included.*
- Steel bottom provides tamperproof protection (includes tamperproof screws). Specify **(BS)** - see each model for upcharge.\*\*
- Up to two power units are available on straight, Y, curved and boomerang benches.
- Each power unit includes one AC outlet and two USB-a, 10-watt charging ports.
- Power location options include front or back. See electrical placement diagrams. Electrical units must be factory installed. Add \$485 per unit.
- Power units are available in either Jet Black **(J)** or White **(W)** with 120", three-prong matching cords.
- To add sealed seams to your product, specify **(SLS)** - see each model for upcharge.
- To match leg angles with lounge seating, straight front and angled back 6.5" or 8" legs are available on straight, curved, corner, and boomerang units. Specify **(SA)**. No upcharge.
- Products can be weighted to reduce the ease of movement. For additional weight options, specify **(CW)** - see each model for available additional weight and upcharge.
- The underside of the seat can be finished with PVC (vinyl) and sealed to prevent penetration of liquids. Specify **(SP)** - see each model for upcharge.\*

Please add option codes in the following order:

- **Model number**  
R27831 to R27833 Straight benches  
R27834 to R27835 Curved benches  
R27836 to R27839 Corner benches  
R27840 to R27841 Boomerang benches  
R27842 Y bench  
R27843 to R27846 Round non-linking benches  
R27847 to R27850 Square non-linking benches
- **Textile**  
Specify textile code.
- **Leg selection**  
**(S6)** Standard seat height (17.5"), 6.5" leg w/ adjustable glides. No upcharge.  
**(S3)** Low seat (14"), 3" leg w/adjustable glides. No upcharge.  
**(S8)** High seat (19"), 8" leg w/adjustable glides. No upcharge.  
**(F6)** Standard seat height (17.5"), 6.5" leg, fixed to floor. Add \$72.  
**(F3)** Low seat (14"), 3" leg, fixed to floor. Add \$72.  
**(F8)** High seat (19"), 8" leg, fixed to floor. Add \$72.
- **Leg angle**  
**(AST)** Straight legs. No upcharge.  
**(SA)** Straight front legs, angled back legs (available only for 6.5" and 8" high legs on straight, curved, corner and boomerang units). No upcharge.
- **Leg finish**  
**(CH)** Chrome. No upcharge.  
**(BK)** Black. No upcharge.  
**(LT)** Latte. No upcharge.  
**(TU)** Tungsten. No upcharge.
- **Additional weight**  
**(CW)** Additional weight. Upcharges vary, see model.
- **Bottom selection**  
**(SSB)** Standard bottom.  
**(SP)** Vinyl sealed bottom w/staple strip. Upcharges vary, see model.\*  
**(BS)** Steel bottom. Upcharges vary, see model.\*\*
- **Sealed seams**  
**(SLS)** Sealed seams. Upcharges vary, see model.
- **Moisture barrier**  
**(MB)** Upcharges vary, see model.
- **Power/USB unit position** (straight, curved, boomerang and Y benches only, as shown below). Add \$485 per unit.  
**(NP)** No power (no upcharge)  
**(F1)** Front left  
**(F2)** Front right  
**(EB1)** Back left  
**(EB2)** Back right
- **Power unit finish**  
**(J)** Jet Black  
**(W)** White
- **Tamperproof fasteners**  
**(TP)** Upcharges vary, see model.

### ELECTRICAL PLACEMENT

#### Straight benches

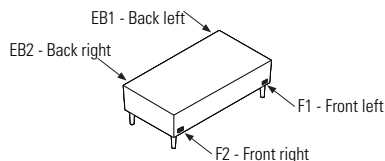

#### Y bench

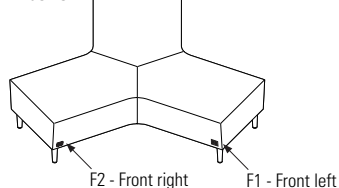

#### Curved benches

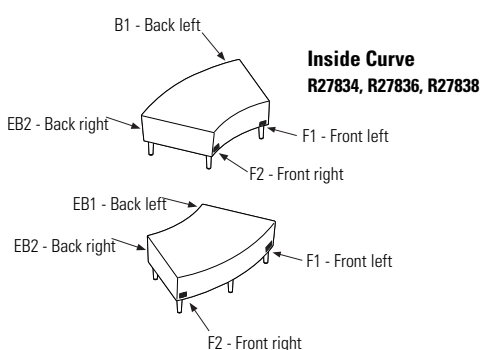

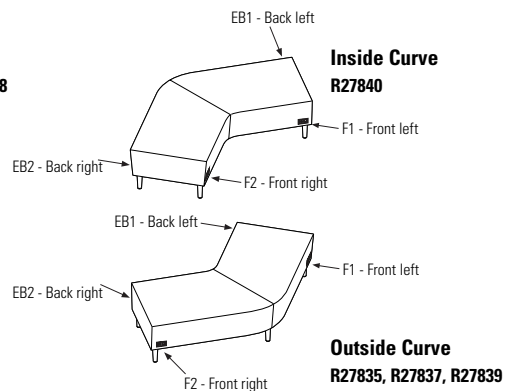

#### Boomerang benches

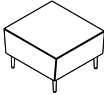
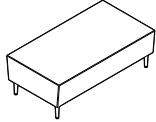
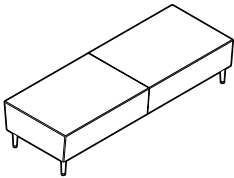
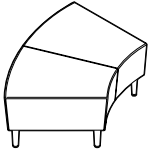
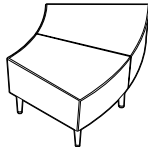

DESCRIPTION	FEATURES	MODEL#	STANDARD TEXTILE GRADES														
			1	2	3	4	5	6	7	8	9	10	11	12			
 <p><b>Single Seater Bench</b> COM Yardage: 1.75 Freight class: 1.75 Product weight: 48 Cubic feet per carton: 10.50</p>	<p>For power/USB unit, see electrical placement chart.</p> <p>Includes ganging hardware (2 sides).</p> <p>Add \$49 for (SLS) Add \$72 for (F6, F3, or F8) Add \$463 for 36 lbs. (CW) Add \$58 for (SP) or \$268 for (BS) Add \$28 for (TP) Add \$92 for (MB)</p>	R27831	977	1030	1073	1137	1227	1269	1351	1481	1582	1694	1924	2169			
			OVERALL DIMENSIONS			SEAT DIMENSIONS			BACK DIMENSIONS								
			W	D	H	W	D	H	W	H							
			26	28.5	17.5	-	-	-	-	-							
			RTA 00			1 per carton											
 <p><b>Two Seater Bench</b> COM Yardage: 2.75 Freight class: 250 Product weight: 65 Cubic feet per carton: 20.50</p>	<p>For power/USB unit, see electrical placement chart.</p> <p>Includes ganging hardware (2 sides).</p> <p>Add \$60 for (SLS) Add \$72 for (F6, F3, or F8) Add \$926 for 72 lbs. (CW) Add \$90 for (SP) or \$446 for (BS) Add \$28 for (TP) Add \$183 for (MB)</p>	R27832	1430	1509	1573	1667	1802	1865	1987	2181	2331	2497	2840	3206			
			OVERALL DIMENSIONS			SEAT DIMENSIONS			BACK DIMENSIONS								
			W	D	H	W	D	H	W	H							
			52	28.5	17.5	-	-	-	-	-							
			RTA 00			1 per carton											
 <p><b>Three Seater Bench</b> COM Yardage: 4.50 Freight class: 4.50 Product weight: 103 Cubic feet per carton: 30.25</p>	<p>For power/USB unit, see electrical placement chart.</p> <p>Includes ganging hardware (2 sides).</p> <p>Add \$88 for (SLS) Add \$72 for (F6, F3, or F8) Add \$926 for 72 lbs. (CW) Add \$126 for (SP) or \$567 for (BS) Add \$28 for (TP) Add \$275 for (MB)</p>	R27833	2249	2385	2494	2657	2889	2998	3207	3542	3800	4086	4676	5305			
			OVERALL DIMENSIONS			SEAT DIMENSIONS			BACK DIMENSIONS								
			W	D	H	W	D	H	W	H							
			78	28.5	17.5	-	-	-	-	-							
			RTA 00			1 per carton											
 <p><b>Inside Curve Two Seater Bench</b> COM Yardage: 3 Freight class: 250 Product weight: 60 Cubic feet per carton: 22.75</p>	<p>For power/USB unit, see electrical placement chart.</p> <p>Includes ganging hardware (2 sides).</p> <p>Add \$54 for (SLS) Add \$72 for (F6, F3, or F8) Add \$926 for 72 lbs. (CW) Add \$90 for (SP) or \$357 for (BS) Add \$35 for (TP) Add \$183 for (MB)</p>	R27834	1942	2033	2106	2215	2370	2442	2582	2806	2978	3169	3564	3984			
			OVERALL DIMENSIONS			SEAT DIMENSIONS			BACK DIMENSIONS								
			W	D	H	W	D	H	W	H							
			50	30.5	17.5	-	-	-	-	-							
			RTA 00			1 per carton											
 <p><b>Outside Curve Two Seater Bench</b> COM Yardage: 3 Freight class: 250 Product weight: 60 Cubic feet per carton: 22.75</p>	<p>For power/USB unit, see electrical placement chart.</p> <p>Includes ganging hardware (2 sides).</p> <p>Add \$54 for (SLS) Add \$72 for (F6, F3, or F8) Add \$926 for 72 lbs. (CW) Add \$90 for (SP) or \$357 for (BS) Add \$35 for (TP) Add \$183 for (MB)</p>	R27835	1942	2033	2106	2215	2370	2442	2582	2806	2978	3169	3564	3984			
			OVERALL DIMENSIONS			SEAT DIMENSIONS			BACK DIMENSIONS								
			W	D	H	W	D	H	W	H							
			50	30.5	17.5	-	-	-	-	-							
			RTA 00			1 per carton											

Options: (SLS) Sealed seams (F6, F3, F8) Floor mount legs (CW) Counterweight (SP) Vinyl sealed bottom (BS) Steel bottom (TP) Tamperproof (MB) Moisture barrier

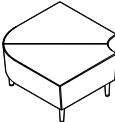
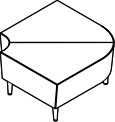

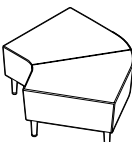
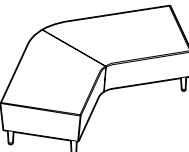
DESCRIPTION	FEATURES	MODEL#	STANDARD TEXTILE GRADES													
			1	2	3	4	5	6	7	8	9	10	11	12		
 <p><b>90° Inside Curve Corner Bench</b> COM Yardage: 3.25 Freight class: 250 Product weight: 60 Cubic feet per carton: 17.25</p>	<p>For power/USB unit, see electrical placement chart.</p> <p>Includes ganging hardware (2 sides).</p> <p>Add \$54 for <b>(SLS)</b> Add \$72 for <b>(F6, F3, or F8)</b> Add \$463 for 36 lbs. <b>(CW)</b> Add \$105 for <b>(SP)</b> or \$415 for <b>(BS)</b> Add \$35 for <b>(TP)</b> Add \$183 for <b>(MB)</b></p>	<b>R27836</b>	1938	2036	2115	2233	2400	2479	2630	2872	3058	3265	3691	4146		
		<b>OVERALL DIMENSIONS</b>			<b>SEAT DIMENSIONS</b>			<b>BACK DIMENSIONS</b>								
		<b>W</b>	<b>D</b>	<b>H</b>	<b>W</b>	<b>D</b>	<b>H</b>	<b>W</b>	<b>H</b>							
		36.5	36.5	17.5	-	-	-	-	-							
		<b>RTA 00</b>	1 per carton													
 <p><b>90° Outside Curve Corner Bench</b> COM Yardage: 3.25 Freight class: 250 Product weight: 60 Cubic feet per carton: 17.25</p>	<p>For power/USB unit, see electrical placement chart.</p> <p>Includes ganging hardware (2 sides).</p> <p>Add \$54 for <b>(SLS)</b> Add \$72 for <b>(F6, F3, or F8)</b> Add \$463 for 36 lbs. <b>(CW)</b> Add \$105 for <b>(SP)</b> or \$415 for <b>(BS)</b> Add \$35 for <b>(TP)</b> Add \$183 for <b>(MB)</b></p>	<b>R27837</b>	1938	2036	2115	2233	2400	2479	2630	2872	3058	3265	3691	4146		
		<b>OVERALL DIMENSIONS</b>			<b>SEAT DIMENSIONS</b>			<b>BACK DIMENSIONS</b>								
		<b>W</b>	<b>D</b>	<b>H</b>	<b>W</b>	<b>D</b>	<b>H</b>	<b>W</b>	<b>H</b>							
		36.5	36.5	17.5	-	-	-	-	-							
		<b>RTA 00</b>	1 per carton													
 <p><b>120° Inside Curve Corner Bench</b> COM Yardage: 3.50 Freight class: 250 Product weight: 57 Cubic feet per carton: 26.75</p>	<p>For power/USB unit, see electrical placement chart.</p> <p>Includes ganging hardware (2 sides).</p> <p>Add \$57 for <b>(SLS)</b> Add \$72 for <b>(F6, F3, or F8)</b> Add \$463 for 36 lbs. <b>(CW)</b> Add \$100 for <b>(SP)</b> or \$456 for <b>(BS)</b> Add \$35 for <b>(TP)</b> Add \$183 for <b>(MB)</b></p>	<b>R27838</b>	1938	2044	2129	2256	2436	2520	2684	2944	3144	3367	3826	4315		
		<b>OVERALL DIMENSIONS</b>			<b>SEAT DIMENSIONS</b>			<b>BACK DIMENSIONS</b>								
		<b>W</b>	<b>D</b>	<b>H</b>	<b>W</b>	<b>D</b>	<b>H</b>	<b>W</b>	<b>H</b>							
		36.5	51.5	17.5	-	-	-	-	-							
		<b>RTA 00</b>	1 per carton													
 <p><b>120° Outside Curve Corner Bench</b> COM Yardage: 3.50 Freight class: 250 Product weight: 57 Cubic feet per carton: 26.75</p>	<p>For power/USB unit, see electrical placement chart.</p> <p>Includes ganging hardware (2 sides).</p> <p>Add \$57 for <b>(SLS)</b> Add \$72 for <b>(F6, F3, or F8)</b> Add \$463 for 36 lbs. <b>(CW)</b> Add \$100 for <b>(SP)</b> or \$456 for <b>(BS)</b> Add \$35 for <b>(TP)</b> Add \$183 for <b>(MB)</b></p>	<b>R27839</b>	1938	2044	2129	2256	2436	2520	2684	2944	3144	3367	3826	4315		
		<b>OVERALL DIMENSIONS</b>			<b>SEAT DIMENSIONS</b>			<b>BACK DIMENSIONS</b>								
		<b>W</b>	<b>D</b>	<b>H</b>	<b>W</b>	<b>D</b>	<b>H</b>	<b>W</b>	<b>H</b>							
		36.5	51.5	17.5	-	-	-	-	-							
		<b>RTA 00</b>	1 per carton													
 <p><b>Inside Curve Boomerang Bench</b> COM Yardage: 5.25 Freight class: 250 Product weight: 126 Cubic feet per carton: 47.75</p>	<p>For power/USB unit, see electrical placement chart.</p> <p>Includes ganging hardware (2 sides).</p> <p>Add \$84 for <b>(SLS)</b> Add \$72 for <b>(F6, F3, or F8)</b> Add \$926 for 72 lbs. <b>(CW)</b> Add \$147 for <b>(SP)</b> or \$802 for <b>(BS)</b> Add \$35 for <b>(TP)</b> Add \$275 for <b>(MB)</b></p>	<b>R27840</b>	2998	3157	3284	3474	3744	3871	4116	4506	4807	5141	5829	6563		
		<b>OVERALL DIMENSIONS</b>			<b>SEAT DIMENSIONS</b>			<b>BACK DIMENSIONS</b>								
		<b>W</b>	<b>D</b>	<b>H</b>	<b>W</b>	<b>D</b>	<b>H</b>	<b>W</b>	<b>H</b>							
		82	45	17.5	-	-	-	-	-							
		<b>RTA 00</b>	1 per carton													

Options: **(SLS)** Sealed seams  
**(F6, F3, F8)** Floor mount legs  
**(CW)** Counterweight  
**(SP)** Vinyl sealed bottom  
**(BS)** Steel bottom  
**(TP)** Tamperproof  
**(MB)** Moisture barrier



DESCRIPTION FEATURES MODEL# STANDARD TEXTILE GRADES

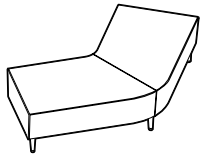

**Outside Curve Boomerang Bench**  
 COM Yardage: 5.25  
 Freight class: 250  
 Product weight: 126  
 Cubic feet per carton: 47.75

For power/USB unit, see electrical placement chart.

Includes ganging hardware (2 sides).

Add \$84 for (SLS)  
 Add \$72 for (F6, F3, or F8)  
 Add \$926 for 72 lbs. (CW)  
 Add \$147 for (SP) or \$802 for (BS)  
 Add \$35 for (TP)  
 Add \$275 for (MB)

MODEL#	STANDARD TEXTILE GRADES											
	1	2	3	4	5	6	7	8	9	10	11	12
R27841	2998	3157	3284	3474	3744	3871	4116	4506	4807	5141	5829	6563
OVERALL DIMENSIONS			SEAT DIMENSIONS			BACK DIMENSIONS						
W	D	H	W	D	H	W	H					
82	45	17.5	-	-	-	-	-					
RTA 00		1 per carton										

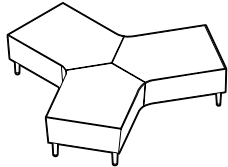

**Y Bench**  
 COM Yardage: 8  
 Freight class: 250  
 Product weight: 203  
 Cubic feet per carton: 101.2

For power/USB unit, see electrical placement chart.

Includes ganging hardware (2 sides).

Add \$141 for (SLS)  
 Add \$72 for (F6, F3, or F8)  
 Add \$695 for 54 lbs. (CW)  
 Add \$221 for (SP) or \$996 for (BS)  
 Add \$49 for (TP)  
 Add \$366 for (MB)

MODEL#	STANDARD TEXTILE GRADES											
	1	2	3	4	5	6	7	8	9	10	11	12
R27842	4828	5070	5263	5554	5965	6159	6532	7126	7584	8093	9142	10260
OVERALL DIMENSIONS			SEAT DIMENSIONS			BACK DIMENSIONS						
W	D	H	W	D	H	W	H					
82	70	17.5	-	-	-	-	-					
RTA 00		1 per carton										



**18" Dia. Round Bench**  
 COM Yardage: 1  
 Freight class: 150  
 Product weight: 25  
 Cubic feet per carton: 4.70

No power/USB unit.

Freestanding unit only.

Add \$32 for (SLS)  
 Add \$72 for (F6, F3, or F8)  
 Not available (CW)  
 Add \$84 for (SP), (BS) not available  
 Add \$28 for (TP)  
 Add \$92 for (MB)

MODEL#	STANDARD TEXTILE GRADES											
	1	2	3	4	5	6	7	8	9	10	11	12
R27843	598	630	654	690	742	766	812	887	944	1008	1139	1279
OVERALL DIMENSIONS			SEAT DIMENSIONS			BACK DIMENSIONS						
W	D	H	W	D	H	W	H					
18	18	17.5	-	-	-	-	-					
RTA 00		1 per carton										

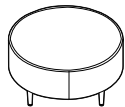

**36" Dia. Round Bench**  
 COM Yardage: 3.25  
 Freight class: 250  
 Product weight: 50  
 Cubic feet per carton: 18.25

No power/USB unit.

Freestanding unit only.

Add \$49 for (SLS)  
 Add \$72 for (F6, F3, or F8)  
 Add \$463 for 36 lbs. (CW)  
 Add \$132 for (SP) or \$456 for (BS)  
 Add \$28 for (TP)  
 Add \$92 for (MB)

MODEL#	STANDARD TEXTILE GRADES											
	1	2	3	4	5	6	7	8	9	10	11	12
R27844	1435	1534	1613	1731	1898	1977	2129	2371	2558	2765	3192	3648
OVERALL DIMENSIONS			SEAT DIMENSIONS			BACK DIMENSIONS						
W	D	H	W	D	H	W	H					
36	36	17.5	-	-	-	-	-					
RTA 00		1 per carton										

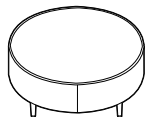

**42" Dia. Round Bench**  
 COM Yardage: 3.50  
 Freight class: 250  
 Product weight: 55  
 Cubic feet per carton: 23

No power/USB unit.

Freestanding unit only.

Add \$54 for (SLS)  
 Add \$72 for (F6, F3, or F8)  
 Add \$926 for 72 lbs. (CW)  
 Add \$147 for (SP) or \$504 for (BS)  
 Add \$28 for (TP)  
 Add \$183 for (MB)

MODEL#	STANDARD TEXTILE GRADES											
	1	2	3	4	5	6	7	8	9	10	11	12
R27845	1651	1758	1843	1971	2151	2236	2400	2661	2862	3085	3546	4037
OVERALL DIMENSIONS			SEAT DIMENSIONS			BACK DIMENSIONS						
W	D	H	W	D	H	W	H					
42	42	17.5	-	-	-	-	-					
RTA 00		1 per carton										

Options: (SLS) Sealed seams  
 (F6, F3, F8) Floor mount legs  
 (CW) Counterweight

(SP) Vinyl sealed bottom  
 (BS) Steel bottom  
 (TP) Tamperproof  
 (MB) Moisture barrier

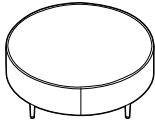
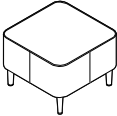
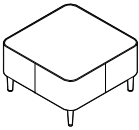
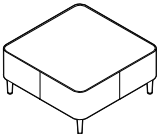
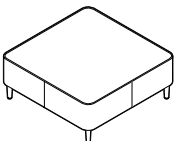
DESCRIPTION	FEATURES	MODEL#	STANDARD TEXTILE GRADES											
			1	2	3	4	5	6	7	8	9	10	11	12
 <p><b>48" Dia. Round Bench</b> COM Yardage: 3.75 Freight class: 250 Product weight: 65 Cubic feet per carton: 30</p>	<p>No power/USB unit.</p> <p>Freestanding unit only.</p> <p>Add \$60 for <b>(SLS)</b> Add \$72 for <b>(F6, F3, or F8)</b> Add \$926 for 72 lbs. <b>(CW)</b> Add \$163 for <b>(SP)</b> or \$535 for <b>(BS)</b> Add \$28 for <b>(TP)</b> Add \$275 for <b>(MB)</b></p>	<b>R27846</b>	1861	1975	2065	2201	2394	2485	2660	2938	3153	3392	3883	4408
			<b>OVERALL DIMENSIONS</b>			<b>SEAT DIMENSIONS</b>			<b>BACK DIMENSIONS</b>					
			<b>W</b>	<b>D</b>	<b>H</b>	<b>W</b>	<b>D</b>	<b>H</b>	<b>W</b>	<b>H</b>				
			48	48	17.5	-	-	-	-	-				
			<b>RTA 00</b>	1 per carton										
 <p><b>24" Square Bench</b> COM Yardage: 1.50 Freight class: 250 Product weight: 30 Cubic feet per carton: 8</p>	<p>No power/USB unit.</p> <p>Freestanding unit only.</p> <p>Add \$42 for <b>(SLS)</b> Add \$72 for <b>(F6, F3, or F8)</b> Add \$463 for 36 lbs. <b>(CW)</b> Add \$90 for <b>(SP)</b> or \$205 for <b>(BS)</b> Add \$28 for <b>(TP)</b> Add \$92 for <b>(MB)</b></p>	<b>R27847</b>	818	865	901	955	1033	1069	1139	1250	1336	1432	1629	1838
			<b>OVERALL DIMENSIONS</b>			<b>SEAT DIMENSIONS</b>			<b>BACK DIMENSIONS</b>					
			<b>W</b>	<b>D</b>	<b>H</b>	<b>W</b>	<b>D</b>	<b>H</b>	<b>W</b>	<b>H</b>				
			24	24	17.5	-	-	-	-	-				
			<b>RTA 00</b>	1 per carton										
 <p><b>30" Square Bench</b> COM Yardage: 2.75 Freight class: 250 Product weight: 40 Cubic feet per carton: 12.25</p>	<p>No power/USB unit.</p> <p>Freestanding unit only.</p> <p>Add \$49 for <b>(SLS)</b> Add \$72 for <b>(F6, F3, or F8)</b> Add \$463 for 36 lbs. <b>(CW)</b> Add \$126 for <b>(SP)</b> or \$196 for <b>(BS)</b> Add \$28 for <b>(TP)</b> Add \$92 for <b>(MB)</b></p>	<b>R27848</b>	1080	1165	1231	1331	1472	1539	1667	1871	2029	2204	2565	2949
			<b>OVERALL DIMENSIONS</b>			<b>SEAT DIMENSIONS</b>			<b>BACK DIMENSIONS</b>					
			<b>W</b>	<b>D</b>	<b>H</b>	<b>W</b>	<b>D</b>	<b>H</b>	<b>W</b>	<b>H</b>				
			30	30	17.5	-	-	-	-	-				
			<b>RTA 00</b>	1 per carton										
 <p><b>36" Square Bench</b> COM Yardage: 3 Freight class: 250 Product weight: 50 Cubic feet per carton: 18.25</p>	<p>No power/USB unit.</p> <p>Freestanding unit only.</p> <p>Add \$54 for <b>(SLS)</b> Add \$72 for <b>(F6, F3, or F8)</b> Add \$926 for 72 lbs. <b>(CW)</b> Add \$137 for <b>(SP)</b> or \$336 for <b>(BS)</b> Add \$28 for <b>(TP)</b> Add \$183 for <b>(MB)</b></p>	<b>R27849</b>	1347	1438	1511	1619	1774	1846	1986	2209	2381	2572	2965	3384
			<b>OVERALL DIMENSIONS</b>			<b>SEAT DIMENSIONS</b>			<b>BACK DIMENSIONS</b>					
			<b>W</b>	<b>D</b>	<b>H</b>	<b>W</b>	<b>D</b>	<b>H</b>	<b>W</b>	<b>H</b>				
			36	36	17.5	-	-	-	-	-				
			<b>RTA 00</b>	1 per carton										
 <p><b>42" Square Bench</b> COM Yardage: 3.25 Freight class: 250 Product weight: 60 Cubic feet per carton: 23</p>	<p>No power/USB unit.</p> <p>Freestanding unit only.</p> <p>Add \$61 for <b>(SLS)</b> Add \$72 for <b>(F6, F3, or F8)</b> Add \$926 for 72 lbs. <b>(CW)</b> Add \$152 for <b>(SP)</b> or \$467 for <b>(BS)</b> Add \$28 for <b>(TP)</b> Add \$275 for <b>(MB)</b></p>	<b>R27850</b>	1636	1736	1814	1932	2099	2178	2330	2571	2758	2964	3391	3845
			<b>OVERALL DIMENSIONS</b>			<b>SEAT DIMENSIONS</b>			<b>BACK DIMENSIONS</b>					
			<b>W</b>	<b>D</b>	<b>H</b>	<b>W</b>	<b>D</b>	<b>H</b>	<b>W</b>	<b>H</b>				
			42	42	17.5	-	-	-	-	-				
			<b>RTA 00</b>	1 per carton										

Options: **(SLS)** Sealed seams  
**(F6, F3, F8)** Floor mount legs  
**(CW)** Counterweight  
**(SP)** Vinyl sealed bottom  
**(BS)** Steel bottom  
**(TP)** Tamperproof  
**(MB)** Moisture barrier

RIVER+ TABLES

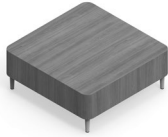

42" Square Coffee Table model R27858



Outside Curve End Table model R27864



18" Dia. Round Laptop Table model 7743

River+ Seating, Benches & Media Hearths

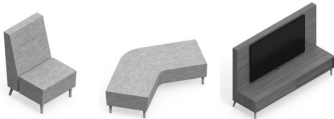

For River+ seating, please see page 324  
 For River+ benches, please see page 331  
 For River+ media hearths, please see page 340

STANDARD FEATURES

- A modular series that is composed of straight and curved sections, as well as freestanding units.
- Linking units can be used together in any combination with River+ seating and bench units to create a wide variety of layouts. Ganging hardware is standard and is factory installed. Ganging hardware swivels out of the way when not in use.
- Front and back faces of end (linking) tables angles slightly inwards. This inward slant matches the inward angles of River seating so all units coordinate in visual appearance.
- The standard 6.5", welded steel legs are straight (vertical) as standard. Linking models are optionally available with an angled back leg to visually align with River+ seating units.
- Legs are standard in Chrome with Black, non-marking, height adjustable glides.
- Tables are made with high pressure laminate. Custom high pressure laminate finishes will be considered upon request.
- Laptop tables have 1" thick laminate tops.
- Laptop table painted metal base finishes are available in Black and Tungsten only.

OPTIONAL FEATURES

- Legs of coffee and end (linking) tables are available in 3" (S3) and 8" (S8) heights. All leg heights are available with fixed-to-floor (F3) and (F8) options. Add \$72.
- To match adjacent lounge seating, straight front and angled back 6.5" or 8" legs are available on linking/end tables. Specify (SA). No upcharge.
- Power units are available on all tables except laptop tables. Each unit includes one AC outlet and two USB-a,10 watt charging ports. Add \$485 upcharge per unit.
- Power location options include top, front or end. See electrical placement diagrams. Electrical units must be factory installed. Add \$485 per unit.
- Power units are available in either Jet Black (J) or White (W) with 120", three-prong matching cords.
- Products can be weighted to reduce the ease of movement. For additional weight options, specify (CW). See each model for available additional weight and upcharge.

Please add option codes in the following order:

- **Model number**  
**R27855 to R27858** Square coffee tables  
**R27859** Rectangular coffee table  
**R27860 to R27861** Round coffee tables  
**R27862 to R27864** Linking/end tables  
**7443 and 7745** Freestanding tables
- **Laminate finishes**  
**(ACJ)** Absolute Acajou **(ASN)** Asian Night  
**(AWC)** Avant Cherry **(AWH)** Avant Honey  
**(BLK)** Black **(BRC)** Brushed Cobalt  
**(CMB)** Clear Maple **(DES)** Dark Espresso  
**(DWT)** Designer White **(HGT)** Hayden Grey  
**(QTM)** Quartered Mahogany  
**(SOG)** Storm Grey **(TFW)** Tiger Fruitwood  
**(TWL)** Tiger Walnut **(WCR)** Winter Cherry  
**(WGY)** Willow Grey **(WCH)** White Chocolate  
**(WHE)** Walnut Heights (colors shown on website)
- **Leg selection**  
**(S6)** Standard height (6.5") w/adjustable glides. No upcharge.  
**(S3)** Low (3") w/adjustable glides. No upcharge.  
**(S8)** High (8") w/adjustable glides. No upcharge.  
**(F6)** Standard height (6.5"), fixed to floor. Add \$72.  
**(F3)** Low (3"), fixed to floor. Add \$72.  
**(F8)** High (8"), fixed to floor. Add \$72.
- **Leg angle** (linking/end tables only)  
**(AST)** Straight legs. No upcharge.  
**(SA)** Straight front legs, angled back legs. No upcharge.
- **Leg finish**  
**(CH)** Chrome. No upcharge.  
**(BK)** Black. No upcharge.  
**(LT)** Latte. No upcharge.  
**(TU)** Tungsten. No upcharge.
- **Additional weight**  
**(CW)** Additional weight. Upcharges vary, see model.
- **Power/USB unit position** (coffee and linking/end tables only, as shown below). Add \$485 per unit.  
**(NP)** No power (no upcharge)  
**(LE1)** Left end (coffee table only)  
**(LE2)** Right end (coffee table only)  
**(F3)** Front center  
**(T1)** Top (coffee table only)
- **Power unit finish**  
**(J)** Jet Black  
**(W)** White
- **(TP)** Tamperproof fasteners. Add \$117.

EXAMPLE RIVER+ TABLE ORDER CODE:

R27858	-ACJ	-S6	-AS	-CM	-	-T1	-W	-
Model number	Laminate	Leg selection	Leg angle	Leg finish	Additional weight	Power/USB	Power finish	Fasteners

ELECTRICAL PLACEMENT

Coffee Tables

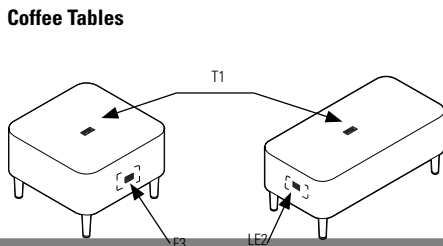

Linking Tables

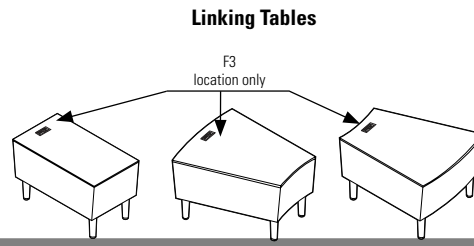

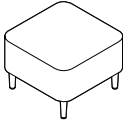
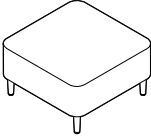
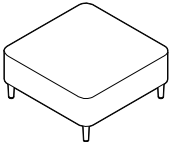
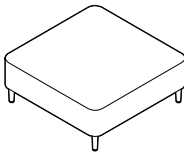
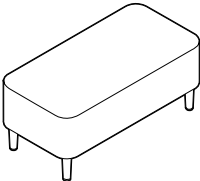
DESCRIPTION	FEATURES	MODEL#	STANDARD TEXTILE GRADES																						
	<p><b>24" Square Coffee Table</b> COM: N/A Freight class: 250 Product weight: 40 Cubic feet per carton: 10.70</p> <p>For power/USB unit, see electrical placement chart.</p> <p>Freestanding unit only. Add \$538 for 36 lbs. <b>(CW)</b></p>	<p><b>R27855</b></p>	List price																						
			1041																						
			<table border="1"> <thead> <tr> <th colspan="3">OVERALL DIMENSIONS</th> <th colspan="3">SEAT DIMENSIONS</th> <th colspan="2">BACK DIMENSIONS</th> </tr> <tr> <th>W</th> <th>D</th> <th>H</th> <th>W</th> <th>D</th> <th>H</th> <th>W</th> <th>H</th> </tr> </thead> <tbody> <tr> <td>24</td> <td>24</td> <td>17</td> <td>-</td> <td>-</td> <td>-</td> <td>-</td> <td>-</td> </tr> </tbody> </table>	OVERALL DIMENSIONS			SEAT DIMENSIONS			BACK DIMENSIONS		W	D	H	W	D	H	W	H	24	24	17	-	-	-
OVERALL DIMENSIONS			SEAT DIMENSIONS			BACK DIMENSIONS																			
W	D	H	W	D	H	W	H																		
24	24	17	-	-	-	-	-																		
	<p><b>30" Square Coffee Table</b> COM: N/A Freight class: 250 Product weight: 53 Cubic feet per carton: 15.30</p> <p>For power/USB unit, see electrical placement chart.</p> <p>Freestanding unit only. Add \$538 for 36 lbs. <b>(CW)</b></p>	<p><b>R27856</b></p>	List price																						
			1098																						
			<table border="1"> <thead> <tr> <th colspan="3">OVERALL DIMENSIONS</th> <th colspan="3">SEAT DIMENSIONS</th> <th colspan="2">BACK DIMENSIONS</th> </tr> <tr> <th>W</th> <th>D</th> <th>H</th> <th>W</th> <th>D</th> <th>H</th> <th>W</th> <th>H</th> </tr> </thead> <tbody> <tr> <td>30</td> <td>30</td> <td>17</td> <td>-</td> <td>-</td> <td>-</td> <td>-</td> <td>-</td> </tr> </tbody> </table>	OVERALL DIMENSIONS			SEAT DIMENSIONS			BACK DIMENSIONS		W	D	H	W	D	H	W	H	30	30	17	-	-	-
OVERALL DIMENSIONS			SEAT DIMENSIONS			BACK DIMENSIONS																			
W	D	H	W	D	H	W	H																		
30	30	17	-	-	-	-	-																		
	<p><b>36" Square Coffee Table</b> COM: N/A Freight class: 250 Product weight: 75 Cubic feet per carton: 20.60</p> <p>For power/USB unit, see electrical placement chart.</p> <p>Freestanding unit only. Add \$1014 for 72 lbs. <b>(CW)</b></p>	<p><b>R27857</b></p>	List price																						
			1258																						
			<table border="1"> <thead> <tr> <th colspan="3">OVERALL DIMENSIONS</th> <th colspan="3">SEAT DIMENSIONS</th> <th colspan="2">BACK DIMENSIONS</th> </tr> <tr> <th>W</th> <th>D</th> <th>H</th> <th>W</th> <th>D</th> <th>H</th> <th>W</th> <th>H</th> </tr> </thead> <tbody> <tr> <td>36</td> <td>36</td> <td>17</td> <td>-</td> <td>-</td> <td>-</td> <td>-</td> <td>-</td> </tr> </tbody> </table>	OVERALL DIMENSIONS			SEAT DIMENSIONS			BACK DIMENSIONS		W	D	H	W	D	H	W	H	36	36	17	-	-	-
OVERALL DIMENSIONS			SEAT DIMENSIONS			BACK DIMENSIONS																			
W	D	H	W	D	H	W	H																		
36	36	17	-	-	-	-	-																		
	<p><b>42" Square Coffee Table</b> COM: N/A Freight class: 150 Product weight: 115 Cubic feet per carton: 26.70</p> <p>For power/USB unit, see electrical placement chart.</p> <p>Freestanding unit only. Add \$1014 for 72 lbs. <b>(CW)</b></p>	<p><b>R27858</b></p>	List price																						
			1399																						
			<table border="1"> <thead> <tr> <th colspan="3">OVERALL DIMENSIONS</th> <th colspan="3">SEAT DIMENSIONS</th> <th colspan="2">BACK DIMENSIONS</th> </tr> <tr> <th>W</th> <th>D</th> <th>H</th> <th>W</th> <th>D</th> <th>H</th> <th>W</th> <th>H</th> </tr> </thead> <tbody> <tr> <td>42</td> <td>42</td> <td>17</td> <td>-</td> <td>-</td> <td>-</td> <td>-</td> <td>-</td> </tr> </tbody> </table>	OVERALL DIMENSIONS			SEAT DIMENSIONS			BACK DIMENSIONS		W	D	H	W	D	H	W	H	42	42	17	-	-	-
OVERALL DIMENSIONS			SEAT DIMENSIONS			BACK DIMENSIONS																			
W	D	H	W	D	H	W	H																		
42	42	17	-	-	-	-	-																		
	<p><b>Rectangular Coffee Table</b> COM: N/A Freight class: 250 Product weight: 55 Cubic feet per carton: 14.20</p> <p>For power/USB unit, see electrical placement chart.</p> <p>Freestanding unit only. Add \$538 for 36 lbs. <b>(CW)</b></p>	<p><b>R27859</b></p>	List price																						
			1141																						
			<table border="1"> <thead> <tr> <th colspan="3">OVERALL DIMENSIONS</th> <th colspan="3">SEAT DIMENSIONS</th> <th colspan="2">BACK DIMENSIONS</th> </tr> <tr> <th>W</th> <th>D</th> <th>H</th> <th>W</th> <th>D</th> <th>H</th> <th>W</th> <th>H</th> </tr> </thead> <tbody> <tr> <td>40</td> <td>20</td> <td>17</td> <td>-</td> <td>-</td> <td>-</td> <td>-</td> <td>-</td> </tr> </tbody> </table>	OVERALL DIMENSIONS			SEAT DIMENSIONS			BACK DIMENSIONS		W	D	H	W	D	H	W	H	40	20	17	-	-	-
OVERALL DIMENSIONS			SEAT DIMENSIONS			BACK DIMENSIONS																			
W	D	H	W	D	H	W	H																		
40	20	17	-	-	-	-	-																		

Options: **(CW)** Counterweight

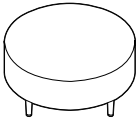
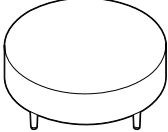
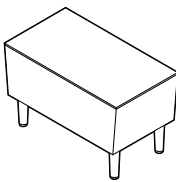
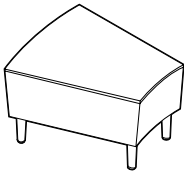
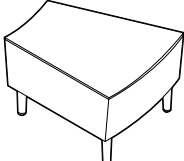
DESCRIPTION	FEATURES	MODEL#	STANDARD TEXTILE GRADES							
		List price								
		<b>R27860</b>	1354							
			<b>OVERALL DIMENSIONS</b>			<b>SEAT DIMENSIONS</b>			<b>BACK DIMENSIONS</b>	
			<b>W</b>	<b>D</b>	<b>H</b>	<b>W</b>	<b>D</b>	<b>H</b>	<b>W</b>	<b>H</b>
			36	36	17	-	-	-	-	-
<b>36" Dia. Round Coffee Table</b> COM: N/A Freight class: 150 Product weight: 63 Cubic feet per carton: 15.30	For power/USB unit, see electrical placement chart.  Freestanding unit only. Add \$538 for 36 lbs. <b>(CW)</b>	<b>RTA 00</b>	1 per carton							
		List price								
		<b>R27861</b>	1484							
			<b>OVERALL DIMENSIONS</b>			<b>SEAT DIMENSIONS</b>			<b>BACK DIMENSIONS</b>	
			<b>W</b>	<b>D</b>	<b>H</b>	<b>W</b>	<b>D</b>	<b>H</b>	<b>W</b>	<b>H</b>
			42	42	17	-	-	-	-	-
<b>42" Dia. Round Coffee Table</b> COM: N/A Freight class: 150 Product weight: 85 Cubic feet per carton: 20.60	For power/USB unit, see electrical placement chart.  Freestanding unit only. Add \$1014 for 72 lbs. <b>(CW)</b>	<b>RTA 00</b>	1 per carton							
		List price								
		<b>R27862</b>	1108							
			<b>OVERALL DIMENSIONS</b>			<b>SEAT DIMENSIONS</b>			<b>BACK DIMENSIONS</b>	
			<b>W</b>	<b>D</b>	<b>H</b>	<b>W</b>	<b>D</b>	<b>H</b>	<b>W</b>	<b>H</b>
			28	15	17	-	-	-	-	-
<b>Rectangular End Table</b> COM: N/A Freight class: 300 Product weight: 40 Cubic feet per carton: 20.60	For power/USB unit, see electrical placement chart.  Includes ganging hardware (2 sides). Add \$292 for 18 lbs. <b>(CW)</b>	<b>RTA 00</b>	1 per carton							
		List price								
		<b>R27863</b>	1456							
			<b>OVERALL DIMENSIONS</b>			<b>SEAT DIMENSIONS</b>			<b>BACK DIMENSIONS</b>	
			<b>W</b>	<b>D</b>	<b>H</b>	<b>W</b>	<b>D</b>	<b>H</b>	<b>W</b>	<b>H</b>
			28	17	17	-	-	-	-	-
<b>Inside Curve End Table</b> COM: N/A Freight class: 250 Product weight: 47 Cubic feet per carton: 13.30	For power/USB unit, see electrical placement chart.  Includes ganging hardware (2 sides). Add \$292 for 18 lbs. <b>(CW)</b>	<b>RTA 00</b>	1 per carton							
		List price								
		<b>R27864</b>	1456							
			<b>OVERALL DIMENSIONS</b>			<b>SEAT DIMENSIONS</b>			<b>BACK DIMENSIONS</b>	
			<b>W</b>	<b>D</b>	<b>H</b>	<b>W</b>	<b>D</b>	<b>H</b>	<b>W</b>	<b>H</b>
			28	17	17	-	-	-	-	-
<b>Outside Curve End Table</b> COM: N/A Freight class: 250 Product weight: 47 Cubic feet per carton: 13.30	For power/USB unit, see electrical placement chart.  Includes ganging hardware (2 sides). Add \$292 for 18 lbs. <b>(CW)</b>	<b>RTA 00</b>	1 per carton							

Options: **(CW)** Counterweight

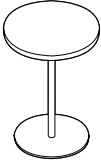
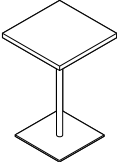
DESCRIPTION	FEATURES	MODEL#	STANDARD TEXTILE GRADES																																
 <p><b>18" Dia. Round Laptop Table</b>                      COM: N/A                      Freight class: 150                      Product weight: 32                      Cubic feet per carton: 6</p>	<p>No power/USB unit.</p> <p>Base only available in Black or Tungsten finish.</p>	List price																																	
		7743	556																																
		<table border="1"> <thead> <tr> <th colspan="3">OVERALL DIMENSIONS</th> <th colspan="3">SEAT DIMENSIONS</th> <th colspan="2">BACK DIMENSIONS</th> </tr> <tr> <th>W</th> <th>D</th> <th>H</th> <th>W</th> <th>D</th> <th>H</th> <th>W</th> <th>H</th> </tr> </thead> <tbody> <tr> <td>18</td> <td>18</td> <td>25.25</td> <td>-</td> <td>-</td> <td>-</td> <td>-</td> <td>-</td> </tr> </tbody> </table>			OVERALL DIMENSIONS			SEAT DIMENSIONS			BACK DIMENSIONS		W	D	H	W	D	H	W	H	18	18	25.25	-	-	-	-	-	<table border="1"> <thead> <tr> <th colspan="2">RTA 00</th> </tr> </thead> <tbody> <tr> <td>1</td> <td>per carton</td> </tr> </tbody> </table>			RTA 00		1	per carton
		OVERALL DIMENSIONS			SEAT DIMENSIONS			BACK DIMENSIONS																											
W	D	H	W	D	H	W	H																												
18	18	25.25	-	-	-	-	-																												
RTA 00																																			
1	per carton																																		
 <p><b>16" Square Laptop Table</b>                      COM: N/A                      Freight class: 125                      Product weight: 36                      Cubic feet per carton: 6</p>	<p>No power/USB unit.</p> <p>Base only available in Black or Tungsten finish.</p>	List price																																	
		7745	544																																
		<table border="1"> <thead> <tr> <th colspan="3">OVERALL DIMENSIONS</th> <th colspan="3">SEAT DIMENSIONS</th> <th colspan="2">BACK DIMENSIONS</th> </tr> <tr> <th>W</th> <th>D</th> <th>H</th> <th>W</th> <th>D</th> <th>H</th> <th>W</th> <th>H</th> </tr> </thead> <tbody> <tr> <td>16</td> <td>16</td> <td>25.25</td> <td>-</td> <td>-</td> <td>-</td> <td>-</td> <td>-</td> </tr> </tbody> </table>			OVERALL DIMENSIONS			SEAT DIMENSIONS			BACK DIMENSIONS		W	D	H	W	D	H	W	H	16	16	25.25	-	-	-	-	-	<table border="1"> <thead> <tr> <th colspan="2">RTA 00</th> </tr> </thead> <tbody> <tr> <td>1</td> <td>per carton</td> </tr> </tbody> </table>			RTA 00		1	per carton
		OVERALL DIMENSIONS			SEAT DIMENSIONS			BACK DIMENSIONS																											
W	D	H	W	D	H	W	H																												
16	16	25.25	-	-	-	-	-																												
RTA 00																																			
1	per carton																																		

# RIVER+ MEDIA HEARTH

RIVER+ MEDIA HEARTH



Media Hearth with Sliding Laminate Doors - 84" model R27877

River+ Seating, Tables & Benches

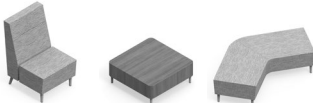

For River+ seating, please see page 324  
 For River+ tables, please see page 336.  
 For River+ benches, please see page 331

# LOUNGE

## STANDARD FEATURES

- A fully finished media center with features and finishes that coordinate with River+ seating, benches and tables. The fully finished back supports ease of planning.
- The 6.5" legs match River+ tapered legs. Legs are straight on the front and angled on the back.
- Legs are standard in Chrome with Black non-marking height adjustable glides.
- Two hidden grommets are standard on the unit. One grommet is centered on the back panel, behind the monitor location. The other is beneath the unit, allowing cables to route from the monitor, through the unit, to the floor.
- Models are available with open shelving or closed, with sliding laminate or glass doors.
- Monitors, mounts and power are not included.
- See Suggested Maximum Monitor Diagonal Sizes chart for recommended maximum dimensions.
- To mount flatscreen or monitor to media hearth, use fixed mounting hardware only; not for use with articulating or extendable arm mounting hardware. Combined weight of mounting hardware and monitor or flatscreen not to exceed 75 lbs.
- Media hearths are made with thermally fused laminates. Specify from the many finishes listed. Custom, high pressure laminate finishes will be considered upon request.

## OPTIONAL FEATURES

- An optional user access grommet is available for the top of the storage shelf, allowing cable routing for user access. Specify center grommet (GP2). Add \$69.
- Optional 6.5" floor mount legs are available. Add \$72. Mounting hardware not included.

Please add option codes in the following order:

- **Model number**  
**R27870 to R27874** Media hearth with open shelf.  
**R27875 to R27879** Media hearth with sliding laminate doors.  
**R27880 to R27884** Media hearth with sliding glass doors.
- **Laminate finishes**  
**(ACJ)** Absolute Acajou **(ASN)** Asian Night  
**(AWC)** Avant Cherry **(AWH)** Avant Honey  
**(BLK)** Black **(BRC)** Brushed Cobalt  
**(CMB)** Clear Maple **(DES)** Dark Espresso  
**(DWT)** Designer White **(HGT)** Hayden Grey  
**(QTM)** Quartered Mahogany  
**(SOG)** Storm Grey **(TFW)** Tiger Fruitwood  
**(TWL)** Tiger Walnut **(WCR)** Winter Cherry  
**(WGY)** Willow Grey **(WHC)** White Chocolate  
**(WHE)** Walnut Heights  
 (colors shown on website)
- **Leg selection**  
**(S6)** Standard height (6.5") w/adjustable glides. No upcharge.  
**(F6)** Standard height (6.5"), floor mount. Add \$72.
- **Leg finish**  
**(CH)** Chrome. No upcharge.  
**(BK)** Black. No upcharge.  
**(LT)** Latte. No upcharge.  
**(TU)** Tungsten. No upcharge.
- **Grommet**  
**(GP2)** Center grommet. Add \$69.

## EXAMPLE RIVER+ MEDIA HEARTH ORDER CODE:

R27870	-ACJ	-S6	-CH	-
Model number	Laminate finish	Leg selection	Leg finish	Grommet

SUGGESTED MAXIMUM MONITOR DIAGONAL SIZES (measurements to be verified by end user)			
Model	Width	Overall usable area	Monitor diagonal dim.
R27870, R27875, R27880	60"	60 W x 37 H	60"
R27871, R27876, R27881	72"	72 W x 37 H	65"
R27872, R27877, R27882	84"	84 W x 37 H	65"
R27873, R27878, R27883	96"	96 W x 37 H	65"
R27874, R27879, R27884	96"	96 W x 37 H	2 x 50"

## GROMMET PLACEMENT

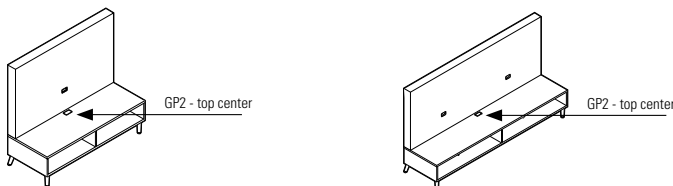

\*Optional grommet is always located in the center of the top of the storage shelf (near the vertical surface).

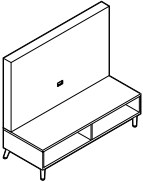
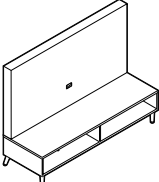
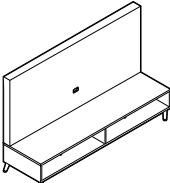
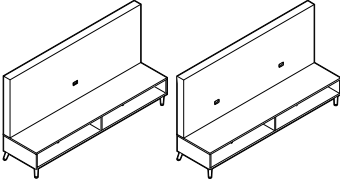
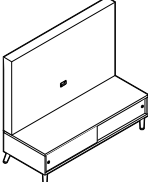
DESCRIPTION	FEATURES	MODEL#	STANDARD TEXTILE GRADES						
 <p><b>Media Hearth with Open Shelf - 60"</b> COM: N/A Freight class: 92.5 Product weight: 170.50 Cubic feet per carton: 14.38</p>			List price						
		<b>R27870</b>	2843						
			<b>OVERALL DIMENSIONS</b>		<b>SEAT DIMENSIONS</b>			<b>BACK DIMENSIONS</b>	
			<b>W</b>	<b>D</b>	<b>H</b>	<b>W</b>	<b>D</b>	<b>H</b>	<b>W</b>
		60	24	54	-	-	-	-	-
			<b>RTA 1</b>	2 cartons					
 <p><b>Media Hearth with Open Shelf - 72"</b> COM: N/A Freight class: 92.5 Product weight: 189 Cubic feet per carton: 17.16</p>			List price						
		<b>R27871</b>	2935						
			<b>OVERALL DIMENSIONS</b>		<b>SEAT DIMENSIONS</b>			<b>BACK DIMENSIONS</b>	
			<b>W</b>	<b>D</b>	<b>H</b>	<b>W</b>	<b>D</b>	<b>H</b>	<b>W</b>
		72	24	54	-	-	-	-	-
			<b>RTA 1</b>	2 cartons					
 <p><b>Media Hearth with Open Shelf - 84"</b> COM: N/A Freight class: 92.5 Product weight: 209 Cubic feet per carton: 19.94</p>			List price						
		<b>R27872</b>	3147						
			<b>OVERALL DIMENSIONS</b>		<b>SEAT DIMENSIONS</b>			<b>BACK DIMENSIONS</b>	
			<b>W</b>	<b>D</b>	<b>H</b>	<b>W</b>	<b>D</b>	<b>H</b>	<b>W</b>
		84	24	54	-	-	-	-	-
			<b>RTA 1</b>	2 cartons					
 <p><b>Media Hearth with Open Shelf - 96"</b> COM: N/A Freight class: 92.5 Product weight: 231.50 Cubic feet per carton: 22.72</p>			List price						
		<b>R27873</b>	3286						
		<b>R27874</b>	3346						
			Dual Monitor						
		<b>OVERALL DIMENSIONS</b>		<b>SEAT DIMENSIONS</b>			<b>BACK DIMENSIONS</b>		
		<b>W</b>	<b>D</b>	<b>H</b>	<b>W</b>	<b>D</b>	<b>H</b>	<b>W</b>	<b>H</b>
		96	24	54	-	-	-	-	-
			<b>RTA 1</b>	2 cartons					
 <p><b>Media Hearth with Sliding Laminate Doors - 60"</b> COM: N/A Freight class: 92.5 Product weight: 170.50 Cubic feet per carton: 14.38</p>			List price						
		<b>R27875</b>	3687						
			<b>OVERALL DIMENSIONS</b>		<b>SEAT DIMENSIONS</b>			<b>BACK DIMENSIONS</b>	
			<b>W</b>	<b>D</b>	<b>H</b>	<b>W</b>	<b>D</b>	<b>H</b>	<b>W</b>
		60	24	54	-	-	-	-	-
			<b>RTA 1</b>	2 cartons					

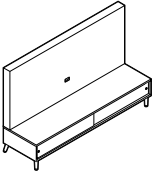
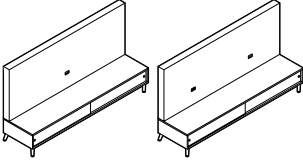

DESCRIPTION	FEATURES	MODEL#	STANDARD TEXTILE GRADES							
 <p><b>Media Hearth with Sliding Laminate Doors - 72"</b> COM: N/A Freight class: 92.5 Product weight: 189 Cubic feet per carton: 17.16</p>			List price							
		<b>R27876</b>	3884							
			<b>OVERALL DIMENSIONS</b>			<b>SEAT DIMENSIONS</b>			<b>BACK DIMENSIONS</b>	
			<b>W</b>	<b>D</b>	<b>H</b>	<b>W</b>	<b>D</b>	<b>H</b>	<b>W</b>	<b>H</b>
		72	24	54	-	-	-	-	-	
					<b>RTA 1</b> 2 cartons					
 <p><b>Media Hearth with Sliding Laminate Doors - 84"</b> COM: N/A Freight class: 92.5 Product weight: 209 Cubic feet per carton: 19.94</p>			List price							
		<b>R27877</b>	4102							
			<b>OVERALL DIMENSIONS</b>			<b>SEAT DIMENSIONS</b>			<b>BACK DIMENSIONS</b>	
			<b>W</b>	<b>D</b>	<b>H</b>	<b>W</b>	<b>D</b>	<b>H</b>	<b>W</b>	<b>H</b>
		84	24	54	-	-	-	-	-	
					<b>RTA 1</b> 2 cartons					
 <p><b>Media Hearth with Sliding Laminate Doors - 96"</b> COM: N/A Freight class: 92.5 Product weight: 231.50 Cubic feet per carton: 22.72</p>			List price							
		<b>R27878</b>	4250							
		<b>R27879</b>	4303							
			Dual Monitor							
			<b>OVERALL DIMENSIONS</b>			<b>SEAT DIMENSIONS</b>			<b>BACK DIMENSIONS</b>	
		<b>W</b>	<b>D</b>	<b>H</b>	<b>W</b>	<b>D</b>	<b>H</b>	<b>W</b>	<b>H</b>	
		96	24	54	-	-	-	-	-	
					<b>RTA 1</b> 2 cartons					
 <p><b>Media Hearth with Sliding Glass Doors - 60"</b> COM: N/A Freight class: 92.5 Product weight: 170.50 Cubic feet per carton: 14.38</p>			List price							
		<b>R27880</b>	3919							
			<b>OVERALL DIMENSIONS</b>			<b>SEAT DIMENSIONS</b>			<b>BACK DIMENSIONS</b>	
			<b>W</b>	<b>D</b>	<b>H</b>	<b>W</b>	<b>D</b>	<b>H</b>	<b>W</b>	<b>H</b>
		60	24	54	-	-	-	-	-	
					<b>RTA 1</b> 2 cartons					
 <p><b>Media Hearth with Sliding Glass Doors - 72"</b> COM: N/A Freight class: 92.5 Product weight: 189 Cubic feet per carton: 17.16</p>			List price							
		<b>R27881</b>	4113							
			<b>OVERALL DIMENSIONS</b>			<b>SEAT DIMENSIONS</b>			<b>BACK DIMENSIONS</b>	
			<b>W</b>	<b>D</b>	<b>H</b>	<b>W</b>	<b>D</b>	<b>H</b>	<b>W</b>	<b>H</b>
		72	24	54	-	-	-	-	-	
					<b>RTA 1</b> 2 cartons					

DESCRIPTION	FEATURES	MODEL#	STANDARD TEXTILE GRADES								
 <p><b>Media Hearth with Sliding Glass Doors - 84"</b>                      COM: N/A                      Freight class: 92.5                      Product weight: 209                      Cubic feet per carton: 19.94</p>			List price								
		<b>R27882</b>	4347								
				<b>OVERALL DIMENSIONS</b>			<b>SEAT DIMENSIONS</b>			<b>BACK DIMENSIONS</b>	
				<b>W</b>	<b>D</b>	<b>H</b>	<b>W</b>	<b>D</b>	<b>H</b>	<b>W</b>	<b>H</b>
			84	24	54	-	-	-	-	-	
						<b>RTA 1</b>		2 cartons			
 <p><b>Media Hearth with Sliding Glass Doors - 96"</b>                      COM: N/A                      Freight class: 92.5                      Product weight: 231.50                      Cubic feet per carton: 22.72</p>			List price								
		<b>R27883</b>	4619								
		<b>R27884</b>	4672	Dual Monitor							
				<b>OVERALL DIMENSIONS</b>			<b>SEAT DIMENSIONS</b>			<b>BACK DIMENSIONS</b>	
			<b>W</b>	<b>D</b>	<b>H</b>	<b>W</b>	<b>D</b>	<b>H</b>	<b>W</b>	<b>H</b>	
			96	24	54	-	-	-	-	-	
						<b>RTA 1</b>		2 cartons			

SIRENA™



models 3371 Lounge Chairs, 3373 Two Seat Sofa, 3400 Coffee Table, and 3402 End Table



model 3371



model 3372CRTL

STITCH DETAIL WHEN UPHOLSTERED IN ALL LEATHER - ILLUSTRATIONS BELOW

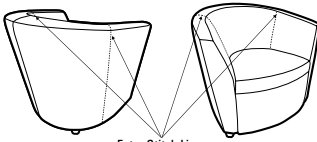

Extra Stitch Lines

Lounge Chair

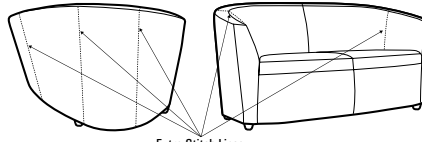

Extra Stitch Lines

Two and Three Seater Sofas



STANDARD FEATURES









- Modern club style seating includes: lounge chair, two and three seat sofas.
- Complete with Modern tables for reception areas, meeting rooms, and private office use.
- Lounge seating distinctive round style feet are finished in Black Only.
- All models have fixed, non-removable seat cushions with arm height at 25" in the front.
- Casters are available on lounge chairs only. C1M casters are standard.
- Please note leather models offer additional stitch details.
- When ordering models with tablet please specify for left hand or for right hand tablet. See models below.
- Laminate Tops, are 1 1/2" thick.
- Table legs are 1 1/2" steel tubing, tapered toward the bottom to 7/8", equipped with self-leveling, pivoting steel glides.



OPTIONAL FEATURES

- For additional Leather options please refer to the Textiles and Finishes section. When ordering, please specify both a Fabric color and Leather color. For example, Match (Grade 2 Fabric) with Prescott Leather (Grade 10). Not available in Crescent, Jenny, or Match.
- Laminate tables, tablets and bookshelves are offered in the following laminate finishes: Absolute Acajou (ACJ), Asian Night (ASN), Avant Cherry (AWC), Avant Honey (AWH), Clear Maple (CMB), Dark Espresso (DES), Designer White (DWT), Hayden Grey (HGT), Tiger Walnut (TWL), Walnut Heights (WHE), White Chocolate (WHC) and Winter Cherry (WCR). Please Specify.
- Table legs are available in Tungsten (TUN), Charcoal (CHR), Black (BLK) at no upcharge. Not available in Chrome.

DESCRIPTION	FEATURES	MODEL#	STANDARD TEXTILE GRADES											
			1	2	3	4	5	6	7	8	9	10	11	12
 <p><b>Lounge Chair</b> Fabric COM Yardage: 4.25 Freight Class: 250 Product Weight (lbs.): 52 Cubic Feet Per Carton: 19.25</p>		<b>3371</b>	-	1215	1302	1432	1617	1687	1848	2153	2305	2587	2979	3464
			<b>OVERALL DIMENSIONS</b>			<b>SEAT DIMENSIONS</b>			<b>BACK DIMENSIONS</b>					
			<b>W</b>	<b>D</b>	<b>H</b>	<b>W</b>	<b>D</b>	<b>H</b>	<b>W</b>	<b>H</b>				
			30.5	29.5	28.5	20	20	17.5	19	11.5				
			<b>RTA 00</b>											
 <p><b>Lounge Chair w/Casters</b> COM Yardage: 4.25 Freight Class: 250 Product Weight (lbs.): 52 Cubic Feet Per Carton: 19.25</p>		<b>3371C</b>	-	1307	1399	1535	1731	1804	1973	2291	2452	2748	3160	3667
			<b>OVERALL DIMENSIONS</b>			<b>SEAT DIMENSIONS</b>			<b>BACK DIMENSIONS</b>					
			<b>W</b>	<b>D</b>	<b>H</b>	<b>W</b>	<b>D</b>	<b>H</b>	<b>W</b>	<b>H</b>				
			30.5	29.5	29.5	20	20	17.5	19	11.5				
			<b>RTA 00</b>											

DESCRIPTION	FEATURES	MODEL#	STANDARD TEXTILE GRADES												
			1	2	3	4	5	6	7	8	9	10	11	12	
 <p><b>3371LTL</b></p> <p><b>Lounge Chair w/Laminate Tablet</b>                      COM Yardage: 4.25                      Freight Class: 250                      Product Weight (lbs.): 58                      Cubic Feet Per Carton: 19.25</p>	 <p><b>3371RTL</b></p>	<p><b>3371LTL</b> 3371RTL</p>	-	1754	1844	1981	2175	2248	2417	2737	2898	3192	3607	4114	
			<p><b>OVERALL DIMENSIONS</b></p> <p>W D H</p>			<p><b>SEAT DIMENSIONS</b></p> <p>W D H</p>			<p><b>BACK DIMENSIONS</b></p> <p>W H</p>						
			32.5	29.5	28.5	20	20	17.5	19	11.5					
<b>RTA 00</b>															
 <p><b>3371CLTL</b></p> <p><b>Lounge Chair w/Casters &amp; Laminate Tablet</b>                      COM Yardage: 4.25                      Freight Class: 150                      Product Weight (lbs.): 62                      Cubic Feet Per Carton: 19.25</p>	 <p><b>3371CRTL</b></p>	<p><b>3371CLTL</b> 3371CRTL</p>	-	1854	1946	2083	2277	2350	2521	2837	2999	3293	3707	4215	
			<p><b>OVERALL DIMENSIONS</b></p> <p>W D H</p>			<p><b>SEAT DIMENSIONS</b></p> <p>W D H</p>			<p><b>BACK DIMENSIONS</b></p> <p>W H</p>						
			32	29.5	29.5	20	20	17.5	19	11.5					
<b>RTA 00</b>															
 <p><b>3372</b></p> <p><b>Lounge Chair w/Laminate Book Shelf</b>                      COM Yardage: 4.25                      Freight Class: 250                      Product Weight (lbs.): 55                      Cubic Feet Per Carton: 19.25</p>			<p><b>3372</b></p>	-	1619	1706	1836	2020	2090	2252	2557	2708	2991	3383	3868
	<p><b>OVERALL DIMENSIONS</b></p> <p>W D H</p>			<p><b>SEAT DIMENSIONS</b></p> <p>W D H</p>			<p><b>BACK DIMENSIONS</b></p> <p>W H</p>								
			30.5	29.5	28.5	20	20	17.5	19	11.5					
<b>RTA 00</b>															
 <p><b>3372C</b></p> <p><b>Lounge Chair w/Casters &amp; Laminate Book Shelf</b>                      COM Yardage: 4.25                      Freight Class: 250                      Product Weight (lbs.): 55                      Cubic Feet Per Carton: 19.25</p>			<p><b>3372C</b></p>	-	1774	1862	1991	2176	2246	2408	2711	2864	3145	3539	4024
	<p><b>OVERALL DIMENSIONS</b></p> <p>W D H</p>			<p><b>SEAT DIMENSIONS</b></p> <p>W D H</p>			<p><b>BACK DIMENSIONS</b></p> <p>W H</p>								
			30.5	29.5	28.5	20	20	17.5	19	11.5					
<b>RTA 00</b>															
 <p><b>3372LTL</b></p> <p><b>Lounge Chair w/Laminate Tablet/Book Shelf</b>                      COM Yardage: 4.25                      Freight Class: 250                      Product Weight (lbs.): 66                      Cubic Feet Per Carton: 19.25</p>	 <p><b>3372RTL</b></p>	<p><b>3372LTL</b> 3372RTL</p>	-	2110	2197	2327	2512	2582	2743	3048	3200	3482	3874	4359	
			<p><b>OVERALL DIMENSIONS</b></p> <p>W D H</p>			<p><b>SEAT DIMENSIONS</b></p> <p>W D H</p>			<p><b>BACK DIMENSIONS</b></p> <p>W H</p>						
			32.5	29.5	28.5	20	20	17.5	19	11.5					
<b>RTA 00</b>															

DESCRIPTION	FEATURES	MODEL#	STANDARD TEXTILE GRADES											
			1	2	3	4	5	6	7	8	9	10	11	12



3372CLTL



3372CRTL

**Lounge Chair w/ Casters & Laminate Tablet/Book Shelf**

COM Yardage: 4.25  
 Freight Class: 250  
 Product Weight (lbs.): 66  
 Cubic Feet Per Carton: 19.25

3372CLTL	-	2214	2302	2431	2616	2686	2847	3152	3304	3587	3978	4463
3372CRTL	-	2214	2302	2431	2616	2686	2847	3152	3304	3587	3978	4463

OVERALL DIMENSIONS			SEAT DIMENSIONS			BACK DIMENSIONS	
W	D	H	W	D	H	W	H

32.5	29.5	28.5	20	20	17.5	19	11.5
------	------	------	----	----	------	----	------

RTA 00

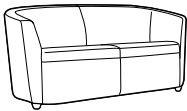

**Two Seat Sofa**

COM Yardage: 7  
 Freight Class: 300  
 Product Weight (lbs.): 92  
 Cubic Feet Per Carton: 48

3373	-	2281	2425	2640	2943	3058	3324	3825	4075	4541	5187	5984
------	---	------	------	------	------	------	------	------	------	------	------	------

OVERALL DIMENSIONS			SEAT DIMENSIONS			BACK DIMENSIONS	
W	D	H	W	D	H	W	H

62	29.5	28.5	53	20	17.5	53	11.5
----	------	------	----	----	------	----	------

RTA 00

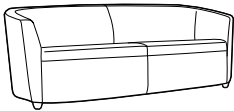

**Three Seat Sofa**

COM Yardage: 7.75  
 Freight Class: 300  
 Product Weight (lbs.): 107  
 Cubic Feet Per Carton: 61.50

3374	-	2742	2901	3138	3474	3602	3897	4451	4728	5243	5958	6841
------	---	------	------	------	------	------	------	------	------	------	------	------

OVERALL DIMENSIONS			SEAT DIMENSIONS			BACK DIMENSIONS	
W	D	H	W	D	H	W	H

81.5	29.5	28.5	72.5	20	17.5	72.5	11.5
------	------	------	------	----	------	------	------

RTA 00

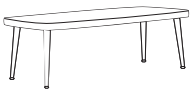

**Coffee Table - 48" Laminate Top**

COM Yardage: N/A  
 Freight Class: 250  
 Product Weight (lbs.): 52  
 Cubic Feet Per Carton: 17.25

3400	1303	-	-	-	-	-	-	-	-	-	-	-
------	------	---	---	---	---	---	---	---	---	---	---	---

OVERALL DIMENSIONS			SEAT DIMENSIONS			BACK DIMENSIONS	
W	D	H	W	D	H	W	H

48	22	15	-	-	-	-	-
----	----	----	---	---	---	---	---

RTA 00



**Coffee Table - 56" Laminate Top**





COM Yardage: N/A  
 Freight Class: 175  
 Product Weight (lbs.): 60  
 Cubic Feet Per Carton: 19.75

3401	1441	-	-	-	-	-	-	-	-	-	-	-
------	------	---	---	---	---	---	---	---	---	---	---	---

OVERALL DIMENSIONS			SEAT DIMENSIONS			BACK DIMENSIONS	
W	D	H	W	D	H	W	H

56	22	15	-	-	-	-	-
----	----	----	---	---	---	---	---

RTA 00

DESCRIPTION	FEATURES	MODEL#	STANDARD TEXTILE GRADES													
			1	2	3	4	5	6	7	8	9	10	11	12		
 <b>End Table - Laminate Top</b> COM Yardage: N/A Freight Class: 250 Product Weight (lbs.): 26  Cubic Feet Per Carton: 7.75		3402	1045	-	-	-	-	-	-	-	-	-	-	-		
	<b>OVERALL DIMENSIONS</b>			<b>SEAT DIMENSIONS</b>			<b>BACK DIMENSIONS</b>									
	<b>W</b>	<b>D</b>	<b>H</b>	<b>W</b>	<b>D</b>	<b>H</b>	<b>W</b>	<b>H</b>								
			17	22	15	-	-	-	-	-						
			<b>RTA 00</b>													
 <b>Coffee Table - 48" MDF Top</b> COM Yardage: N/A Freight Class: 250 Product Weight (lbs.): 38 Cubic Feet Per Carton: 17.25		3406	1586	-	-	-	-	-	-	-	-	-	-	-		
	<b>OVERALL DIMENSIONS</b>			<b>SEAT DIMENSIONS</b>			<b>BACK DIMENSIONS</b>									
	<b>W</b>	<b>D</b>	<b>H</b>	<b>W</b>	<b>D</b>	<b>H</b>	<b>W</b>	<b>H</b>								
			48	22	14.25	-	-	-	-	-						
			<b>RTA 00</b>													
 <b>Coffee Table - 56" MDF Top</b> COM Yardage: N/A Freight Class: 175 Product Weight (lbs.): 102 Cubic Feet Per Carton: 48		3407	1810	-	-	-	-	-	-	-	-	-	-	-		
	<b>OVERALL DIMENSIONS</b>			<b>SEAT DIMENSIONS</b>			<b>BACK DIMENSIONS</b>									
	<b>W</b>	<b>D</b>	<b>H</b>	<b>W</b>	<b>D</b>	<b>H</b>	<b>W</b>	<b>H</b>								
			56	22	14.25	-	-	-	-	-						
			<b>RTA 00</b>													
 <b>End Table - MDF Top</b> COM Yardage: N/A Freight Class: 250 Product Weight (lbs.): 20 Cubic Feet Per Carton: 7.75		3408	1276	-	-	-	-	-	-	-	-	-	-	-		
	<b>OVERALL DIMENSIONS</b>			<b>SEAT DIMENSIONS</b>			<b>BACK DIMENSIONS</b>									
	<b>W</b>	<b>D</b>	<b>H</b>	<b>W</b>	<b>D</b>	<b>H</b>	<b>W</b>	<b>H</b>								
			17	22	14.25	-	-	-	-	-						
			<b>RTA 00</b>													

VITROLA



Vitrola is offered in two back heights, standard lounge and high back lounge, along with two and three seat sofa models.



Matching ottoman and accent pillow to complete the offering.

STANDARD FEATURES

- Classic soft seating upholstery design with swooping arms.
- Available in standard Lounge, High Back Lounge along with Two and Three Seat Sofa models.
- Matching Ottoman and Accent Pillow complete the offering.
- Fully upholstered with piping details at the bottom of frame.
- Seat cushions are fixed or sewn tight.
- Standard in tapered maple wood legs. Standard in tapered maple wood legs. Legs are equipped with White non-marking glides as standard. Suitable for both carpet and hard surface flooring.
- Back upholstery is continuous without seams. In the event the textile cannot be railroaded, stitch lines will be required (one for 2 seater and two for 3 seater).
- All models ship fully assembled.

OPTION CODES



Please add option codes in the following order:

- **Model number**  
**8271** Lounge Chair  
**8272** Two Seat Sofa  
**8273** Three Seat Sofa  
**8274** Ottoman  
**8275** High Back Lounge Chair  
**8276** Accent Pillow
- **Fabric**  
Specify fabric code.
- **Wood Legs**  
**(AA)** Absolute **(AAM)**  
**(BM)** Black **(BKM)**  
**(CM)** Cherry **(ACM)**  
**(EO)** English Oak **(EOM)**  
**(EC)** Espresso Café **(ECM)**  
**(HG)** Grey **(HGM)**  
**(HO)** Honey **(AHM)**  
**(TM)** Mahogany **(TMM)**  
**(VM)** Maple **(AVM)**  
**(MM)** Medium Walnut **(MWM)**  
**(SN)** Night **(ASM)**  
**(SK)** Shaker Cherry **(SKM)**  
**(TF)** Fruitwood **(TFM)**  
**(TW)** Walnut **(TWM)**  
**(WC)** WC Cream **(WTM)**  
**(WH)** White **(WHM)**  
**(WE)** Winter Cherry **(WCM)**  
(colors shown on website).

EXAMPLE OF ORDER CODE:

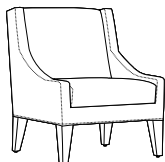
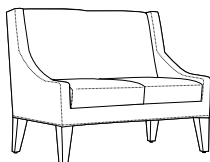
8271	WA50	HG
Model Number	Fabric	Wood Legs

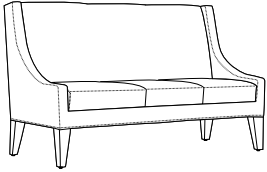
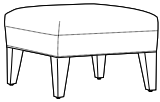
DESCRIPTION	FEATURES	MODEL#	STANDARD TEXTILE GRADES											
			1	2	3	4	5	6	7	8	9	10	11	12
 <p><b>Lounge Chair</b>  COM Yardage: 5.25  Freight Class: 250  Product Weight (lbs.): 80  Cubic Feet Per Carton: 30</p>		<b>8271</b>	1125	1265	1376	1542	1778	1890	2104	2445	2707	3000	3601	4244
			<b>OVERALL DIMENSIONS</b>			<b>SEAT DIMENSIONS</b>			<b>BACK DIMENSIONS</b>					
			<b>W</b>	<b>D</b>	<b>H</b>	<b>W</b>	<b>D</b>	<b>H</b>	<b>W</b>	<b>H</b>				
			28	31	34	22	21	17.5	22	18				
		<b>RTA 00</b>												
 <p><b>Two Seat Sofa</b>  COM Yardage: 7.25  Freight Class: 250  Product Weight (lbs.): 95  Cubic Feet Per Carton: 49</p>		<b>8272</b>	1846	2069	2246	2512	2890	3068	3411	3957	4377	4846	5809	6835
			<b>OVERALL DIMENSIONS</b>			<b>SEAT DIMENSIONS</b>			<b>BACK DIMENSIONS</b>					
			<b>W</b>	<b>D</b>	<b>H</b>	<b>W</b>	<b>D</b>	<b>H</b>	<b>W</b>	<b>H</b>				
			50	31	34	44	21	17.5	44	18				
		<b>RTA 00</b>												

DESCRIPTION	FEATURES	MODEL#	STANDARD TEXTILE GRADES																								
			1	2	3	4	5	6	7	8	9	10	11	12													
 <p><b>Three Seat Sofa</b> COM Yardage: 9.25 Freight Class: 250 Product Weight (lbs.): 125 Cubic Feet Per Carton: 59</p>		<b>8273</b>	2402	2737	3003	3403	3970	4235	4750	5569	6199	6901	8346	9886													
	<table border="1"> <thead> <tr> <th colspan="3">OVERALL DIMENSIONS</th> <th colspan="3">SEAT DIMENSIONS</th> <th colspan="2">BACK DIMENSIONS</th> </tr> <tr> <th>W</th><th>D</th><th>H</th> <th>W</th><th>D</th><th>H</th> <th>W</th><th>H</th> </tr> </thead> <tbody> <tr> <td>71</td><td>31</td><td>34</td> <td>66</td><td>21</td><td>17.5</td> <td>66</td><td>18</td> </tr> </tbody> </table>	OVERALL DIMENSIONS			SEAT DIMENSIONS			BACK DIMENSIONS		W	D	H	W	D	H	W	H	71	31	34	66	21	17.5	66	18	<b>RTA 00</b>	
	OVERALL DIMENSIONS			SEAT DIMENSIONS			BACK DIMENSIONS																				
W	D	H	W	D	H	W	H																				
71	31	34	66	21	17.5	66	18																				
 <p><b>Ottoman</b> COM Yardage: 1.75 Freight Class: 150 Product Weight (lbs.): 15 Cubic Feet Per Carton: 7</p>		<b>8274</b>	645	716	772	854	973	1028	1136	1306	1437	1584	1884	2206													
	<table border="1"> <thead> <tr> <th colspan="3">OVERALL DIMENSIONS</th> <th colspan="3">SEAT DIMENSIONS</th> <th colspan="2">BACK DIMENSIONS</th> </tr> <tr> <th>W</th><th>D</th><th>H</th> <th>W</th><th>D</th><th>H</th> <th>W</th><th>H</th> </tr> </thead> <tbody> <tr> <td>24</td><td>24</td><td>17</td> <td>-</td><td>-</td><td>-</td> <td>-</td><td>-</td> </tr> </tbody> </table>	OVERALL DIMENSIONS			SEAT DIMENSIONS			BACK DIMENSIONS		W	D	H	W	D	H	W	H	24	24	17	-	-	-	-	-	<b>RTA 00</b>	
	OVERALL DIMENSIONS			SEAT DIMENSIONS			BACK DIMENSIONS																				
W	D	H	W	D	H	W	H																				
24	24	17	-	-	-	-	-																				
 <p><b>High Back Lounge Chair</b> COM Yardage: 6.25 Freight Class: 150 Product Weight (lbs.): 85 Cubic Feet Per Carton: 34</p>		<b>8275</b>	1355	1507	1630	1813	2073	2194	2430	2806	3096	3416	4079	4785													
	<table border="1"> <thead> <tr> <th colspan="3">OVERALL DIMENSIONS</th> <th colspan="3">SEAT DIMENSIONS</th> <th colspan="2">BACK DIMENSIONS</th> </tr> <tr> <th>W</th><th>D</th><th>H</th> <th>W</th><th>D</th><th>H</th> <th>W</th><th>H</th> </tr> </thead> <tbody> <tr> <td>28</td><td>31</td><td>42</td> <td>22</td><td>21</td><td>17.5</td> <td>22</td><td>26</td> </tr> </tbody> </table>	OVERALL DIMENSIONS			SEAT DIMENSIONS			BACK DIMENSIONS		W	D	H	W	D	H	W	H	28	31	42	22	21	17.5	22	26	<b>RTA 00</b>	
	OVERALL DIMENSIONS			SEAT DIMENSIONS			BACK DIMENSIONS																				
W	D	H	W	D	H	W	H																				
28	31	42	22	21	17.5	22	26																				
 <p><b>Accent Pillow</b> COM Yardage: 0.75 Freight Class: 70 Product Weight (lbs.): 3 Cubic Feet Per Carton: 2</p>		<b>8276</b>	132	146	157	175	197	209	230	264	290	320	380	444													
	<table border="1"> <thead> <tr> <th colspan="3">OVERALL DIMENSIONS</th> <th colspan="3">SEAT DIMENSIONS</th> <th colspan="2">BACK DIMENSIONS</th> </tr> <tr> <th>W</th><th>D</th><th>H</th> <th>W</th><th>D</th><th>H</th> <th>W</th><th>H</th> </tr> </thead> <tbody> <tr> <td>23</td><td>6</td><td>8</td> <td>-</td><td>-</td><td>-</td> <td>-</td><td>-</td> </tr> </tbody> </table>	OVERALL DIMENSIONS			SEAT DIMENSIONS			BACK DIMENSIONS		W	D	H	W	D	H	W	H	23	6	8	-	-	-	-	-	<b>RTA 00</b>	1 per carton
	OVERALL DIMENSIONS			SEAT DIMENSIONS			BACK DIMENSIONS																				
W	D	H	W	D	H	W	H																				
23	6	8	-	-	-	-	-																				



WIND™



models 3361 Lounge chair & 3362 Two seat sofa, with 3357 Coffee table.

STANDARD FEATURES

- Compact, contemporary design includes a raised modern version of the traditional lounge chair that is scaled down for smaller spaces.
- Chair and table legs is standard in Chrome.
- There are no caster options for the Wind series.
- Wind tables complement the modern decor of many office environments.

OPTIONAL FEATURES

- Chair frames and table legs are available in Tungsten (TUN), Charcoal (CHR) and Black (BLK). Finishes are available at no upcharge.
- Table tops are available in high pressure laminate at a 20% upcharge.
- Not available in Crescent fabric

- Table tops are available in two different materials; MDF tops feature a refined edge with a rounded triangular profile and Epoxy finish. Available in Charcoal (CHR) or White (WHT). Please Specify.
- Laminate tops are offered in the following laminate finishes: Absolute Acajou (ACJ), Asian Night (ASN), Avant Cherry (AWC), Avant Honey (AWH), Black (BLK), Brushed Cobalt (BRC), Clear Maple (CMB), Dark Espresso (DES), Designer White (DWT), Hayden Grey (HGT), Quartered Mahogany (QTM), Storm Grey (SOG), Tiger Fruitwood (TFW), Tiger Walnut (TWN), Walnut Heights (WHE), White Chocolate (WHC), Willow Grey (WGY), and Winter Cherry (WCR). Please Specify.

ADDITIONAL STITCH DETAIL - ILLUSTRATIONS BELOW

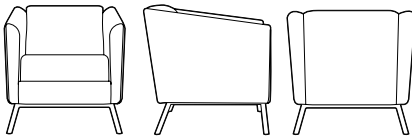

Standard Detailing - when upholstered in FABRIC or VINYL

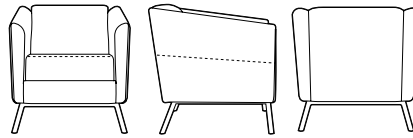

Additional Detailing - when upholstered in LEATHER/MOCK LEATHER

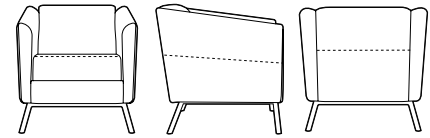

Additional Detailing - when upholstered in GENUINE LEATHER

DESCRIPTION	FEATURES	MODEL#	STANDARD TEXTILE GRADES											
-------------	----------	--------	-------------------------	--	--	--	--	--	--	--	--	--	--	--

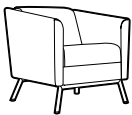

**Lounge Chair**  
COM Yardage: 4.50  
Freight Class: 250  
Product Weight (lbs.): 62  
Cubic Feet Per Carton: 16.50

	1	2	3	4	5	6	7	8	9	10	11	12
<b>3361</b>	-	1788	1883	2025	2226	2302	2479	2810	2978	3284	3712	4242

OVERALL DIMENSIONS			SEAT DIMENSIONS			BACK DIMENSIONS	
W	D	H	W	D	H	W	H
27.5	29	28.5	19.5	19	17	19	12

RTA 00

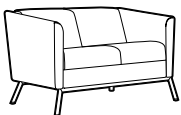

**Two Seat Sofa**  
COM Yardage: 6.75  
Freight Class: 250  
Product Weight (lbs.): 102  
Cubic Feet Per Carton: 41.25

	1	2	3	4	5	6	7	8	9	10	11	12
<b>3362</b>	-	2377	2521	2732	3034	3150	3413	3911	4159	4621	5264	6056

OVERALL DIMENSIONS			SEAT DIMENSIONS			BACK DIMENSIONS	
W	D	H	W	D	H	W	H
54.5	29	28.5	46.5	19	17	46.5	12

RTA 00







**Three Seat Sofa**  
COM Yardage: 9  
Freight Class: 250  
Product Weight (lbs.): 135  
Cubic Feet Per Carton: 55.50

	1	2	3	4	5	6	7	8	9	10	11	12
<b>3363</b>	-	2963	3147	3424	3814	3962	4304	4948	5270	5867	6699	7724

OVERALL DIMENSIONS			SEAT DIMENSIONS			BACK DIMENSIONS	
W	D	H	W	D	H	W	H
78	29	28.5	70.5	19	17	70.5	12

RTA 00

DESCRIPTION	FEATURES	MODEL#	STANDARD TEXTILE GRADES											
			1	2	3	4	5	6	7	8	9	10	11	12
		<b>3356</b>	831	-	-	-	-	-	-	-	-	-	-	-
		MDF Top												
		<b>3366</b>	654	-	-	-	-	-	-	-	-	-	-	-
		Laminate Top												
<b>OVERALL DIMENSIONS</b>			<b>SEAT DIMENSIONS</b>			<b>BACK DIMENSIONS</b>								
<b>W D H</b>			<b>W D H</b>			<b>W H</b>								
24 24 17			- - -			- - -								
<b>RTA 00</b>														
		<b>3357</b>	1080	-	-	-	-	-	-	-	-	-	-	
		MDF Top												
		<b>3367</b>	865	-	-	-	-	-	-	-	-	-	-	
		Laminate Top												
<b>OVERALL DIMENSIONS</b>			<b>SEAT DIMENSIONS</b>			<b>BACK DIMENSIONS</b>								
<b>W D H</b>			<b>W D H</b>			<b>W H</b>								
48 20 15			- - -			- - -								
<b>RTA 00</b>														
		<b>3358</b>	1369	-	-	-	-	-	-	-	-	-	-	
		MDF Top												
		<b>3368</b>	1172	-	-	-	-	-	-	-	-	-	-	
		Laminate Top												
<b>OVERALL DIMENSIONS</b>			<b>SEAT DIMENSIONS</b>			<b>BACK DIMENSIONS</b>								
<b>W D H</b>			<b>W D H</b>			<b>W H</b>								
36 36 15			- - -			- - -								
<b>RTA 00</b>														
		<b>3860</b>	1032	-	-	-	-	-	-	-	-	-	-	
		MDF Top												
		<b>3870</b>	716	-	-	-	-	-	-	-	-	-	-	
		Laminate Top												
<b>OVERALL DIMENSIONS</b>			<b>SEAT DIMENSIONS</b>			<b>BACK DIMENSIONS</b>								
<b>W D H</b>			<b>W D H</b>			<b>W H</b>								
24 24 17			- - -			- - -								
<b>RTA 00</b>														
		<b>3861</b>	1505	-	-	-	-	-	-	-	-	-	-	
		MDF Top												
		<b>3871</b>	1054	-	-	-	-	-	-	-	-	-	-	
		Laminate Top												
<b>OVERALL DIMENSIONS</b>			<b>SEAT DIMENSIONS</b>			<b>BACK DIMENSIONS</b>								
<b>W D H</b>			<b>W D H</b>			<b>W H</b>								
36 36 15			- - -			- - -								
<b>RTA 00</b>														

# W WIND™ LINEAR

WIND™ LINEAR



models 3363R and 3363L with 3882 bridge table, 3360 table attaching bracket kit and two 3380 coffee tables

# LOUNGE

## STANDARD FEATURES

- Wind Linear is an extension of the Wind lounge series with an emphasis on expansive, clean lines. Wind Linear tables complement the modern decor of many offices.
- This modular furniture series includes single arm and armless sofas, benches, bridges and tables
- Seating and freestanding tables can be used as stand-alone products. Seating units can be linked together using bridge tables to create infinite configurations. Note: an upholstered seat unit cannot be linked with another upholstered seat unit.
- Chair and table legs are standard in Chrome.
- There are no caster options for the Wind Linear series.
- Table 'bridges' can mount outside or in-between seats to accommodate various work and collaborative settings. Requires table attaching bracket kit (3360).
- Please note Bridge End Table (model 3882) is only to be used with Chairs and/or Sofa models. Not usable with Bench or Ottoman Models.
- Please note Bridge Table (model 3884) is only to be used with Bench models 3361B and/or Ottoman models 3363B.

## OPTIONAL FEATURES

- Wind linear table models are offered in laminate finishes to coordinate with Global casegoods and wood seating. These tables are not offered in high pressure laminates or epoxy finishes.
- Table tops are available in high pressure laminate at an upcharge. Add 20%.
- Chair and Table legs are available in Tungsten (TUN), Charcoal (CHR) and Black (BLK) finishes at no up charge.

## SAMPLE LAYOUTS

### Layout A



Qty	Model Number	Description	Dimensions	List Price
1	<b>3361R</b>	Single Seater - Right Arm	39.5 x 29 x 28.5	1893
1	<b>3361L</b>	Single Seater - Left Arm	39.5 x 29 x 28.5	1893
1	<b>3363NA</b>	Single Sofa - Armless	72 x 29 x 28.5	2522
1	<b>3881R</b>	Bridge Corner Table - Right	25 x 25 x 12	1223
1	<b>3881L</b>	Bridge Corner Table - Left	25 x 25 x 12	1223
2	<b>3360</b>	Table Bracket Kit - 1 Kit per table		134 x 2

**SAMPLE LAYOUT TOTAL IN STANDARD BLACK FRAME**

**8756**

### Layout B



Qty	Model Number	Description	Dimensions	List Price
1	<b>3361R</b>	Single Seater - Right Arm	39.5 x 29 x 28.5	1893
1	<b>3361L</b>	Single Seater - Left Arm	39.5 x 29 x 28.5	1893
1	<b>3361NA</b>	Single Seater - Armless	36.5 x 29 x 28.5	1673
2	<b>3882</b>	Bridge End Table	25 x 20 x 12	667 x 2
2	<b>3360</b>	Table Bracket Kit - 1 Kit per table		134 x 2

**SAMPLE LAYOUT TOTAL IN STANDARD BLACK FRAME**

**6852**

## DESCRIPTION

## FEATURES

## MODEL#

## STANDARD TEXTILE GRADES

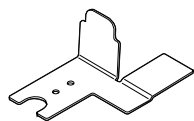

### Table Bracket Kit

COM Yardage: N/A  
 Freight Class: 70  
 Product Weight (lbs.): .01  
 Cubic Feet Per Carton: .01 ( 1 Kit per carton)

Includes 4 brackets and hardware.  
 Use with models 3361R, 3361L, & 3382.





	1	2	3	4	5	6	7	8	9	10	11	12
<b>3360</b>	134	-	-	-	-	-	-	-	-	-	-	-
<b>OVERALL DIMENSIONS</b>			<b>SEAT DIMENSIONS</b>			<b>BACK DIMENSIONS</b>						
<b>W</b>	<b>D</b>	<b>H</b>	<b>W</b>	<b>D</b>	<b>H</b>	<b>W</b>	<b>D</b>	<b>H</b>				
-	-	-	-	-	-	-	-	-				

RTA 00

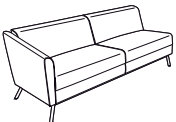

# LOUNGE

# WIND™ LINEAR W

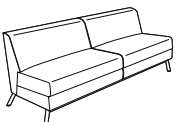
DESCRIPTION	FEATURES	MODEL#	STANDARD TEXTILE GRADES											
			1	2	3	4	5	6	7	8	9	10	11	12
 3361R	 3361L	3361R	-	1893	1991	2137	2343	2420	2600	2940	3110	3427	3865	4407
		3361LLM	-	-	-	-	2382	-	-	2981	-	3466	3921	4462
<b>Single Seater - w/ Left or Right Arm</b> COM Yardage: 4.75 Freight Class: 250 Product Weight (lbs.): 72 Cubic Feet Per Carton: 28.50			<b>RTA 00</b>											
			<b>OVERALL DIMENSIONS</b>			<b>SEAT DIMENSIONS</b>			<b>BACK DIMENSIONS</b>					
			<b>W</b>	<b>D</b>	<b>H</b>	<b>W</b>	<b>D</b>	<b>H</b>	<b>W</b>	<b>D</b>	<b>H</b>	<b>W</b>	<b>H</b>	
			39.5	29	28.5	36	19	17	36		12			
 3361NA		3361NA	-	1673	1741	1841	1982	2036	2159	2391	2506	2724	3025	3393
		3361NALM	-	-	-	-	2024	-	-	2433	-	2766	3078	3447
<b>Single Seater - Armless</b> COM Yardage: 3.25 Freight Class: 250 Product Weight (lbs.): 58 Cubic Feet Per Carton: 28.50			<b>RTA 00</b>											
			<b>OVERALL DIMENSIONS</b>			<b>SEAT DIMENSIONS</b>			<b>BACK DIMENSIONS</b>					
			<b>W</b>	<b>D</b>	<b>H</b>	<b>W</b>	<b>D</b>	<b>H</b>	<b>W</b>	<b>D</b>	<b>H</b>	<b>W</b>	<b>H</b>	
			36.5	29	28.5	36.5	19	17.5	36.5		12			
 3363R	 3363L	3363R	-	2835	2995	3233	3568	3696	3991	4545	4822	5337	6052	6937
		3363LLM	-	-	-	-	3557	-	-	4535	-	5325	6067	6950
<b>Single Sofa - w/ Left or Right Arm</b> COM Yardage: 7.75 Freight Class: 250 Product Weight (lbs.): 120 Cubic Feet Per Carton: 55.50			<b>RTA 00</b>											
			<b>OVERALL DIMENSIONS</b>			<b>SEAT DIMENSIONS</b>			<b>BACK DIMENSIONS</b>					
			<b>W</b>	<b>D</b>	<b>H</b>	<b>W</b>	<b>D</b>	<b>H</b>	<b>W</b>	<b>D</b>	<b>H</b>	<b>W</b>	<b>H</b>	
			75	29	28.5	71	19	17	71		12			
 3363NA		3363NA	-	2522	2655	2855	3137	3244	3490	3955	4188	4620	5220	5961
		3363NALM	-	-	-	-	3223	-	-	4042	-	4706	5328	6068
<b>Single Sofa - Armless</b> COM Yardage: 6.50 Freight Class: 250 Product Weight (lbs.): 111 Cubic Feet Per Carton: 55.50			<b>RTA 00</b>											
			<b>OVERALL DIMENSIONS</b>			<b>SEAT DIMENSIONS</b>			<b>BACK DIMENSIONS</b>					
			<b>W</b>	<b>D</b>	<b>H</b>	<b>W</b>	<b>D</b>	<b>H</b>	<b>W</b>	<b>D</b>	<b>H</b>	<b>W</b>	<b>H</b>	
			72	29	28.5	72	19	17	72		12			

DESCRIPTION FEATURES MODEL# STANDARD TEXTILE GRADES



**Ottoman**  
COM Yardage: 1.75  
Freight Class: 150  
Product Weight (lbs.): 50  
Cubic Feet Per Carton: 12.25

MODEL#	STANDARD TEXTILE GRADES											
	1	2	3	4	5	6	7	8	9	10	11	12
<b>3361B</b>	-	1243	1288	1324	1378	1454	1481	1547	1673	1735	1853	2013
<b>3361BLM</b>	-	-	-	-	1405	-	-	1627	-	1806	1972	2172
Leather/Mock Leather												
OVERALL DIMENSIONS			SEAT DIMENSIONS			BACK DIMENSIONS						
W	D	H	W	D	H	W	H					
35.5	20.5	17.5	-	-	-	-	-					

RTA 00

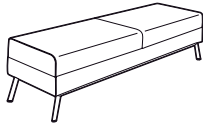

**Bench**  
COM Yardage: 3.50  
Freight Class: 250  
Product Weight (lbs.): 80  
Cubic Feet Per Carton: 33.25

MODEL#	STANDARD TEXTILE GRADES											
	1	2	3	4	5	6	7	8	9	10	11	12
<b>3363B</b>	-	1915	2006	2077	2184	2337	2390	2523	2776	2899	3135	3454
<b>3363BLM</b>	-	-	-	-	2241	-	-	2682	-	3039	3375	3773
Leather/Mock Leather												
OVERALL DIMENSIONS			SEAT DIMENSIONS			BACK DIMENSIONS						
W	D	H	W	D	H	W	H					
72	20.5	17.5	-	-	-	-	-					

RTA 00

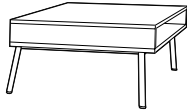

**Side Table - Rectangular**  
COM Yardage: N/A  
Freight Class: 250  
Product Weight (lbs.): 38  
Cubic Feet Per Carton: 11.50

Freestanding.

MODEL#	STANDARD TEXTILE GRADES											
	1	2	3	4	5	6	7	8	9	10	11	12
<b>3878</b>	937	-	-	-	-	-	-	-	-	-	-	-
OVERALL DIMENSIONS			SEAT DIMENSIONS			BACK DIMENSIONS						
W	D	H	W	D	H	W	H					
20	25	16	-	-	-	-	-					

RTA 00

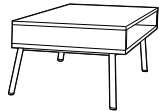

**Side Table - 25" Square**  
COM Yardage: N/A  
Freight Class: 250  
Product Weight (lbs.): 40  
Cubic Feet Per Carton: 11.50

Freestanding.

MODEL#	STANDARD TEXTILE GRADES											
	1	2	3	4	5	6	7	8	9	10	11	12
<b>3879</b>	1021	-	-	-	-	-	-	-	-	-	-	-
OVERALL DIMENSIONS			SEAT DIMENSIONS			BACK DIMENSIONS						
W	D	H	W	D	H	W	H					
25	25	16	-	-	-	-	-					

RTA 00

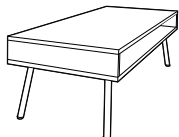



**Coffee Table - 54"**  
COM Yardage: N/A  
Freight Class: 250  
Product Weight (lbs.): 52  
Cubic Feet Per Carton: 16

Freestanding.

MODEL#	STANDARD TEXTILE GRADES											
	1	2	3	4	5	6	7	8	9	10	11	12
<b>3880</b>	1140	-	-	-	-	-	-	-	-	-	-	-
OVERALL DIMENSIONS			SEAT DIMENSIONS			BACK DIMENSIONS						
W	D	H	W	D	H	W	H					
20	54	15	-	-	-	-	-					

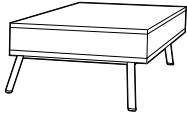
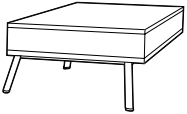
RTA 00

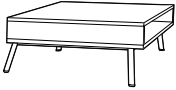
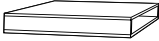
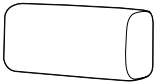
DESCRIPTION	FEATURES	MODEL#	STANDARD TEXTILE GRADES											
			1	2	3	4	5	6	7	8	9	10	11	12
 <p><b>3881R</b></p> <p><b>Bridge Corner Table</b> COM Yardage: - Freight Class: 250 Product Weight (lbs.): 33 Cubic Feet Per Carton: 11.50</p>	 <p><b>3881L</b></p> <p>Require Bracket Kit (3360).</p>	<p><b>3881R</b> 1223</p> <p><b>3881L</b></p>	-	-	-	-	-	-	-	-	-	-	-	
			<p><b>OVERALL DIMENSIONS</b></p> <p>W D H</p>			<p><b>SEAT DIMENSIONS</b></p> <p>W D H</p>			<p><b>BACK DIMENSIONS</b></p> <p>W H</p>					
			25	25	12	-	-	-	-	-	-	-	-	
			<b>RTA 00</b>											
 <p><b>3882</b></p> <p><b>Bridge End Table</b> COM Yardage: N/A Freight Class: 250 Product Weight (lbs.): 32 Cubic Feet Per Carton: 11.50</p>	<p>Require Bracket Kit (3360). To be used with Chair and Sofa models. Not usable with Bench or Ottoman Models</p>	<p><b>3882</b> 667</p>	-	-	-	-	-	-	-	-	-	-		
			<p><b>OVERALL DIMENSIONS</b></p> <p>W D H</p>			<p><b>SEAT DIMENSIONS</b></p> <p>W D H</p>			<p><b>BACK DIMENSIONS</b></p> <p>W H</p>					
			20	25	12	-	-	-	-	-	-	-		
			<b>RTA 00</b>											
 <p><b>3883</b></p> <p><b>Low Side Table</b> COM Yardage: N/A Freight Class: 250 Product Weight (lbs.): 32 Cubic Feet Per Carton: 11.50</p>	<p>Freestanding.</p>	<p><b>3883</b> 927</p>	-	-	-	-	-	-	-	-	-			
			<p><b>OVERALL DIMENSIONS</b></p> <p>W D H</p>			<p><b>SEAT DIMENSIONS</b></p> <p>W D H</p>			<p><b>BACK DIMENSIONS</b></p> <p>W H</p>					
			20	25	12	-	-	-	-	-	-			
			<b>RTA 00</b>											
 <p><b>3884</b></p> <p><b>Bridge Table - 20" Square</b> COM Yardage: N/A Freight Class: 125 Product Weight (lbs.): 23 Cubic Feet Per Carton: 3.40</p>	<p>Require Bracket Kit (3360). To be used with models 3361B and/or 3363B.</p>	<p><b>3884</b> 621</p>	-	-	-	-	-	-	-	-	-			
			<p><b>OVERALL DIMENSIONS</b></p> <p>W D H</p>			<p><b>SEAT DIMENSIONS</b></p> <p>W D H</p>			<p><b>BACK DIMENSIONS</b></p> <p>W H</p>					
			20	20	5	-	-	-	-	-	-			
			<b>RTA 00</b>											
 <p><b>3885</b></p> <p><b>Bolster Cushion</b> COM Yardage: 1 Freight Class: 70 Product Weight (lbs.): 1.50 Cubic Feet Per Carton: 1.30</p>	<p>1 Loose Cushion.</p>	<p><b>3885</b> - 174 194 225 268 286 323 395 430 497 590 703</p>	-	-	-	-	-	-	-	-				
			<p><b>OVERALL DIMENSIONS</b></p> <p>W D H</p>			<p><b>SEAT DIMENSIONS</b></p> <p>W D H</p>			<p><b>BACK DIMENSIONS</b></p> <p>W H</p>					
			16	5	7	-	-	-	-	-	-			
			<b>RTA 00</b>											



# heavy duty/24hr

Concorde Executive 24HR .....	362	G1 Ergo Select TS .....	364	Saxon .....	367
Dexter + Dexter Plus .....	363	Malaga TS .....	359	Truform TS .....	361
Granada TS .....	358	ObusForme Comfort TS .....	360	Vion TS .....	368
Granada Deluxe TS .....	359	Robust .....	366		







model TS3140-3 Malaga



model TS5451-3 Truform

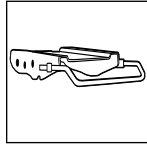

**Multi-Depth Mechanism**  
Standard on all models. Allows seat to move forward and backward over a 2" range with 5 locking positions to provide a more shallow or deeper seat.

**STANDARD FEATURES**

- The **TS** models are available within standard series. **TS** stands for "Three Shift" and each of the TS models are rated for 24-7 applications as well as weight rated up to 350 pounds.
- Multi-tilter models feature a heavy duty mechanism.
- All models are standard with either Ultracell or molded heavy duty seat foam.
- All models have a heavy duty 3" wide back upright.
- All models, except Truform, have outer back panels retained by trim screws for extra security.
- All models, except Truform have standard clear vinyl bumper guards around their outside backs.
- Multi-tilters standard with Pneumatic seat height and sliding seat depth adjustment. Forward and rearward seat tilt with infinite lock and free floating back angle control. Tilt tension control.
- Heavy duty drafting stools are standard with fixed back. Seat depth and pneumatic seat height adjustments. Swivels with adjustable chrome footring.

**OPTIONAL FEATURES**

- An optional ballistic nylon outer back fabric resistant to impact damage is available at an upcharge. Add \$15 (excludes Truform)
- For availability of chair series in Vinyl, please contact a Global Sales Representative.
- **LM** models are available in leather and have additional stitch details. If no **LM** models are listed, series is not available in Leather.
- Grade 2 and above textiles ( or 100,000+ double rubs) are recommended for 24-7 applications.

**DESCRIPTION FEATURES MODEL# STANDARD TEXTILE GRADES**



**LB Heavy Duty Multi-Tilter** Plain Back Ratchet Back  
COM Yardage: 1.50  
Freight Class: 150  
Product Weight (lbs.): 52  
Cubic Feet Per Carton: 9.25

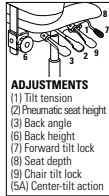

**Granada TS**  
  
Ergonomic Features:  
A, B, C, D, E, F, G, H, M, N, Q, S

	1	2	3	4	5	6	7	8	9	10	11	12
<b>TS3121</b>	1156	1197	1230	1279	1349	1372	1431	1545	1600	1706	1850	2031

OVERALL DIMENSIONS			SEAT DIMENSIONS			BACK DIMENSIONS	
W	D	H	W	D	H	W	H
26	24.5	37.75	20.5	17-19.5	16.5-20.5	19	19-22



**HB Heavy Duty Multi-Tilter** Plain Back Ratchet Back  
COM Yardage: 1.75  
Freight Class: 150  
Product Weight (lbs.): 55  
Cubic Feet Per Carton: 9.25

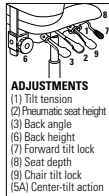

**Granada TS**  
  
Ergonomic Features:  
A, B, C, D, E, F, G, H, M, N, Q, S

	1	2	3	4	5	6	7	8	9	10	11	12
<b>TS3123</b>	1262	1309	1349	1403	1483	1509	1581	1715	1779	1902	2071	2280

OVERALL DIMENSIONS			SEAT DIMENSIONS			BACK DIMENSIONS	
W	D	H	W	D	H	W	H
26	24.5	39.75	20.5	17-19.5	16.5-20.5	19	19-22



**LB Heavy Duty Multi-Tilter** Plain Back  
COM Yardage: 1.50  
Freight Class: 125  
Product Weight (lbs.): 58  
Cubic Feet Per Carton: 9.25

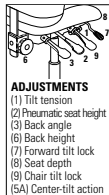









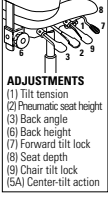

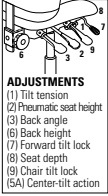

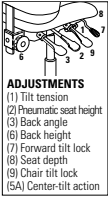

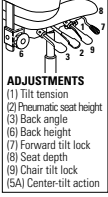

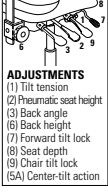

**Granada TS**  
  
Ergonomic Features:  
A, B, C, D, E, F, G, H, M, N, Q, S

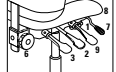

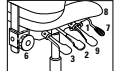

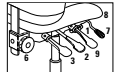

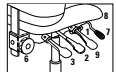

	1	2	3	4	5	6	7	8	9	10	11	12
<b>TS3212</b>	902	943	975	1023	1092	1116	1176	1289	1346	1451	1595	1774

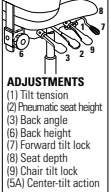
OVERALL DIMENSIONS			SEAT DIMENSIONS			BACK DIMENSIONS	
W	D	H	W	D	H	W	H
26	24	40.	20.5	17-19.5	17.5-21.5	19	21.5-25.5

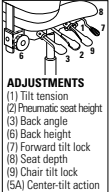

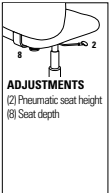
DESCRIPTION	FEATURES	MODEL#	STANDARD TEXTILE GRADES																											
			1	2	3	4	5	6	7	8	9	10	11	12																
 <p><b>HB Heavy Duty Multi-Tilter Plain Back</b> COM Yardage: 1.75 Freight Class: 150 Product Weight (lbs.): 57 Cubic Feet Per Carton: 10.50</p>	 <p><b>ADJUSTMENTS</b> (1) Tilt tension (2) Pneumatic seat height (3) Back angle (6) Back height (7) Forward tilt lock (8) Seat depth (9) Chair tilt lock (5A) Center-tilt action</p>	<p><b>Granada TS</b></p> <p>Ergonomic Features: A, B, C, D, E, F, G, H, M, N, Q, S</p>	<table border="1"> <tr> <td><b>TS3217</b></td> <td>994</td> <td>1043</td> <td>1079</td> <td>1135</td> <td>1215</td> <td>1243</td> <td>1314</td> <td>1448</td> <td>1509</td> <td>1634</td> <td>1804</td> <td>2011</td> </tr> </table>												<b>TS3217</b>	994	1043	1079	1135	1215	1243	1314	1448	1509	1634	1804	2011			
			<b>TS3217</b>	994	1043	1079	1135	1215	1243	1314	1448	1509	1634	1804	2011															
			<p><b>OVERALL DIMENSIONS</b></p> <table border="1"> <tr> <th>W</th> <th>D</th> <th>H</th> </tr> <tr> <td>26</td> <td>24.5</td> <td>43</td> </tr> </table>			W	D	H	26	24.5	43	<p><b>SEAT DIMENSIONS</b></p> <table border="1"> <tr> <th>W</th> <th>D</th> <th>H</th> </tr> <tr> <td>20.5</td> <td>17-19.5</td> <td>17.5-21.5</td> </tr> </table>			W	D	H	20.5	17-19.5	17.5-21.5	<p><b>BACK DIMENSIONS</b></p> <table border="1"> <tr> <th>W</th> <th>H</th> </tr> <tr> <td>19</td> <td>21.5-25.5</td> </tr> </table>						W	H	19	21.5-25.5
			W	D	H																									
26	24.5	43																												
W	D	H																												
20.5	17-19.5	17.5-21.5																												
W	H																													
19	21.5-25.5																													
<p>RTA 2 </p>																														
 <p><b>HB Heavy Duty Multi-Tilter</b> COM Yardage: 2 Freight Class: 125 Product Weight (lbs.): 65 Cubic Feet Per Carton: 9.25</p>	 <p><b>ADJUSTMENTS</b> (1) Tilt tension (2) Pneumatic seat height (3) Back angle (6) Back height (7) Forward tilt lock (8) Seat depth (9) Chair tilt lock (5A) Center-tilt action</p>	<p><b>Granada Deluxe TS</b></p> <p>Ergonomic Features: A, B, C, E, F, H, M, N, Q, S</p>	<table border="1"> <tr> <td><b>TS1170-3</b></td> <td>1018</td> <td>1066</td> <td>1103</td> <td>1158</td> <td>1240</td> <td>1267</td> <td>1337</td> <td>1470</td> <td>1534</td> <td>1659</td> <td>1827</td> <td>2035</td> </tr> </table>												<b>TS1170-3</b>	1018	1066	1103	1158	1240	1267	1337	1470	1534	1659	1827	2035			
			<b>TS1170-3</b>	1018	1066	1103	1158	1240	1267	1337	1470	1534	1659	1827	2035															
			<p><b>OVERALL DIMENSIONS</b></p> <table border="1"> <tr> <th>W</th> <th>D</th> <th>H</th> </tr> <tr> <td>26</td> <td>23.5</td> <td>45</td> </tr> </table>			W	D	H	26	23.5	45	<p><b>SEAT DIMENSIONS</b></p> <table border="1"> <tr> <th>W</th> <th>D</th> <th>H</th> </tr> <tr> <td>21</td> <td>18-20.5</td> <td>17.5-21.5</td> </tr> </table>			W	D	H	21	18-20.5	17.5-21.5	<p><b>BACK DIMENSIONS</b></p> <table border="1"> <tr> <th>W</th> <th>H</th> </tr> <tr> <td>20</td> <td>23-28.25</td> </tr> </table>						W	H	20	23-28.25
			W	D	H																									
26	23.5	45																												
W	D	H																												
21	18-20.5	17.5-21.5																												
W	H																													
20	23-28.25																													
<p>RTA 2 </p>																														
<p>Leather/Mock Leather</p>																														
 <p><b>MB Heavy Duty Multi-Tilter</b> COM Yardage: 1.75 Freight Class: 125 Product Weight (lbs.): 63 Cubic Feet Per Carton: 9.25</p>	 <p><b>ADJUSTMENTS</b> (1) Tilt tension (2) Pneumatic seat height (3) Back angle (6) Back height (7) Forward tilt lock (8) Seat depth (9) Chair tilt lock (5A) Center-tilt action</p>	<p><b>Granada Deluxe TS</b></p> <p>Ergonomic Features: A, B, C, E, F, H, M, N, Q, S</p>	<table border="1"> <tr> <td><b>TS1171-3</b></td> <td>925</td> <td>969</td> <td>999</td> <td>1047</td> <td>1116</td> <td>1140</td> <td>1199</td> <td>1315</td> <td>1369</td> <td>1474</td> <td>1619</td> <td>1798</td> </tr> </table>												<b>TS1171-3</b>	925	969	999	1047	1116	1140	1199	1315	1369	1474	1619	1798			
			<b>TS1171-3</b>	925	969	999	1047	1116	1140	1199	1315	1369	1474	1619	1798															
			<p><b>OVERALL DIMENSIONS</b></p> <table border="1"> <tr> <th>W</th> <th>D</th> <th>H</th> </tr> <tr> <td>26</td> <td>23.5</td> <td>41</td> </tr> </table>			W	D	H	26	23.5	41	<p><b>SEAT DIMENSIONS</b></p> <table border="1"> <tr> <th>W</th> <th>D</th> <th>H</th> </tr> <tr> <td>21</td> <td>18-20.5</td> <td>17.5-21.5</td> </tr> </table>			W	D	H	21	18-20.5	17.5-21.5	<p><b>BACK DIMENSIONS</b></p> <table border="1"> <tr> <th>W</th> <th>H</th> </tr> <tr> <td>20</td> <td>19-24.25</td> </tr> </table>						W	H	20	19-24.25
			W	D	H																									
26	23.5	41																												
W	D	H																												
21	18-20.5	17.5-21.5																												
W	H																													
20	19-24.25																													
<p>RTA 2 </p>																														
<p>Leather/Mock Leather</p>																														
 <p><b>HB Heavy Duty Multi-Tilter</b> COM Yardage: 1.75 Freight Class: 125 Product Weight (lbs.): 63 Cubic Feet Per Carton: 9.25</p>	 <p><b>ADJUSTMENTS</b> (1) Tilt tension (2) Pneumatic seat height (3) Back angle (6) Back height (7) Forward tilt lock (8) Seat depth (9) Chair tilt lock (5A) Center-tilt action</p>	<p><b>Malaga TS</b></p> <p>Ergonomic Features: A, B, C, D, E, F, G, H, M, N, Q, S</p>	<table border="1"> <tr> <td><b>TS3140-3</b></td> <td>1188</td> <td>1234</td> <td>1274</td> <td>1328</td> <td>1409</td> <td>1435</td> <td>1506</td> <td>1641</td> <td>1705</td> <td>1829</td> <td>1997</td> <td>2205</td> </tr> </table>												<b>TS3140-3</b>	1188	1234	1274	1328	1409	1435	1506	1641	1705	1829	1997	2205			
			<b>TS3140-3</b>	1188	1234	1274	1328	1409	1435	1506	1641	1705	1829	1997	2205															
			<p><b>OVERALL DIMENSIONS</b></p> <table border="1"> <tr> <th>W</th> <th>D</th> <th>H</th> </tr> <tr> <td>26</td> <td>25</td> <td>44</td> </tr> </table>			W	D	H	26	25	44	<p><b>SEAT DIMENSIONS</b></p> <table border="1"> <tr> <th>W</th> <th>D</th> <th>H</th> </tr> <tr> <td>20</td> <td>17.5-20</td> <td>16.5-20.5</td> </tr> </table>			W	D	H	20	17.5-20	16.5-20.5	<p><b>BACK DIMENSIONS</b></p> <table border="1"> <tr> <th>W</th> <th>H</th> </tr> <tr> <td>18.5</td> <td>25-27.25</td> </tr> </table>						W	H	18.5	25-27.25
			W	D	H																									
26	25	44																												
W	D	H																												
20	17.5-20	16.5-20.5																												
W	H																													
18.5	25-27.25																													
<p>RTA 2 </p>																														
 <p><b>LB Heavy Duty Multi-Tilter</b> COM Yardage: 60 Freight Class: 125 Product Weight (lbs.): 60 Cubic Feet Per Carton: 9.25</p>	 <p><b>ADJUSTMENTS</b> (1) Tilt tension (2) Pneumatic seat height (3) Back angle (6) Back height (7) Forward tilt lock (8) Seat depth (9) Chair tilt lock (5A) Center-tilt action</p>	<p><b>Malaga TS</b></p> <p>Ergonomic Features: A, B, C, D, E, F, G, H, M, N, Q, S</p>	<table border="1"> <tr> <td><b>TS3141-3</b></td> <td>1095</td> <td>1135</td> <td>1167</td> <td>1215</td> <td>1284</td> <td>1308</td> <td>1369</td> <td>1482</td> <td>1537</td> <td>1643</td> <td>1788</td> <td>1969</td> </tr> </table>												<b>TS3141-3</b>	1095	1135	1167	1215	1284	1308	1369	1482	1537	1643	1788	1969			
			<b>TS3141-3</b>	1095	1135	1167	1215	1284	1308	1369	1482	1537	1643	1788	1969															
			<p><b>OVERALL DIMENSIONS</b></p> <table border="1"> <tr> <th>W</th> <th>D</th> <th>H</th> </tr> <tr> <td>25</td> <td>24.5</td> <td>39.75</td> </tr> </table>			W	D	H	25	24.5	39.75	<p><b>SEAT DIMENSIONS</b></p> <table border="1"> <tr> <th>W</th> <th>D</th> <th>H</th> </tr> <tr> <td>20</td> <td>17.5-20</td> <td>16.5-20.5</td> </tr> </table>			W	D	H	20	17.5-20	16.5-20.5	<p><b>BACK DIMENSIONS</b></p> <table border="1"> <tr> <th>W</th> <th>H</th> </tr> <tr> <td>18.5</td> <td>20.5-22.75</td> </tr> </table>						W	H	18.5	20.5-22.75
			W	D	H																									
25	24.5	39.75																												
W	D	H																												
20	17.5-20	16.5-20.5																												
W	H																													
18.5	20.5-22.75																													
<p>RTA 1 </p>																														

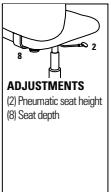
DESCRIPTION	FEATURES	MODEL#	STANDARD TEXTILE GRADES																											
			1	2	3	4	5	6	7	8	9	10	11	12																
 <p><b>HB Heavy Duty Multi -Tilter</b> COM Yardage: 2.25 Freight Class: 125 Product Weight (lbs.): 74 Cubic Feet Per Carton: 11</p>	 <p><b>ADJUSTMENTS</b> (1) Tilt tension (2) Pneumatic seat height (3) Back angle (6) Back height (7) Forward tilt lock (8) Seat depth (9) Chair tilt lock (5A) Center-tilt action</p>	<p><b>ObusForme Comfort TS</b></p> <p>Ergonomic Features: A, C, E, F, H, M, N, S</p>	<table border="1"> <tr> <td><b>TS1240-3</b></td> <td>1087</td> <td>1151</td> <td>1199</td> <td>1276</td> <td>1381</td> <td>1431</td> <td>1527</td> <td>1681</td> <td>1799</td> <td>1932</td> <td>2202</td> <td>2490</td> </tr> </table>												<b>TS1240-3</b>	1087	1151	1199	1276	1381	1431	1527	1681	1799	1932	2202	2490			
			<b>TS1240-3</b>	1087	1151	1199	1276	1381	1431	1527	1681	1799	1932	2202	2490															
			<p><b>OVERALL DIMENSIONS</b></p> <table border="1"> <tr> <th>W</th> <th>D</th> <th>H</th> </tr> <tr> <td>26</td> <td>25</td> <td>48</td> </tr> </table>			W	D	H	26	25	48	<p><b>SEAT DIMENSIONS</b></p> <table border="1"> <tr> <th>W</th> <th>D</th> <th>H</th> </tr> <tr> <td>21</td> <td>17.5-20</td> <td>16-20</td> </tr> </table>			W	D	H	21	17.5-20	16-20	<p><b>BACK DIMENSIONS</b></p> <table border="1"> <tr> <th>W</th> <th>H</th> </tr> <tr> <td>19</td> <td>27</td> </tr> </table>						W	H	19	27
			W	D	H																									
26	25	48																												
W	D	H																												
21	17.5-20	16-20																												
W	H																													
19	27																													
<p>RTA 2 </p>																														
 <p><b>MB Heavy Duty Multi -Tilter</b> COM Yardage: 2 Freight Class: 125 Product Weight (lbs.): 71 Cubic Feet Per Carton: 10.50</p>	 <p><b>ADJUSTMENTS</b> (1) Tilt tension (2) Pneumatic seat height (3) Back angle (6) Back height (7) Forward tilt lock (8) Seat depth (9) Chair tilt lock (5A) Center-tilt action</p>	<p><b>ObusForme Comfort TS</b></p> <p>Ergonomic Features: A, C, E, F, H, M, N, S</p>	<table border="1"> <tr> <td><b>TS1241-3</b></td> <td>1038</td> <td>1096</td> <td>1142</td> <td>1211</td> <td>1309</td> <td>1344</td> <td>1429</td> <td>1592</td> <td>1670</td> <td>1823</td> <td>2028</td> <td>2284</td> </tr> </table>												<b>TS1241-3</b>	1038	1096	1142	1211	1309	1344	1429	1592	1670	1823	2028	2284			
			<b>TS1241-3</b>	1038	1096	1142	1211	1309	1344	1429	1592	1670	1823	2028	2284															
			<p><b>OVERALL DIMENSIONS</b></p> <table border="1"> <tr> <th>W</th> <th>D</th> <th>H</th> </tr> <tr> <td>26</td> <td>25</td> <td>44</td> </tr> </table>			W	D	H	26	25	44	<p><b>SEAT DIMENSIONS</b></p> <table border="1"> <tr> <th>W</th> <th>D</th> <th>H</th> </tr> <tr> <td>21</td> <td>17.5-20</td> <td>16-20</td> </tr> </table>			W	D	H	21	17.5-20	16-20	<p><b>BACK DIMENSIONS</b></p> <table border="1"> <tr> <th>W</th> <th>H</th> </tr> <tr> <td>19.5</td> <td>22-27.25</td> </tr> </table>						W	H	19.5	22-27.25
			W	D	H																									
26	25	44																												
W	D	H																												
21	17.5-20	16-20																												
W	H																													
19.5	22-27.25																													
<p>RTA 2 </p>																														
 <p><b>HB Heavy Duty Multi -Tilter with Schukra</b> COM Yardage: 2.25 Freight Class: 125 Product Weight (lbs.): 74 Cubic Feet Per Carton: 11</p>	 <p><b>ADJUSTMENTS</b> (1) Tilt tension (2) Pneumatic seat height (3) Back angle (6) Back height (7) Forward tilt lock (8) Seat depth (9) Chair tilt lock (5A) Center-tilt action</p>	<p><b>ObusForme Comfort TS</b></p> <p>Ergonomic Features: A, C, E, F, H, M, N, S</p>	<table border="1"> <tr> <td><b>TS1260-3</b></td> <td>1204</td> <td>1268</td> <td>1320</td> <td>1397</td> <td>1507</td> <td>1547</td> <td>1643</td> <td>1827</td> <td>1915</td> <td>2085</td> <td>2317</td> <td>2605</td> </tr> </table>												<b>TS1260-3</b>	1204	1268	1320	1397	1507	1547	1643	1827	1915	2085	2317	2605			
			<b>TS1260-3</b>	1204	1268	1320	1397	1507	1547	1643	1827	1915	2085	2317	2605															
			<p><b>OVERALL DIMENSIONS</b></p> <table border="1"> <tr> <th>W</th> <th>D</th> <th>H</th> </tr> <tr> <td>26</td> <td>25</td> <td>48</td> </tr> </table>			W	D	H	26	25	48	<p><b>SEAT DIMENSIONS</b></p> <table border="1"> <tr> <th>W</th> <th>D</th> <th>H</th> </tr> <tr> <td>21</td> <td>17.5-20</td> <td>16-20</td> </tr> </table>			W	D	H	21	17.5-20	16-20	<p><b>BACK DIMENSIONS</b></p> <table border="1"> <tr> <th>W</th> <th>H</th> </tr> <tr> <td>19.5</td> <td>27-32.25</td> </tr> </table>						W	H	19.5	27-32.25
			W	D	H																									
26	25	48																												
W	D	H																												
21	17.5-20	16-20																												
W	H																													
19.5	27-32.25																													
<p>RTA 2 </p>																														
 <p><b>MB Heavy Duty Multi -Tilter with Schukra</b> COM Yardage: 2 Freight Class: 125 Product Weight (lbs.): 69 Cubic Feet Per Carton: 10.50</p>	 <p><b>ADJUSTMENTS</b> (1) Tilt tension (2) Pneumatic seat height (3) Back angle (6) Back height (7) Forward tilt lock (8) Seat depth (9) Chair tilt lock (5A) Center-tilt action</p>	<p><b>ObusForme Comfort TS</b></p> <p>Ergonomic Features: A, C, E, F, H, M, N, S</p>	<table border="1"> <tr> <td><b>TS1261-3</b></td> <td>1158</td> <td>1216</td> <td>1262</td> <td>1331</td> <td>1429</td> <td>1464</td> <td>1550</td> <td>1712</td> <td>1791</td> <td>1942</td> <td>2147</td> <td>2405</td> </tr> </table>												<b>TS1261-3</b>	1158	1216	1262	1331	1429	1464	1550	1712	1791	1942	2147	2405			
			<b>TS1261-3</b>	1158	1216	1262	1331	1429	1464	1550	1712	1791	1942	2147	2405															
			<p><b>OVERALL DIMENSIONS</b></p> <table border="1"> <tr> <th>W</th> <th>D</th> <th>H</th> </tr> <tr> <td>26</td> <td>25</td> <td>44</td> </tr> </table>			W	D	H	26	25	44	<p><b>SEAT DIMENSIONS</b></p> <table border="1"> <tr> <th>W</th> <th>D</th> <th>H</th> </tr> <tr> <td>21</td> <td>17.5-20</td> <td>16-20</td> </tr> </table>			W	D	H	21	17.5-20	16-20	<p><b>BACK DIMENSIONS</b></p> <table border="1"> <tr> <th>W</th> <th>H</th> </tr> <tr> <td>19.5</td> <td>22</td> </tr> </table>						W	H	19.5	22
			W	D	H																									
26	25	44																												
W	D	H																												
21	17.5-20	16-20																												
W	H																													
19.5	22																													
<p>RTA 2 </p>																														

DESCRIPTION	FEATURES	MODEL#	STANDARD TEXTILE GRADES																																
			1	2	3	4	5	6	7	8	9	10	11	12																					
 <p><b>HB Heavy Duty Multi - Tilter</b> COM Yardage: 2 Freight Class: 125 Product Weight (lbs.): 63 Cubic Feet Per Carton: 10.50</p>	 <p><b>ADJUSTMENTS</b> (1) Tilt tension (2) Pneumatic seat height (3) Back angle (6) Back height (7) Forward tilt lock (8) Seat depth (9) Chair tilt lock (5A) Center-tilt action</p>	<p><b>Truform TS</b></p> <p>Ergonomic Features: A, B, C, D, F, G, H, M, N, Q, S</p>	<table border="1"> <tr> <td><b>TS5450-3</b></td> <td>832</td> <td>885</td> <td>925</td> <td>988</td> <td>1078</td> <td>1110</td> <td>1187</td> <td>1334</td> <td>1406</td> <td>1543</td> <td>1729</td> <td>1963</td> </tr> </table>												<b>TS5450-3</b>	832	885	925	988	1078	1110	1187	1334	1406	1543	1729	1963								
			<b>TS5450-3</b>	832	885	925	988	1078	1110	1187	1334	1406	1543	1729	1963																				
			<table border="1"> <tr> <th colspan="3">OVERALL DIMENSIONS</th> <th colspan="3">SEAT DIMENSIONS</th> <th colspan="2">BACK DIMENSIONS</th> </tr> <tr> <th>W</th> <th>D</th> <th>H</th> <th>W</th> <th>D</th> <th>H</th> <th>W</th> <th>H</th> </tr> <tr> <td>26</td> <td>25</td> <td>42</td> <td>20</td> <td>18-20.5</td> <td>16.5-20.5</td> <td>20</td> <td>23.5-26</td> </tr> </table>			OVERALL DIMENSIONS			SEAT DIMENSIONS			BACK DIMENSIONS		W	D	H	W	D	H	W	H	26	25	42	20	18-20.5	16.5-20.5	20	23.5-26	<p><b>RTA 2</b></p>					
			OVERALL DIMENSIONS			SEAT DIMENSIONS			BACK DIMENSIONS																										
W	D	H	W	D	H	W	H																												
26	25	42	20	18-20.5	16.5-20.5	20	23.5-26																												
 <p><b>MB Heavy Duty Multi - Tilter</b> COM Yardage: 1.75 Freight Class: 150 Product Weight (lbs.): 60 Cubic Feet Per Carton: 10.50</p>	 <p><b>ADJUSTMENTS</b> (1) Tilt tension (2) Pneumatic seat height (3) Back angle (6) Back height (7) Forward tilt lock (8) Seat depth (9) Chair tilt lock (5A) Center-tilt action</p>	<p><b>Truform TS</b></p> <p>Ergonomic Features: A, B, C, D, F, G, H, M, N, Q, S</p>	<table border="1"> <tr> <td><b>TS5451-3</b></td> <td>803</td> <td>850</td> <td>887</td> <td>942</td> <td>1019</td> <td>1047</td> <td>1115</td> <td>1245</td> <td>1307</td> <td>1427</td> <td>1590</td> <td>1793</td> </tr> </table>												<b>TS5451-3</b>	803	850	887	942	1019	1047	1115	1245	1307	1427	1590	1793								
			<b>TS5451-3</b>	803	850	887	942	1019	1047	1115	1245	1307	1427	1590	1793																				
			<table border="1"> <tr> <th colspan="3">OVERALL DIMENSIONS</th> <th colspan="3">SEAT DIMENSIONS</th> <th colspan="2">BACK DIMENSIONS</th> </tr> <tr> <th>W</th> <th>D</th> <th>H</th> <th>W</th> <th>D</th> <th>H</th> <th>W</th> <th>H</th> </tr> <tr> <td>26</td> <td>25</td> <td>38.5</td> <td>20</td> <td>18-20.5</td> <td>16.5-20.5</td> <td>20</td> <td>20-22.5</td> </tr> </table>			OVERALL DIMENSIONS			SEAT DIMENSIONS			BACK DIMENSIONS		W	D	H	W	D	H	W	H	26	25	38.5	20	18-20.5	16.5-20.5	20	20-22.5	<p><b>RTA 2</b></p>					
			OVERALL DIMENSIONS			SEAT DIMENSIONS			BACK DIMENSIONS																										
W	D	H	W	D	H	W	H																												
26	25	38.5	20	18-20.5	16.5-20.5	20	20-22.5																												
 <p><b>MB Heavy Duty Drafting Stool Armless</b> COM Yardage: 1.75 Freight Class: 250 Product Weight (lbs.): 35 Cubic Feet Per Carton: 10.75</p>	 <p><b>ADJUSTMENTS</b> (2) Pneumatic seat height (8) Seat depth</p>	<p><b>Truform S</b></p> <p>Ergonomic Features: A, B, C, J, M, N</p>	<table border="1"> <tr> <td><b>S5457-6</b></td> <td>851</td> <td>899</td> <td>935</td> <td>988</td> <td>1068</td> <td>1094</td> <td>1161</td> <td>1291</td> <td>1354</td> <td>1474</td> <td>1637</td> <td>1841</td> </tr> </table>												<b>S5457-6</b>	851	899	935	988	1068	1094	1161	1291	1354	1474	1637	1841								
			<b>S5457-6</b>	851	899	935	988	1068	1094	1161	1291	1354	1474	1637	1841																				
			<table border="1"> <tr> <th colspan="3">OVERALL DIMENSIONS</th> <th colspan="3">SEAT DIMENSIONS</th> <th colspan="2">BACK DIMENSIONS</th> </tr> <tr> <th>W</th> <th>D</th> <th>H</th> <th>W</th> <th>D</th> <th>H</th> <th>W</th> <th>H</th> </tr> <tr> <td>20</td> <td>25</td> <td>43</td> <td>20</td> <td>17.5-19</td> <td>22-30</td> <td>20</td> <td>20</td> </tr> </table>			OVERALL DIMENSIONS			SEAT DIMENSIONS			BACK DIMENSIONS		W	D	H	W	D	H	W	H	20	25	43	20	17.5-19	22-30	20	20	<p><b>RTA 2</b></p>					
			OVERALL DIMENSIONS			SEAT DIMENSIONS			BACK DIMENSIONS																										
W	D	H	W	D	H	W	H																												
20	25	43	20	17.5-19	22-30	20	20																												
 <p><b>MB Heavy Duty Drafting Stool</b> COM Yardage: 1.75 Freight Class: 150 Product Weight (lbs.): 45 Cubic Feet Per Carton: 10.75</p>	 <p><b>ADJUSTMENTS</b> (2) Pneumatic seat height (8) Seat depth</p>	<p><b>Truform S</b></p> <p>Ergonomic Features: A, B, C, J, M, N</p>	<table border="1"> <tr> <td><b>S5458-6</b></td> <td>987</td> <td>1034</td> <td>1071</td> <td>1125</td> <td>1204</td> <td>1230</td> <td>1299</td> <td>1428</td> <td>1489</td> <td>1610</td> <td>1773</td> <td>1976</td> </tr> </table>												<b>S5458-6</b>	987	1034	1071	1125	1204	1230	1299	1428	1489	1610	1773	1976								
			<b>S5458-6</b>	987	1034	1071	1125	1204	1230	1299	1428	1489	1610	1773	1976																				
			<table border="1"> <tr> <th colspan="3">OVERALL DIMENSIONS</th> <th colspan="3">SEAT DIMENSIONS</th> <th colspan="2">BACK DIMENSIONS</th> </tr> <tr> <th>W</th> <th>D</th> <th>H</th> <th>W</th> <th>D</th> <th>H</th> <th>W</th> <th>H</th> </tr> <tr> <td>26</td> <td>25</td> <td>43</td> <td>20</td> <td>17.5-19</td> <td>22-30</td> <td>20</td> <td>20</td> </tr> </table>			OVERALL DIMENSIONS			SEAT DIMENSIONS			BACK DIMENSIONS		W	D	H	W	D	H	W	H	26	25	43	20	17.5-19	22-30	20	20	<p><b>RTA 2</b></p>					
			OVERALL DIMENSIONS			SEAT DIMENSIONS			BACK DIMENSIONS																										
W	D	H	W	D	H	W	H																												
26	25	43	20	17.5-19	22-30	20	20																												

CONCORDE™ EXECUTIVE 24HR



model 2424



**Push Button**  
Location within reach increases your adjustment. Promotes good posture as you move to various positions.

STANDARD FEATURES

- All adjustments are made with button controls that are conveniently located in full view, for easy use.
- Compound curved molded foam seat and back cushions.
- Seat cushion with Velcro attachment is easily removed and replaced.
- Rated for Multi-Shift use for persons up to 350 pounds.
- Standard with Allen-bolted width adjustable arms (Allen key included). Arms adjust 1 1/4" wider on each side, a total of 2 1/2" extra width.

- Pneumatic seat height adjustment and 5 - position tilt lock. Tilt tension control.
- Ratchet style back height adjustment.
- All models are standard with a reinforced five-legged, injection molded base with **C10** casters, Black (**BK**) Only.

OPTIONAL FEATURES

- Concorde Executive is available in the following GLOBAL textiles: Crescent, Imprint, Renewal, Replay, Silhouette (Grade 2) and Prescott Leather (Grade 10).
- Models are Not available with **C7** glides.

DESCRIPTION	FEATURES	MODEL#	STANDARD TEXTILE GRADES											
-------------	----------	--------	-------------------------	--	--	--	--	--	--	--	--	--	--	--



**HB Synchro - Tilter** Concorde Executive 24HR  
COM Yardage: 2.50  
Freight Class: 250  
Product Weight (lbs.): 78  
Cubic Feet Per Carton: 23.50

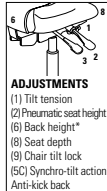

**ADJUSTMENTS**  
(1) Tilt tension  
(2) Pneumatic seat height  
(6) Back height\*  
(8) Seat depth  
(9) Chair tilt lock  
(5C) Synchro-tilt action  
Anti-kick back

Seat depth Adjust: 16" to 18"

Ergonomic Features:  
A, B, C, D, E, L, M, N, Q, T

	1	2	3	4	5	6	7	8	9	10	11	12
<b>2424</b>	-	2354	2407	2485	2599	2641	2737	2923	3013	3184	3421	3716

OVERALL DIMENSIONS			SEAT DIMENSIONS			BACK DIMENSIONS		
W	D	H	W	D	H	W	H	

28.5 27 50 21 17.5-19 18-22 21 28-31

RTA 00



**HB Synchro - Tilter** Concorde Executive 24HR  
COM Yardage: 2.50  
Freight Class: 250  
Product Weight (lbs.): 78  
Cubic Feet Per Carton: 23.50

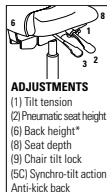

**ADJUSTMENTS**  
(1) Tilt tension  
(2) Pneumatic seat height  
(6) Back height\*  
(8) Seat depth  
(9) Chair tilt lock  
(5C) Synchro-tilt action  
Anti-kick back

Additional seat depth: 1"

Ergonomic Features:  
A, B, C, D, E, L, M, N, Q, T

	1	2	3	4	5	6	7	8	9	10	11	12
<b>2424-18</b>	-	2392	2448	2526	2635	2680	2778	2962	3054	3226	3464	3758

OVERALL DIMENSIONS			SEAT DIMENSIONS			BACK DIMENSIONS		
W	D	H	W	D	H	W	H	

28.5 27 50 21 17.5-19 18-22 21 28-31

RTA 00

## DEXTER™ & DEXTER PLUS™



model 2432-16 (TD)

model 2436-1 (3R)

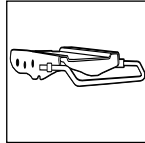

**Multi-Depth Mechanism**  
Standard on all models. Allows seat to move forward and backward over a 2" range with 5 locking positions to provide a more shallow or deeper seat.







**Impact Resistant Back Cover**  
Impact resistant back shroud offers increased durability. Black Only.

## STANDARD FEATURES

- Compound curved molded memory foam seat cushion distributes body weight evenly for better circulation and a fluid-like fit.
- Dexter and Dexter Plus models are standard with concave-shaped, height adjustable urethane arms (**3R**).
- Removable seat cushion requires no tools (Dexter Plus models Only).
- Back height and pneumatic seat height adjustments. Tilt tension control.
- Synchronized seat and back movement with 2-to-1 ratio can be locked in 5 different positions.
- Base and frame available in Black (**BK**) Only.
- Rated for Multi-Shift use for people up to 350 pounds.
- All models are standard with a heavy-duty frame and a five-legged, injection molded base.
- **C10** casters are standard.

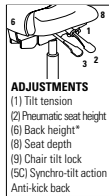
## OPTIONAL FEATURES

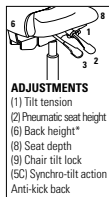
- Optional adjustable height T-arms with teardrop shaped urethane armcaps (**TD**) are available. No Charge.
- Vari-Width Adapter Plate (**WA**) is standard on Models 2436-1 and 2437-1 when chairs are ordered with adjustable height arms (**TD** or **3M**). Allows each arm to move outward an additional 2" (for a total of 4" extra seat width) and locks with the use of an easy to maneuver lever.
- Please see page 309 for additional caster options. Optional casters may be priced higher than the standard casters for your chair and the difference will be charged. Lower priced optional casters will not be credited.
- Available in fabrics with the EXCEPTION of Leather, Jenny, Match, Quilt and Allante FRee.

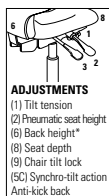
DESCRIPTION	FEATURES	MODEL#	STANDARD TEXTILE GRADES											
			1	2	3	4	5	6	7	8	9	10	11	12
 <p><b>HB Synchro - Tilter</b> Dexter Plus COM Yardage: 1.75 Freight Class: 150 Product Weight (lbs.): 64 Cubic Feet Per Carton: 13</p>	 <p><b>ADJUSTMENTS</b> (1) Tilt tension (2) Pneumatic seat height (6) Back height* (8) Seat depth (9) Chair tilt lock (5C) Synchro-tilt action Anti-kick back</p>	<p><b>2432-16</b></p>	-	1789	1825	1878	1954	1982	2049	2175	2237	2354	2516	2715
			<b>OVERALL DIMENSIONS</b>			<b>SEAT DIMENSIONS</b>			<b>BACK DIMENSIONS</b>					
			<b>W</b>	<b>D</b>	<b>H</b>	<b>W</b>	<b>D</b>	<b>H</b>	<b>W</b>	<b>H</b>				
	26	25	43.5	20.5	18-20	18-22	19	22-24.5						
				<b>RTA 2</b>										
 <p><b>MB Synchro - Tilter</b> Dexter Plus COM Yardage: 1.50 Freight Class: 150 Product Weight (lbs.): 64 Cubic Feet Per Carton: 13</p>	 <p><b>ADJUSTMENTS</b> (1) Tilt tension (2) Pneumatic seat height (6) Back height* (8) Seat depth (9) Chair tilt lock (5C) Synchro-tilt action Anti-kick back</p>	<p><b>2433-16</b></p>	-	1713	1744	1793	1860	1885	1944	2053	2110	2212	2355	2529
			<b>OVERALL DIMENSIONS</b>			<b>SEAT DIMENSIONS</b>			<b>BACK DIMENSIONS</b>					
			<b>W</b>	<b>D</b>	<b>H</b>	<b>W</b>	<b>D</b>	<b>H</b>	<b>W</b>	<b>H</b>				
	26	24	41	19	17-19	18-22	17.5	20-22.5						
				<b>RTA 2</b>										
 <p><b>HB Synchro - Tilter</b> Dexter COM Yardage: 1.25 Freight Class: 150 Product Weight (lbs.): 54 Cubic Feet Per Carton: 13</p>	 <p><b>ADJUSTMENTS</b> (1) Tilt tension (2) Pneumatic seat height (6) Back height* (8) Seat depth (9) Chair tilt lock (5C) Synchro-tilt action Anti-kick back</p>	<p><b>2436-1</b></p>	1483	1517	1543	1581	1543	1659	1707	1800	1844	1932	2050	2196
			<b>OVERALL DIMENSIONS</b>			<b>SEAT DIMENSIONS</b>			<b>BACK DIMENSIONS</b>					
			<b>W</b>	<b>D</b>	<b>H</b>	<b>W</b>	<b>D</b>	<b>H</b>	<b>W</b>	<b>H</b>				
	26	24	43.5	20	17-19	17.5-21.5	19	23.5-26						
				<b>RTA 2</b>										

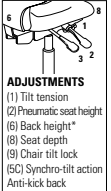
DESCRIPTION	FEATURES	MODEL#	STANDARD TEXTILE GRADES																					
			1	2	3	4	5	6	7	8	9	10	11	12										
 <p><b>MB Synchro - Tilter</b> Dexter COM Yardage: 1 Freight Class: 250 Product Weight (lbs.): 50 Cubic Feet Per Carton: 13</p>	 <p><b>ADJUSTMENTS</b> (1) Tilt tension (2) Pneumatic seat height (6) Back height* (8) Seat depth (9) Chair tilt lock (5C) Synchro-tilt action Anti-kick back</p>	2437-1	1407	1433	1455	1486	1532	1550	1587	1662	1697	1768	1861	1978										
		<p><b>OVERALL DIMENSIONS</b></p> <table border="1"> <thead> <tr> <th>W</th> <th>D</th> <th>H</th> </tr> </thead> <tbody> <tr> <td>26</td> <td>24</td> <td>41</td> </tr> </tbody> </table>			W	D	H	26	24	41	<p><b>SEAT DIMENSIONS</b></p> <table border="1"> <thead> <tr> <th>W</th> <th>D</th> <th>H</th> </tr> </thead> <tbody> <tr> <td>19</td> <td>17-19</td> <td>17.5-21.5</td> </tr> </tbody> </table>			W	D	H	19	17-19	17.5-21.5	<p><b>BACK DIMENSIONS</b></p> <table border="1"> <thead> <tr> <th>W</th> <th>H</th> </tr> </thead> <tbody> <tr> <td>17.5</td> <td>20-22.5</td> </tr> </tbody> </table>			W	H
W	D	H																						
26	24	41																						
W	D	H																						
19	17-19	17.5-21.5																						
W	H																							
17.5	20-22.5																							

Ergonomic Features:  
A, B, C, D, E, L, M, N, Q, T



**G1 ERGO SELECT™ TS**



model TS7333

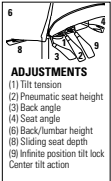

Ergonomic Features:  
A, B, C, D, E, F, G, H, M, N,  
Q, R, S, U

**MECHANISM:**  
Multi-tilter mechanism (-3)

**STANDARD FEATURES**

- TS models are available within the standard G1 Ergo Select series. TS stands for “three shift” and each TS model is rated for 24/7 applications as well as weight rated up to 350 lbs.
- Models feature a heavy duty multi-tilter mechanism, cylinder and molded heavy duty seat foam.
- Standard with pneumatic seat height, forward and rearward seat tilt with infinite lock, free floating back angle control, tilt tension control and side activated sliding seat depth.
- Available in three back heights and two seat sizes (standard or generous).
- Stitch detail on edges of seat and back is discrete, using matched thread as standard.
- Standard with height and width adjustable (G5) arms with sliding armcaps. Armcaps also articulate inwards and outwards to aim toward the keyboard or mouse area.
- Five prong, injection molded, fiberglass reinforced nylon Black base with (C82) dual wheel carpet casters.
- G1 Ergo Select is fully compliant with latest BIFMA G1, GSA, and CGSB specifications.
- For 24 hour applications, Global’s Lifetime Warranty is applicable only on fabrics that are rated for 100,000 double rubs.
- Upholstery options: fabric, vinyl or leather. Leather/mock leather combination not available.

**OPTIONAL FEATURES**

- Upholstery is available with exaggerated top stitch detail (heavier thread). Fourteen coordinating or contrasting colors may be selected. Please specify.

- Optional Ergo Select arms are height (4”) and width adjustable with sliding armcaps. Armcaps also articulate inwards (25°) and outwards (25°) to aim toward the keyboard or mouse area.

Please add option codes in the following order:



- **Model number**  
TS7331 Medium back  
TS7332 High back  
TS7333 Extended high back
- **Textile**  
Specify textile codes for back and seat
- **Mechanism**  
(-3) Multi-tilter mechanism
- **Seat Size**  
(STAN) Standard seat  
(GS) Generous seat
- **Arms**  
(G5) G5 arms.....**Standard**  
(H1) Ergo Select arms.....**Add \$65**  
(H2) Ergo Select arms w/wide armcaps.....**Add \$89**
- **Base**  
(B7) Black nylon B7B base .....**Standard**  
(A7) Polished aluminum B7A base.....**Add \$121**
- **Casters**  
(C82) Dual wheel carpet casters.....**Standard**  
(C82R) Dual wheel hard floor casters.....**Add \$68**
- **Stitch detail**  
(MS) Color matched stitching.  
Decorative top stitch.....**No upcharge**  
(XP) Black (XB) Beige  
(XG) Copen (XA) Graphite  
(XK) Mahogany (XJ) Natural  
(XH) Navy #3 (XD) New Grey  
(XF) Nickel (XN) Off-White  
(XL) Rubytone (XI) Scarlett  
(XC) Smoke (XE) Taupe  
(colors shown on website)

**EXAMPLE G1 ERGO SELECT TS ORDER CODE:**

TS7332	-WA53	-WA53	-3	-STAN	-H1	-B7	-C82	-MS
Model #	Back fabric	Seat fabric	Mechanism	Seat size	Arms	Base	Casters	Stitch detail

G1 Ergo Select TS dimensional information: based on measurements with heavy duty multi-tilter mechanism				
	Distance between arms	Standard arm height	Seat depth range	Standard seat height
<b>Standard seat (STAN)</b> Heavy duty 4” lift & (H1) arms	16.0” - 21.5” = 5.5” adjustment	7.3” - 11.4”	16.5” - 18.75”	17.5” - 21.5”
<b>Generous seat (GS)</b> Heavy duty 4” lift & (H1) arms	17.25” - 22.75” = 5.5” adjustment		17.25” - 19.5”	



DESCRIPTION	FEATURES	MODEL#	STANDARD TEXTILE GRADES											
			1	2	3	4	5	6	7	8	9	10	11	12
 <p><b>Medium Back</b></p> <p>COM Yardage: 1.65                      Freight Class: 125                      Product Weight (lbs.): 66                      Cubic Feet Per Carton: 10.50</p>	See series notes for mechanism options.	<b>TS7331</b>	1056	1100	1132	1183	1254	1287	1352	1454	1533	1622	1802	1996
		<b>OVERALL DIMENSIONS</b>			<b>SEAT DIMENSIONS</b>			<b>BACK DIMENSIONS</b>						
		<b>W</b>	<b>D</b>	<b>H</b>	<b>W</b>	<b>D</b>	<b>H</b>	<b>W</b>	<b>H</b>					
		24	21.5	42	19.75	15.5-18.5	17.5-21.5	19	22					
					<b>RTA 1</b>			1 per carton						
 <p><b>High Back</b></p> <p>COM Yardage: 1.75                      Freight Class: 125                      Product Weight (lbs.): 68                      Cubic Feet Per Carton: 10.50</p>	See series notes for mechanism options.	<b>TS7332</b>	1108	1154	1189	1243	1319	1355	1423	1533	1618	1711	1905	2111
		<b>OVERALL DIMENSIONS</b>			<b>SEAT DIMENSIONS</b>			<b>BACK DIMENSIONS</b>						
		<b>W</b>	<b>D</b>	<b>H</b>	<b>W</b>	<b>D</b>	<b>H</b>	<b>W</b>	<b>H</b>					
		24.5	23	45.5	16.5-18.75	15.5-18.5	17.5-21.5	19	24.5					
					<b>RTA 1</b>			1 per carton						
 <p><b>Extended High Back</b></p> <p>COM Yardage: 2                      Freight Class: 125                      Product Weight (lbs.): 70                      Cubic Feet Per Carton: 11</p>	See series notes for mechanism options.	<b>TS7333</b>	1159	1212	1253	1315	1401	1442	1522	1647	1745	1852	2075	2313
		<b>OVERALL DIMENSIONS</b>			<b>SEAT DIMENSIONS</b>			<b>BACK DIMENSIONS</b>						
		<b>W</b>	<b>D</b>	<b>H</b>	<b>W</b>	<b>D</b>	<b>H</b>	<b>W</b>	<b>H</b>					
		26	24	51	16.5-18.75	15.5-18.5	17.5-21.5	19	27					
					<b>RTA 1</b>			1 per carton						



ROBUST



model 2527



**Memory Foam**  
Available, use code "MF".  
Add \$84.

STANDARD FEATURES

- Heavy duty chair rated for multi shift users up to 500 pounds.
- Standard with a six prong, oval tubular steel base (32" in diameter) in Black (BK) Only.
- Standard with a solid steel loop style arm. The arm is vinyl dipped to be warm to the touch and impact absorbent.
- Arms are width adjustable for an extra 2" on each side, providing additional room and comfort for users.
- There are no arm options for this series.
- Side tension adjustment can be reached from a seated position.
- Standard with Ultracell high density, high resilient foam on seat and back.
- Large diameter 3" black casters, providing easier mobility.
- Casters are suitable for hard surface flooring or carpet. There are no caster options for this series.
- Standard pneumatic seat height adjustment. Forward and rearward seat tilt with infinite lock and free floating back angle control. Tilt tension control.

- This series has a two-tone fabric combination as standard. Trim is always Silhouette fabric, SL20 Asphalt.

OPTIONAL FEATURES

- Memory Foam seats are optionally available. This slow release foam molds to your contour and evenly distributes body weight. Please specify (MF) Add \$84.
- When upholstered in Vinyl or Leather please note that the Black trim will always be Mock Leather 550 Black.
- There is no option for all leather. Also not available in Jenny, Match, and Quilt textiles.
- An optional ballistic nylon outer back, resistant to impact damage is available in Black only. Please specify (BKB). Add \$15.
- For availability of chair series in Vinyl, please contact a Global Sales Representative.

DESCRIPTION FEATURES MODEL# STANDARD TEXTILE GRADES



**HB Heavy Duty Multi-Tilter**  
COM Yardage: 3.25  
Freight Class: 250  
Product Weight (lbs.): 118  
Cubic Feet Per Carton: 33.50

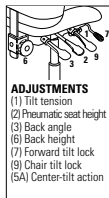

Ergonomic Features:  
A, B, C, F, G, M, N, S

MODEL#	1	2	3	4	5	6	7	8	9	10	11	12
2526	-	1936	2002	2103	2244	2297	2420	2653	2769	2984	3285	3655

OVERALL DIMENSIONS			SEAT DIMENSIONS			BACK DIMENSIONS	
W	D	H	W	D	H	W	H
29	27.5	50.5	25.5	20	16.5-20.5	22	30

RTA 00



**MB Heavy Duty Multi-Tilter**  
COM Yardage: 3  
Freight Class: 250  
Product Weight (lbs.): 114  
Cubic Feet Per Carton: 29.50

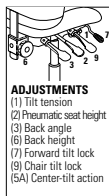

Ergonomic Features:  
A, B, C, F, G, M, N, S

MODEL#	1	2	3	4	5	6	7	8	9	10	11	12
2527	-	1822	1883	1975	2105	2154	2269	2483	2591	2790	3067	3409

OVERALL DIMENSIONS			SEAT DIMENSIONS			BACK DIMENSIONS	
W	D	H	W	D	H	W	H
29	26.5	42.5	25.5	20	16.5-20.5	22	24

RTA 00

## SAXON



model 2512-3



Back

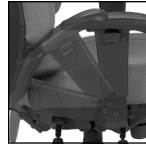

### Arm Feature

Arms are designed to flip up and accommodate people wearing equipment belts.

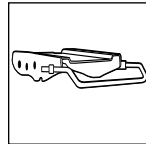

### Multi-Depth Mechanism



Standard on all models. Allows seat to move forward and backward over a 2" range with 5 locking positions to provide a more shallow or deeper seat.

## STANDARD FEATURES

- A contoured molded, Dual cushion Ultracell® foam seat and heavily padded back provides exceptional comfort.
- Rated for multi shift use by persons up to 350 pounds.
- Standard with a five-legged, injection molded base in Black (BK) Only.
- Standard with VL "fold up" arms. Arms fold up to accommodate users that wear equipment belts, such as Policemen and 911 Operators.
- Standard with Vari-Width Adapter Plate (WA).
- Standard with ratchet back height adjustment.

## OPTIONAL FEATURES

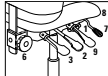
- Memory foam seats optionally available. This slow release foam moulds to contours and evenly distributes body weight. Please specify (MF), Add \$84.
- Ballistic nylon outer back fabric is standard and resistant to impact damage. Available in Black Only.
- C10 casters are standard. Please see page 309 for additional caster options. Optional caster may be priced higher than the standard casters and will incur and upcharge. Lower priced optional casters will not be credited.
- For availability of chair series in Vinyl, please contact a Global Sales Representative.
- Not available in Leather.

DESCRIPTION	FEATURES	MODEL#	STANDARD TEXTILE GRADES																													
			1	2	3	4	5	6	7	8	9	10	11	12																		
 <p><b>HB Heavy Duty Multi-Titer</b> COM Yardage: 2.25 Freight Class: 150 Product Weight (lbs.): 60 Cubic Feet Per Carton: 13</p>	 <p><b>ADJUSTMENTS</b> (1) Tilt tension (2) Pneumatic seat height (3) Back angle (6) Back height (7) Forward tilt lock (8) Seat depth (9) Chair tilt lock (6A) Center-tilt action</p>	<b>2512-3</b>	-	1339	1389	1460	1564	1603	1692	1861	1946	2103	2321	2590																		
		<table border="1"> <thead> <tr> <th colspan="3">OVERALL DIMENSIONS</th> <th colspan="3">SEAT DIMENSIONS</th> <th colspan="2">BACK DIMENSIONS</th> </tr> <tr> <th>W</th> <th>D</th> <th>H</th> <th>W</th> <th>D</th> <th>H</th> <th>W</th> <th>H</th> </tr> </thead> <tbody> <tr> <td>27.5</td> <td>25</td> <td>39.5</td> <td>22.5</td> <td>19-21.5</td> <td>18-22</td> <td>20</td> <td>19.5-22</td> </tr> </tbody> </table>			OVERALL DIMENSIONS			SEAT DIMENSIONS			BACK DIMENSIONS		W	D	H	W	D	H	W	H	27.5	25	39.5	22.5	19-21.5	18-22	20	19.5-22	<p>Ergonomic Features: A, B, C, M, N, S</p>			<p>RTA 2 </p>
OVERALL DIMENSIONS			SEAT DIMENSIONS			BACK DIMENSIONS																										
W	D	H	W	D	H	W	H																									
27.5	25	39.5	22.5	19-21.5	18-22	20	19.5-22																									

VION



model TS6321-3

model TS6331-3

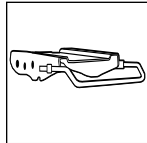

**Multi-Depth Mechanism**  
Allows seat to move forward and backward over a 2" range with 5 locking positions to provide a more shallow or deeper seat.

VION FINISHES - TASK SEATING				
Back Frame	Base	Specify Code	Arm Option	Specify Code
Black	Black	BK	Adj. "T" arm (Black) Adj. "T" arm, fixed armcap (Black) Fixed "C" arm (Black)	AS AF C
Black	Polished Aluminum	BA Add \$121	Adj. "T" arm (Black, Chrome accent) Adj. "T" arm, fixed armcap (Black, Chrome accent) Fixed "C" arm (Black) Fixed "C" arm (Polished aluminum)	AC AD C CA - Add \$147
Fog	Fog	FG Add \$55	Adj. "T" arm (Fog) Adj. "T" arm, fixed armcap (Fog) Fixed "C" arm (Fog)	FA FF CC
Fog	Polished Aluminum	FA Add \$176	Adj. "T" arm (Fog, Chrome accent) Adj. "T" arm, fixed armcap (Fog, Chrome accent) Fixed "C" arm (Fog) Fixed "C" arm (Polished Aluminum)	FC CF CC CA - Add \$147

\* All arms have Black SSU Armcaps.

STANDARD FEATURES

- The TS models are available within standard Vion series. TS stands for "Three Shift" and each of the TS models are rated for 24-7 applications as well as weight rated up to 350 pounds.
- Multi-Tilter models, feature a heavy duty mechanism.
- Multi-Tilters are standard with Pneumatic seat height and sliding seat depth adjustment. Forward and rearward seat tilt with infinite lock and free floating back angle control. Tilt tension control.
- Side activated sliding seat depth adjustment (MD) is standard on Multi-Tilter. Provides 2" of seat depth adjustment.
- Heavy duty drafting stools are standard with fixed back. Seat depth and pneumatic seat height adjustments. Swivels with adjustable chrome footring.
- All models are standard with either Ultracell or molded heavy duty seat foam.
- All models have a heavy duty 3" wide back upright.
- All models are standard with height and width adjustable arms (AS) that feature a front to back sliding armcap.
- Upholstered back models will always feature black fabric (Jenny JN02) on the back side.

OPTIONAL FEATURES

- Mesh back models are available in 10 colors: Aqua (MS75), Black (MS69), Black Cherry (MS76), Blue (MS72), Dust (MS77), Ivory (MS78), Natural (MS74), Paprika (MS79), Rope (MS73) and Stone (MS71).
- Upholstered back models offer a Matching Outer (MO) upholstery option. Due to the additional material needed, these models are listed separately and are priced differently than the standard upholstered back models.
- Two featured "T" arm options that include height and width adjusting arms, one with sliding arm caps (AS) and one without sliding arm caps (AF). Also, available is a stylish fixed urethane arm (C) for conference/management environments.
- Optional Lumbar Pad can be added at the time of order. Please specify LP. Add \$28. Lumbar Pad can also be order after sale as a kit, specify model 6339 at \$28 list. The Lumbar Pad is adjustable up to 3".
- Optional Memory Foam available on Vion Seats. Please specify MF. Add \$84.
- B7A Polished aluminum base and matching chrome arm accent on either AS or AF arms. Please specify ALU and AC. Add \$121.
- Grade 2 and above textiles (or 100,000+ rubs) are recommended for 24-7 applications. All models are available in fabric, vinyl or leather.

DESCRIPTION FEATURES MODEL# STANDARD TEXTILE GRADES



**HB Heavy Duty Multi - Tilter - Mesh Back**  
COM Yardage: 1.75  
Freight Class: 150  
Product Weight (lbs.): 49  
Cubic Feet Per Carton: 9.75

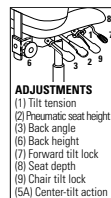

**Vion TS**  
  
Ergonomic Features:  
A, B, C, E, F, G, H, M, N, Q, U, S

MODEL#	STANDARD TEXTILE GRADES											
	1	2	3	4	5	6	7	8	9	10	11	12
TS6321-3	951	977	997	1028	1071	1087	1124	1197	1232	1299	1391	1504
TS6321L-3 Leather	-	-	-	-	-	-	-	1162	1210	1268	1369	1483
OVERALL DIMENSIONS			SEAT DIMENSIONS			BACK DIMENSIONS						
W	D	H	W	D	H	W	H					
25.5	24	41	20	17-19.5	17.5-21.5	19	21.5-24					





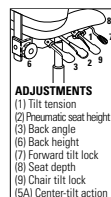





**MB Heavy Duty Multi - Tilter - Mesh Back**  
COM Yardage: 1.75  
Freight Class: 150  
Product Weight (lbs.): 49  
Cubic Feet Per Carton: 9.75

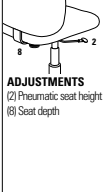

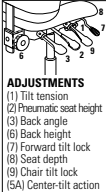
**Vion TS**  
  
Ergonomic Features:  
A, B, C, E, F, G, H, M, N, Q, U, S

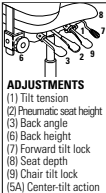
MODEL#	STANDARD TEXTILE GRADES											
	1	2	3	4	5	6	7	8	9	10	11	12
TS6322-3	913	940	960	991	1034	1050	1087	1160	1195	1262	1354	1468
TS6322L-3 Leather	-	-	-	-	-	-	-	1124	1172	1230	1331	1445
OVERALL DIMENSIONS			SEAT DIMENSIONS			BACK DIMENSIONS						
W	D	H	W	D	H	W	H					
25.5	24	39	20	17-19.5	17.5-21.5	19	21.5-24					

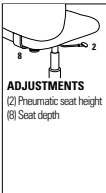

DESCRIPTION	FEATURES	MODEL#	STANDARD TEXTILE GRADES																																																																																																				
			1	2	3	4	5	6	7	8	9	10	11	12																																																																																									
 <p><b>MB Heavy Duty Drafting Stool - Mesh Back</b> COM Yardage: 1.75 Freight Class: 150 Product Weight (lbs.): 49 Cubic Feet Per Carton: 9.75</p>	 <p><b>ADJUSTMENTS</b> (2) Pneumatic seat height (8) Seat depth</p>	<p><b>Vion S</b></p> <p>Ergonomic Features: A, B, C, D, F, G, H, M, N, Q, S</p>	<table border="1"> <tr> <td><b>S6328-6</b></td><td>734</td><td>763</td><td>786</td><td>819</td><td>869</td><td>886</td><td>929</td><td>1011</td><td>1050</td><td>1125</td><td>1228</td><td>1357</td> </tr> <tr> <td><b>S6328L-6</b></td><td>-</td><td>-</td><td>-</td><td>-</td><td>-</td><td>-</td><td>-</td><td>882</td><td>929</td><td>988</td><td>1088</td><td>1201</td> </tr> <tr> <td colspan="12">Leather</td> </tr> <tr> <td colspan="3"><b>OVERALL DIMENSIONS</b></td> <td colspan="3"><b>SEAT DIMENSIONS</b></td> <td colspan="6"><b>BACK DIMENSIONS</b></td> </tr> <tr> <td><b>W</b></td><td><b>D</b></td><td><b>H</b></td> <td><b>W</b></td><td><b>D</b></td><td><b>H</b></td> <td><b>W</b></td><td><b>D</b></td><td><b>H</b></td> <td><b>W</b></td><td><b>H</b></td> <td colspan="2"></td> </tr> <tr> <td>25.5</td><td>24</td><td>48</td> <td>20</td><td>17.5</td><td>23.5-33.5</td> <td>19</td><td colspan="2">21.5-24</td> <td colspan="3"></td> </tr> </table>												<b>S6328-6</b>	734	763	786	819	869	886	929	1011	1050	1125	1228	1357	<b>S6328L-6</b>	-	-	-	-	-	-	-	882	929	988	1088	1201	Leather												<b>OVERALL DIMENSIONS</b>			<b>SEAT DIMENSIONS</b>			<b>BACK DIMENSIONS</b>						<b>W</b>	<b>D</b>	<b>H</b>	<b>W</b>	<b>D</b>	<b>H</b>	<b>W</b>	<b>D</b>	<b>H</b>	<b>W</b>	<b>H</b>			25.5	24	48	20	17.5	23.5-33.5	19	21.5-24																		
			<b>S6328-6</b>	734	763	786	819	869	886	929	1011	1050	1125	1228	1357																																																																																								
			<b>S6328L-6</b>	-	-	-	-	-	-	-	882	929	988	1088	1201																																																																																								
			Leather																																																																																																				
<b>OVERALL DIMENSIONS</b>			<b>SEAT DIMENSIONS</b>			<b>BACK DIMENSIONS</b>																																																																																																	
<b>W</b>	<b>D</b>	<b>H</b>	<b>W</b>	<b>D</b>	<b>H</b>	<b>W</b>	<b>D</b>	<b>H</b>	<b>W</b>	<b>H</b>																																																																																													
25.5	24	48	20	17.5	23.5-33.5	19	21.5-24																																																																																																
			<p><b>RTA 2</b> </p>																																																																																																				
 <p><b>HB Heavy Duty Multi - Tilter - Upholstered Back</b> COM Yardage: 1.75 Freight Class: 150 Product Weight (lbs.): 49 Cubic Feet Per Carton: 9.75</p>	 <p><b>ADJUSTMENTS</b> (1) Tilt tension (2) Pneumatic seat height (3) Back angle (6) Back height (7) Forward tilt lock (8) Seat depth (9) Chair tilt lock (5A) Center-tilt action</p>	<p><b>Vion TS</b></p> <p>Ergonomic Features: A, B, C, E, F, G, H, M, N, Q, U, S</p>	<table border="1"> <tr> <td><b>TS6331-3</b></td><td>1049</td><td>1083</td><td>1108</td><td>1146</td><td>1200</td><td>1221</td><td>1267</td><td>1358</td><td>1401</td><td>1486</td><td>1600</td><td>1742</td> </tr> <tr> <td><b>TS6331-3MO</b></td><td>1091</td><td>1124</td><td>1150</td><td>1188</td><td>1243</td><td>1262</td><td>1309</td><td>1399</td><td>1444</td><td>1527</td><td>1642</td><td>1783</td> </tr> <tr> <td><b>TS6331L-3</b></td><td>-</td><td>-</td><td>-</td><td>-</td><td>-</td><td>-</td><td>-</td><td>1341</td><td>1399</td><td>1473</td><td>1598</td><td>1740</td> </tr> <tr> <td><b>TS6331L-3MO</b></td><td>-</td><td>-</td><td>-</td><td>-</td><td>-</td><td>-</td><td>-</td><td>1558</td><td>1617</td><td>1690</td><td>1815</td><td>1957</td> </tr> <tr> <td colspan="3"><b>OVERALL DIMENSIONS</b></td> <td colspan="3"><b>SEAT DIMENSIONS</b></td> <td colspan="6"><b>BACK DIMENSIONS</b></td> </tr> <tr> <td><b>W</b></td><td><b>D</b></td><td><b>H</b></td> <td><b>W</b></td><td><b>D</b></td><td><b>H</b></td> <td><b>W</b></td><td><b>D</b></td><td><b>H</b></td> <td><b>W</b></td><td><b>H</b></td> <td colspan="2"></td> </tr> <tr> <td>25.5</td><td>24</td><td>41</td> <td>20</td><td>17-19.5</td><td>17.5-21.5</td> <td>19</td><td colspan="2">21.5-24</td> <td colspan="3"></td> </tr> </table>												<b>TS6331-3</b>	1049	1083	1108	1146	1200	1221	1267	1358	1401	1486	1600	1742	<b>TS6331-3MO</b>	1091	1124	1150	1188	1243	1262	1309	1399	1444	1527	1642	1783	<b>TS6331L-3</b>	-	-	-	-	-	-	-	1341	1399	1473	1598	1740	<b>TS6331L-3MO</b>	-	-	-	-	-	-	-	1558	1617	1690	1815	1957	<b>OVERALL DIMENSIONS</b>			<b>SEAT DIMENSIONS</b>			<b>BACK DIMENSIONS</b>						<b>W</b>	<b>D</b>	<b>H</b>	<b>W</b>	<b>D</b>	<b>H</b>	<b>W</b>	<b>D</b>	<b>H</b>	<b>W</b>	<b>H</b>			25.5	24	41	20	17-19.5	17.5-21.5	19	21.5-24				
			<b>TS6331-3</b>	1049	1083	1108	1146	1200	1221	1267	1358	1401	1486	1600	1742																																																																																								
			<b>TS6331-3MO</b>	1091	1124	1150	1188	1243	1262	1309	1399	1444	1527	1642	1783																																																																																								
			<b>TS6331L-3</b>	-	-	-	-	-	-	-	1341	1399	1473	1598	1740																																																																																								
<b>TS6331L-3MO</b>	-	-	-	-	-	-	-	1558	1617	1690	1815	1957																																																																																											
<b>OVERALL DIMENSIONS</b>			<b>SEAT DIMENSIONS</b>			<b>BACK DIMENSIONS</b>																																																																																																	
<b>W</b>	<b>D</b>	<b>H</b>	<b>W</b>	<b>D</b>	<b>H</b>	<b>W</b>	<b>D</b>	<b>H</b>	<b>W</b>	<b>H</b>																																																																																													
25.5	24	41	20	17-19.5	17.5-21.5	19	21.5-24																																																																																																
			<p><b>RTA 2</b> </p>																																																																																																				
 <p><b>MB Heavy Duty Multi - Tilter - Upholstered Back</b> COM Yardage: 1.75 Freight Class: 150 Product Weight (lbs.): 49 Cubic Feet Per Carton: 9.75</p>	 <p><b>ADJUSTMENTS</b> (1) Tilt tension (2) Pneumatic seat height (3) Back angle (6) Back height (7) Forward tilt lock (8) Seat depth (9) Chair tilt lock (5A) Center-tilt action</p>	<p><b>Vion TS</b></p> <p>Ergonomic Features: A, B, C, E, F, G, H, M, N, Q, U, S</p>	<table border="1"> <tr> <td><b>TS6332-3</b></td><td>1011</td><td>1044</td><td>1069</td><td>1107</td><td>1161</td><td>1181</td><td>1228</td><td>1319</td><td>1362</td><td>1447</td><td>1561</td><td>1703</td> </tr> <tr> <td><b>TS6332-3MO</b></td><td>1055</td><td>1112</td><td>1156</td><td>1223</td><td>1317</td><td>1361</td><td>1448</td><td>1584</td><td>1689</td><td>1806</td><td>2047</td><td>2304</td> </tr> <tr> <td><b>TS6332L-3</b></td><td>-</td><td>-</td><td>-</td><td>-</td><td>-</td><td>-</td><td>-</td><td>1197</td><td>1256</td><td>1330</td><td>1455</td><td>1597</td> </tr> <tr> <td><b>TS6332L-3MO</b></td><td>-</td><td>-</td><td>-</td><td>-</td><td>-</td><td>-</td><td>-</td><td>1398</td><td>1492</td><td>1610</td><td>1810</td><td>2038</td> </tr> <tr> <td colspan="3"><b>OVERALL DIMENSIONS</b></td> <td colspan="3"><b>SEAT DIMENSIONS</b></td> <td colspan="6"><b>BACK DIMENSIONS</b></td> </tr> <tr> <td><b>W</b></td><td><b>D</b></td><td><b>H</b></td> <td><b>W</b></td><td><b>D</b></td><td><b>H</b></td> <td><b>W</b></td><td><b>D</b></td><td><b>H</b></td> <td><b>W</b></td><td><b>H</b></td> <td colspan="2"></td> </tr> <tr> <td>25.5</td><td>24</td><td>41</td> <td>20</td><td>17-19.5</td><td>17.5-21.5</td> <td>19</td><td colspan="2">21.5-24</td> <td colspan="3"></td> </tr> </table>												<b>TS6332-3</b>	1011	1044	1069	1107	1161	1181	1228	1319	1362	1447	1561	1703	<b>TS6332-3MO</b>	1055	1112	1156	1223	1317	1361	1448	1584	1689	1806	2047	2304	<b>TS6332L-3</b>	-	-	-	-	-	-	-	1197	1256	1330	1455	1597	<b>TS6332L-3MO</b>	-	-	-	-	-	-	-	1398	1492	1610	1810	2038	<b>OVERALL DIMENSIONS</b>			<b>SEAT DIMENSIONS</b>			<b>BACK DIMENSIONS</b>						<b>W</b>	<b>D</b>	<b>H</b>	<b>W</b>	<b>D</b>	<b>H</b>	<b>W</b>	<b>D</b>	<b>H</b>	<b>W</b>	<b>H</b>			25.5	24	41	20	17-19.5	17.5-21.5	19	21.5-24				
			<b>TS6332-3</b>	1011	1044	1069	1107	1161	1181	1228	1319	1362	1447	1561	1703																																																																																								
			<b>TS6332-3MO</b>	1055	1112	1156	1223	1317	1361	1448	1584	1689	1806	2047	2304																																																																																								
			<b>TS6332L-3</b>	-	-	-	-	-	-	-	1197	1256	1330	1455	1597																																																																																								
<b>TS6332L-3MO</b>	-	-	-	-	-	-	-	1398	1492	1610	1810	2038																																																																																											
<b>OVERALL DIMENSIONS</b>			<b>SEAT DIMENSIONS</b>			<b>BACK DIMENSIONS</b>																																																																																																	
<b>W</b>	<b>D</b>	<b>H</b>	<b>W</b>	<b>D</b>	<b>H</b>	<b>W</b>	<b>D</b>	<b>H</b>	<b>W</b>	<b>H</b>																																																																																													
25.5	24	41	20	17-19.5	17.5-21.5	19	21.5-24																																																																																																
			<p><b>RTA 2</b> </p>																																																																																																				
 <p><b>MB Heavy Duty Drafting Stool - Upholstered Back</b> COM Yardage: 1 Freight Class: 150 Product Weight (lbs.): 47 Cubic Feet Per Carton: 10.50</p>	 <p><b>ADJUSTMENTS</b> (2) Pneumatic seat height (8) Seat depth</p>	<p><b>Vion S</b></p> <p>Ergonomic Features: C, E, M, N</p>	<table border="1"> <tr> <td><b>S6338-6</b></td><td>824</td><td>861</td><td>889</td><td>933</td><td>993</td><td>1015</td><td>1069</td><td>1171</td><td>1219</td><td>1315</td><td>1444</td><td>1604</td> </tr> <tr> <td><b>S6338L-6</b></td><td>-</td><td>-</td><td>-</td><td>-</td><td>-</td><td>-</td><td>-</td><td>1104</td><td>1162</td><td>1236</td><td>1361</td><td>1503</td> </tr> <tr> <td colspan="3"><b>OVERALL DIMENSIONS</b></td> <td colspan="3"><b>SEAT DIMENSIONS</b></td> <td colspan="6"><b>BACK DIMENSIONS</b></td> </tr> <tr> <td><b>W</b></td><td><b>D</b></td><td><b>H</b></td> <td><b>W</b></td><td><b>D</b></td><td><b>H</b></td> <td><b>W</b></td><td><b>D</b></td><td><b>H</b></td> <td><b>W</b></td><td><b>H</b></td> <td colspan="2"></td> </tr> <tr> <td>25.5</td><td>24</td><td>48</td> <td>20</td><td>17.5</td><td>23.5-33.5</td> <td>18.5</td><td colspan="2">21</td> <td colspan="3"></td> </tr> </table>												<b>S6338-6</b>	824	861	889	933	993	1015	1069	1171	1219	1315	1444	1604	<b>S6338L-6</b>	-	-	-	-	-	-	-	1104	1162	1236	1361	1503	<b>OVERALL DIMENSIONS</b>			<b>SEAT DIMENSIONS</b>			<b>BACK DIMENSIONS</b>						<b>W</b>	<b>D</b>	<b>H</b>	<b>W</b>	<b>D</b>	<b>H</b>	<b>W</b>	<b>D</b>	<b>H</b>	<b>W</b>	<b>H</b>			25.5	24	48	20	17.5	23.5-33.5	18.5	21																														
			<b>S6338-6</b>	824	861	889	933	993	1015	1069	1171	1219	1315	1444	1604																																																																																								
			<b>S6338L-6</b>	-	-	-	-	-	-	-	1104	1162	1236	1361	1503																																																																																								
			<b>OVERALL DIMENSIONS</b>			<b>SEAT DIMENSIONS</b>			<b>BACK DIMENSIONS</b>																																																																																														
<b>W</b>	<b>D</b>	<b>H</b>	<b>W</b>	<b>D</b>	<b>H</b>	<b>W</b>	<b>D</b>	<b>H</b>	<b>W</b>	<b>H</b>																																																																																													
25.5	24	48	20	17.5	23.5-33.5	18.5	21																																																																																																
			<p><b>RTA 2</b> </p>																																																																																																				





# arm and caster options



# HOW TO SELECT ARMRESTS

Global has a wide selection of armrest to suit almost every work task. Armrest are an important feature of a chair. They reduce stress an tension on the spine, neck and shoulder muscles by supporting the weight of your arms. This makes you more comfortable and ultimately more productive. Height, width and angle adjustable armrests enable you to position your arms at a comfortable working position, based on the task at hand.

## COMFORT TIPS

- Wrists should be in a straight or neutral position - avoid bending your wrists
- When mousing, use whole arm movements instead of flexing your wrist.
- Rest your palm on the mouse pad for support.

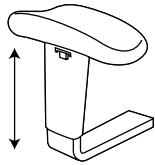

## HEIGHT ADJUSTABLE ARMS

- A full range of arms is available with armcaps in self-skinned urethane (SSU).
- Use the features available on Global's adjustable arms to accommodate your ergonomic requirements.

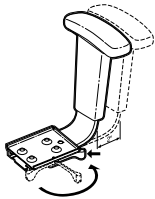

## VARI-WIDTH ARM

- Features maximum comfort while enabling you to maintain top productivity levels.
- Easy to use levers enable you to adjust the distance between armrests quickly and simply. An ergonomic feature, Vari-Width maximizes shoulder support as it accommodates the specific width requirements of each user.
- Metal adapter plates provide width adjustability. One adapter plate is attached under each side of the seat. Arms are inserted into the adapter plates.
- Arms extend outward up to 2" on each side. A lever locks each arm in any position.
- Vari-Width is available only with Global's height adjustable arms. The arm chart (on the following pages) specifies all arm options available for the Vari-Width series. Vari-Width is standard on many chairs; they can also be retroactively installed on chairs.
- When ordering, please specify series, arm and **(WA)** ie. Loover 2660-0 (**G5**) and **(WA)**. When ordering as retrofit, please specify **2660-0-WA**.

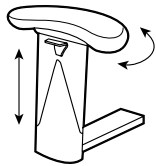

## ROTATING ARMCAPS

Rotating armcaps articulate inward and/or outward. This positions the arm to support mousing or keyboarding activities. Rotating armcaps can also be used to narrow the space between the arms for slender people seeking arm support while keyboarding.

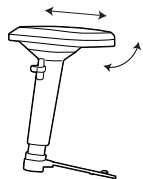

## SLIDING ARMCAPS

Select arms have sliding armcaps. They can slide over top of the seat to narrow the space between the arms for smaller users. Sliding armcaps also slide forward for arm support for larger users or slide to the rear allowing slender users to sit closer to their worksurface.

## OPTIONAL ARMS

Purchased separately from the chair. Cost listed below arm descriptions. Refer to chart for series compatibility.

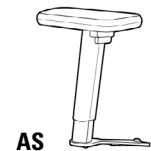

**AS**

Height and width adjustable forward and backward sliding armcaps.

**\$199**

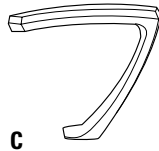

**C**

Fixed height and stylish "C" arm. Self-skinned urethane. Black only.

**\$199**

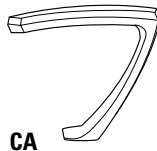

**CA**

Fixed height and stylish "C" arm. Polished Aluminum.

**\$315**

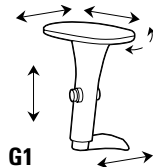

**G1**

Height and width adjustable forward and backward sliding armcaps. Self-skinned urethane pad rotates inward.

**\$199**



**G2**

Special low rise version of G3 arm, positions 1" lower but retains all G3 functions.

**\$199**

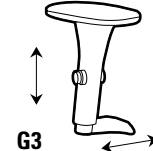

**G3**

Height and width adjustable forward and backward sliding armcaps. Self-skinned urethane pad rotates inward 30 degrees.

**\$199**



**G4**

Height adjustable "T" style Graphic arm. Self-Skinned Urethane (SSU) armcap. Slides forward and back.

**\$199**

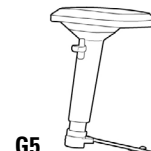

**G5**

Lockable, highly adjustable armcap slides forward and backward, cap slides over seat 3/4" each side, cap rotates inward & outward. Soft (SSU) arm pad.

**\$199**



**G6**

Special low rise version of G5 arm, positions 1" lower but retains all G5 arm functions.

**\$199**

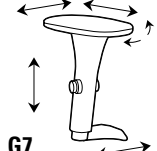

**G7**

Wider highly adjustable armcap slides forward and backward, cap slides over seat 3/4" each side. Cap rotates inward. Soft SSU arm pad. Curved corners and sides.

**\$199**

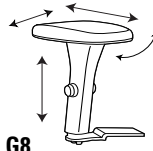

**G8**

Special low rise version of G7 arm, positions 1" lower but retains all G7 functions.

**\$199**

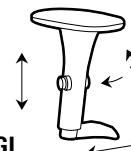

**GL**

Height and width adjustable forward and backward sliding armcaps.

**\$199**

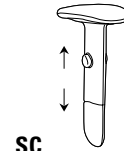

**SC**

Height adjustable forward swept arms with kidney shaped armcaps. Self-skinned urethane.

**\$174**

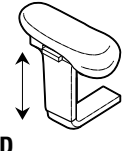

**TD**

Height adjustable "T" arms with teardrop shaped armcaps.

Self-skinned urethane.

**\$174**



**T6**

Height adj. T arm. Rotates 360. Self-skinned urethane.

**\$233**

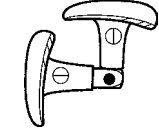

**ZT**

Height adjustable "T" arms, teardrop shaped. Swings away and folds. Self-skinned urethane.

**\$212**



**3B**

Height Adjustable "T" arm with soft touch Self-Skinned Urethane (SSU) armcap.

**\$174**

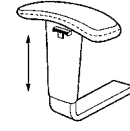

**3N**

Height adjustable "T" arms with curved shaped armcaps. Self-skinned urethane. Available in Black only.

**\$141**

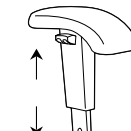

**3P**

Height adjustable "waterfall edge" arms. Self-skinned urethane. Available in Black Only.

**\$174**



**3R**

Hard durometer. Height Adjustable "T" arm with Concave Oval soft touch Self-Skinned Urethane (SSU) armcap.

**\$174**



# ARM SELECTIONS

SERIES \ ARMS	STD	AS	C	CA	G1	G2	G3	G4	G5	G6	G7	G8
ALERO	GL	0	0	149	0	0	0	0	0	0	0	0
ASPEN	AS	STD	NA	NA	0	NA	0	0	0	NA	0	0
DEXTER	3R	29	NA	NA	29	29	29	29	29	29	29	29
ENTERPRISE	TD	29	NA	NA	29	29	29	29	29	29	29	29
GOAL	3N	NR	65	NA	NR	NR	NR	NR	NR	NR	NR	NR
GRAHAM	3N	65	NA	NA	65	65	65	65	65	65	65	65
GRANADA	3N	65	NA	NA	65	65	65	65	65	65	NR	NR
GRANADA DELUXE	3B	29	NA	NA	29	29	29	29	29	29	29	29
GRAPHIC	G4	0	0	149	0	NA	0		0	NA	0	0
LOOVER	G5	0	0	149	0	0	0	0	STD	0	0	0
MALAGA	TD	29	NA	NA	29	29	29	29	29	29	29	29
OBUSFORME COMFORT	G3	0	NA	NA	0	0	STD	0	0	0	0	0
SAXON	VL	0	NA	NA	0	0	0	0	0	0	0	0
SOFTCURVE LM	SC	29	29	149	29	29	29	29	29	29	29	29
SUPRA X	SC	29	29	176	29	29	29	29	29	29	29	29
SYNOPSIS	3B	29	29	176	29	29	29	29	29	29	29	29
TAMIRI	TD	29	NA	NA	29	29	29	29	29	29	29	29
TRIUMPH	G1	0	NA	NA	STD	NA	0	0	0	NA	NA	NA
TRUFORM	SC	29	29	176	29	29	29	29	29	29	29	29
TYE	3N	65	NA	NA	65	65	65	65	65	65	65	65
VION	AS/C	STD	STD	149	0	0	0	0	0	0	0	0
WEEV	GL	0	0	149	0	0	0	0	0	0	0	0

**NOTE:** ARMCHAIRS HAVE FIXED ARMS WHICH ARE NOT INTERCHANGEABLE WITH ADJUSTABLE ARMS LISTED ABOVE.  
 \* INDICATES THAT ARMS CAN NOT BE USED WITH "WA" ARM WIDTH ADAPTER.

**SD** = AVAILABLE AT NO ADDITIONAL CHARGE

**NA** = NOT AVAILABLE

**NR** = OPTION NOT RECOMMENDED

SERIES \ ARMS	STD	GL	SC	TD	T6	ZT	3B	3N	3P	3R	WA
<b>ALERO</b>	GL	<b>STD</b>	0	0	55	15	0	0	0	0	59
<b>ASPEN</b>	AS	0	NR	NR	NA	NA	NR	NR	NR	NR	<b>STD</b>
<b>DEXTER</b>	3R	29	NR	0	84	44	0	0	0	<b>STD</b>	<b>STD</b>
<b>ENTERPRISE</b>	G1	29	0	0	84	44	0	0	0	0	<b>STD</b>
<b>GOAL</b>	3N	NR	37	37	NR	80	37	<b>STD</b>	37	37	59
<b>GRAHAM</b>	3N	65	37	37	120	80	37	<b>STD</b>	37	37	59
<b>GRANADA</b>	3N	65	37	37	120	80	37	<b>STD</b>	37	37	<b>STD</b>
<b>GRANADA DELUXE</b>	3B	29	0	0	84	44	<b>STD</b>	0	0	0	<b>STD</b>
<b>GRAPHIC</b>	G4	0	0	NR	0	15	NR	NR	NR	NR	<b>STD</b>
<b>LOOVER</b>	G5	0	0	0	0	NA	0	0	0	0	0
<b>MALAGA</b>	TD	29	0	<b>STD</b>	84	44	0	0	0	0	<b>STD</b>
<b>OBUSFORME COMFORT</b>	G3	0	0	0	57	14	0	0	0	0	<b>STD</b>
<b>SAXON</b>	VL	0	0	NR	57	NR	0	0	0	0	NA
<b>SOFTCURVE LM</b>	SC	29	<b>STD</b>	0	84	44	0	0	0	0	59
<b>SUPRA X</b>	SC	29	<b>STD</b>	0	84	44	0	0	0	0	<b>STD</b>
<b>SYNOPSIS</b>	3B	29	0	0	84	44	<b>STD</b>	0	0	0	<b>STD</b>
<b>TAMIRI</b>	TD	29	0	<b>STD</b>	84	44	0	0	0	0	59
<b>TRIUMPH</b>	G1	0	NA	NA	NA	NA	NA	NA	NA	NA	NA
<b>TRUFORM</b>	SC	29	<b>STD</b>	0	84	44	0	0	0	0	NA
<b>TYE</b>	3N	65	34	34	120	80	37	<b>STD</b>	37	37	59
<b>VION</b>	AS/C	0	0	0	55	NA	0	0	0	0	0
<b>WEEV</b>	GL	<b>STD</b>	0	0	55	15	0	0	0	0	<b>STD</b>

**NOTE:** ARMCHAIRS HAVE FIXED ARMS WHICH ARE NOT INTERCHANGEABLE WITH ADJUSTABLE ARMS LISTED ABOVE.  
 \* INDICATES THAT ARMS CAN NOT BE USED WITH "WA" ARM WIDTH ADAPTER.

**\$0** = AVAILABLE AT NO ADDITIONAL CHARGE

**NA** = NOT AVAILABLE

**NR** = OPTION NOT RECOMMENDED

# CASTER SELECTIONS

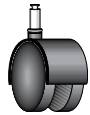

C1	2" Dual Wheel Caster	Black	Carpeted Floor	1 each set of 5	<b>13</b> <b>59</b>
----	----------------------	-------	----------------	--------------------	------------------------

**Available on:** Softcurve and Traditional bases.



C7	Slipper Glide (allows chair to remain at caster height)	Black	Any surface	1 each set of 5	<b>13</b> <b>59</b>
----	---	-------	-------------	--------------------	------------------------

**Available on:** All bases

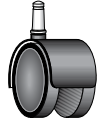

C9R	2 1/2" Dual Wheel Rubber Coated Caster	Black	Vinyl, Marble, Hardwood Floor	1 each set of 5	<b>23</b> <b>110</b>
-----	---	-------	----------------------------------	--------------------	-------------------------

**Available on:** All bases



C10	2" Integrated Dual Wheel Caster	Black	Carpeted Floor	1 each set of 5	<b>21</b> <b>98</b>
-----	------------------------------------	-------	----------------	--------------------	------------------------

C10

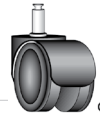

C10R	Integrated Dual Wheel Rubber Coated Caster	Black	Vinyl, Marble, Hardwood Floor	1 each set of 5	<b>30</b> <b>144</b>
------	---	-------	----------------------------------	--------------------	-------------------------

C10R

**Available on:** Concorde, Graham, Malaga, and Tamiri bases only.

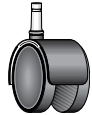

C14R	Automatic Locking Rubber Caster (while sitting)	Black	Any surface*	1 each set of 5	<b>53</b> <b>259</b>
------	---	-------	--------------	--------------------	-------------------------

**Available on:** All bases



C15	Manual Locking Caster (individual)	Black	Carpeted Floor	1 each set of 5	<b>28</b> <b>133</b>
-----	---------------------------------------	-------	----------------	--------------------	-------------------------

**Available on:** All bases



C65	2" Dual Wheel Caster	Black	Carpeted Floor	1 each set of 5	<b>13</b> <b>59</b>
-----	----------------------	-------	----------------	--------------------	------------------------

C65

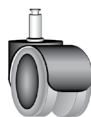











C65R	2" Dual Wheel Rubber Coated Caster	Black	Vinyl, Marble, Hardwood Floor	1 each set of 5	<b>23</b> <b>110</b>
------	---------------------------------------	-------	----------------------------------	--------------------	-------------------------

C65R

**Available on:** All bases (except wood base chairs).

## CASTER NOTES:

- The casters shown above are sold in sets for replacement purposes. This price list can also be used to calculate the upcharge to change casters at time of ordering a chair. Optional casters may be priced higher than the standard casters for your chair and the difference will be charged. Lower priced casters will not be credited.
- All casters are not appropriate for all flooring surfaces. Please consult with your sales representative or Global Customer Service representative for special situations that can be verified with the caster manufacturer. Alternative casters, if needed, may require an upcharge.
- \*Recommended for use on hard surface floors.

	MODEL #	MODEL NAME
	3G	<b>3" cylinder</b> Soft Descent™ pneumatic lift cylinder with 3 inch travel range. This lift cannot be used on synchro-tilter (-0) and multi-tilter (-3) mechanisms due to operational interference with controls.
	4F	<b>Fixed height swivel spindle #4</b> Fixed height, swivel only. Seat heights is determined by the spindle length which is preset at the factory and cannot be changed.
	4L	<b>4" cylinder, low rise</b> Soft Descent™ low rise, pneumatic lift cylinder with 4 inch travel range.
	5F	<b>Fixed height swivel spindle #5</b> Fixed height, swivel only. Seat heights is determined by the spindle length which is preset at the factory and cannot be changed.
	5L	<b>5" cylinder, low rise</b> Soft Descent™ low rise, pneumatic lift cylinder with 5 inch travel range.
	7G	<b>7" cylinder</b> Soft Descent™ pneumatic lift cylinder with 7 inch travel range. Lift allows most users to sit at both desk and counter heights. Seats may be too tall for shorter users at desk height.
	7R	<b>7" cylinder with 20" Chrome footrest</b> Soft Descent™ pneumatic lift cylinder with 7 inch travel range and adjustable footrest. Lift allows most users to sit at both desk and counter heights. Seats may be too tall for shorter users at desk height (refer to cylinder chart on page 376).
	SC	<b>Self-centering, height auto-return</b> Center and height return pneumatic lift cylinder with 2 inch travel range. Chair always swivels back to face the original direction so groups of chairs remain aligned. The seat height may be lowered by occupant, but chairs return to the maximum seat height when user exits the chair.
	SH	<b>Height auto-return, swivel</b> Height return pneumatic lift cylinder with 2 inch travel range. The seat height may be lowered by occupant, but chairs return to the maximum seat height when user exits the chair.
	SN	<b>Height auto-return, non-swivel</b> Height return pneumatic lift cylinder with 2 inch travel range. The seat height may be lowered by occupant, but chairs return to the maximum seat height when user exits the chair. Lift does not swivel.

**CYLINDER NOTES:**

- All cylinders are not appropriate for all mechanisms. Please refer to the following chart for compatibility and effect on minimum seat height.
- For cylinder upcharges and replacement costs, please contact Customer Service.



# CYLINDER SELECTIONS

SERIES	CYLINDER	STD	3G	4L	4F	5L	5F	7G	7R	SC	SH	SN
	Mechanism											
ACCORD	-2	4L	NA	STD	NA	+1.5	NA	+1.0	NA	NA	NA	NA
	-4	4G*	NA	NA	+0.5	NA	+1.0	+1.0	NA	+1.5	+1.5	+1.5
ASPEN	-3	4L	-0.75	STD	NA	+1.5	NA	+2.0	NA	NA	NA	NA
G1 ERGO SELECT	-0	4L	N/A	STD	NA	+1.5	NA	NA	NA	NA	NA	NA
	-3	4L	N/A	STD	NA	+1.5	NA	+2.0	NA	NA	NA	NA
	-8	4L	N/A	STD	NA	+1.5	NA	+2.0	NA	NA	NA	NA
G20		5L	-2.25	-1.5	NA	STD	NA	+1.0	NA	NA	NA	NA
GRANADA DELUXE	-2, -3	4L	NA	STD	NA	+1.5	NA	+2.0	NA	NA	NA	NA
	-5	4L	-0.75	STD	NA	+1.5	NA	+2.0	NA	NA	NA	NA
LOOVER	-3	4L	-0.75	STD	NA	+1.5	NA	+2.0	NA	NA	NA	NA
	-4	5L	-2.25	-1.5	NA	STD	+1.0	+1.0	+1.0	+1.75	+1.75	+1.75
	-8	5L	-2.25	-1.5	NA	STD	+1.0	+1.0	+1.0	+2.0	+2.0	+2.0
LURAY	-2	4L	NA	STD	NA	+1.5	NA	NA	NA	NA	NA	NA
	-4	5L	NA	-1.5	+0.5	STD	+1.0	+1.0	NA	+1.5	+1.5	+1.5
MALAGA	-1, -4	5L	-2.25	-1.5	NA	STD	NA	+1.0	NA	NA	NA	NA
	-2, -3	5L	NA	-1.5	NA	STD	NA	+1.0	NA	NA	NA	NA
NOVELLO		5L	-2.25	-1.5	NA	STD	NA	+1.0	NA	NA	NA	NA
OBUSFORME COMFORT	-2, -3	4L	NA	STD	NA	+1.5	NA	+2.0	NA	NA	NA	NA
	-5	4L	-0.75	STD	NA	+1.5	NA	NA	NA	NA	NA	NA
ROMA		4L*	-0.75	STD	NA	+1.5	+2.5	+2.0	NA	+2.0	+2.0	+2.0
SOFTCURVE LM	-1	5L	NA	-1.5	NA	STD	NA	NA	NA	NA	NA	NA
	-2, -3	4L	NA	STD	NA	+1.5	NA	NA	NA	NA	NA	NA
	-4	5L	NA	-1.5	NA	STD	+0.5	NA	NA	+2.0	+2.0	+2.0
SOLAR		4L*	NA	NA	+0.0	NA	+1.0	NA	NA	NA	NA	NA
SORA	-8	4L	-0.75	STD	NA	+1.5	NA	+2.0	+2.0	NA	NA	NA
SPREE		5L	-2.25	-1.5	NA	STD	NA	+1.0	NA	NA	NA	NA
SUPRA-X	-1, -4, -5	5L	-2.25	-1.5	NA	STD	NA	+1.0	NA	NA	NA	NA
	-3	5L	NA	-1.5	NA	STD	NA	+1.0	NA	NA	NA	NA
SYNOPSIS	-3	5L	NA	-1.5	NA	STD	NA	+1.0	NA	NA	NA	NA
	-4	5L	-2.25	-1.5	NA	STD	+1.0	+1.0	NA	+2.25	+2.25	+2.25
TRIUMPH	-3, -8	4L*	-0.75	STD	NA	+1.5	NA	+2.0	NA	NA	NA	NA
TRUFORM	-0, -3	5L	NA	-1.5	NA	STD	NA	+1.0	NA	NA	NA	NA
	-1, -4, -5	5L	NA	-1.5	NA	STD	NA	+1.0	NA	NA	NA	NA
	-8	5L	-2.25	-1.5	NA	STD	NA	+1.0	NA	NA	NA	NA
VION	-3	5L	-2.25	-1.5	NA	STD	NA	+1.0	+1.0	+1.75	+1.75	+1.5
	-4	5L	-2.25	-1.5	NA	STD	+1.0	+1.0	+1.0	+1.0	+1.0	+1.5
	-8	5L	-2.25	-1.5	NA	STD	+0.5	+1.0	NA	NA	NA	+1.5
WEEV	-3, -4, -8	5L	-2.25	-1.5	NA	STD	NA	+1.0	NA	NA	NA	NA

**NOTE:** CHART VALUES INDICATE CHANGE FROM STANDARD MINIMUM SEAT HEIGHT (IN INCHES).

\*SPECIAL CYLINDER

# DUET AND POPCORN GLIDE SELECTIONS

GLIDES	SURFACE	CARPET	VINYL SHEET	LVT	VCT	RUBBER	CORK	HARDWOOD	LAMINATE	CERAMIC TILE, STONE	MARBLE, GRANITE	CONCRETE
<b>NO GLIDE (XG):</b> The plain Chrome sled based frame slides easily and silently over carpeted surfaces. Note: do not use in damp areas.												
		●	NR	NR	NR	●	NR	NR	NR	NR	NR	NR
<b>CLEAR POLYCARBONATE GLIDE (CG):</b> The polycarbonate glide is easy to move over most flooring. It does not leave marks and it reduces noise on hard surfaces.												
		●	NR	NR	NR	●	NR	NR	NR	NR	NR	●
<b>STAINLESS STEEL PAD ON POLYCARBONATE GLIDE (SG):</b> The stainless steel bottomed glide slides easily. It is extremely durable, reduces floor contact and noise on hard surfaces.												
		●	NR	NR	NR	●	NR	NR	NR	NR	NR	NR
<b>FELT PAD ON POLY CARBONATE GLIDE (FG):</b> The felt bottomed glide moves silently and smoothly on hard surface flooring. Helps to prevent floor damage.												
		NR	●	●	●	NR	●	NR	●	NR	NR	NR
<b>RUBBER NO SLIP PAD ON POLY CARBONATE GLIDE (RG):</b> The rubber bottomed glide is slip-resistant. It grips flooring, reduces movement, scratching and eliminates noise.												
		NR	●	●	●	NR	NR	●	●	●	●	NR

**NOTE:** THE ABOVE IS ONLY A GUIDELINE BASED ON CLEAN AND PROPERLY FINISHED FLOORS. GLIDES THAT ARE NOT RECOMMENDED FOR USE WILL NOT BE COVERED BY GLOBAL'S LIFETIME WARRANTY. SITE CONDITIONS CAN DRAMATICALLY AFFECT HOW APPROPRIATE A GLIDE IS FOR ANY APPLICATION. REGULAR INSPECTION OF GLIDES IS CRITICAL TO PREVENTING FLOOR DAMAGE. SEE DESCRIPTIONS BELOW.

● = BEST FOR APPLICATION

NR = OPTION NOT RECOMMENDED

<b>NO GLIDE (XG):</b> The plain Chrome sled based frame slides easily and silently over carpeted surfaces. Note: do not use in damp areas.
<b>CLEAR POLYCARBONATE GLIDE (CG):</b> The polycarbonate glide is easy to move over most flooring. It does not leave marks and it reduces noise on hard surfaces.
<b>STAINLESS STEEL PAD ON POLYCARBONATE GLIDE (SG):</b> The stainless steel bottomed glide slides easily. It is extremely durable, reduces floor contact and noise on hard surfaces.
<b>FELT PAD ON POLYCARBONATE GLIDE (FG):</b> The felt bottomed glide moves silently and smoothly on hard surface flooring. Helps to prevent floor damage.
<b>RUBBER NO SLIP PAD ON POLYCARBONATE GLIDE (RG):</b> The rubber bottomed glide is slip-resistant. It grips flooring, reduces movement, scratching and eliminates noise.

# specialty

Academic Task ..... 379

Industrial Clean Room ..... 390

Academic Arms + Casters ..... 401

Industrial Seating ..... 381

Industrial Anti-Microbial ..... 395

Industrial ESD ..... 386

Industrial Wipe Down ..... 398

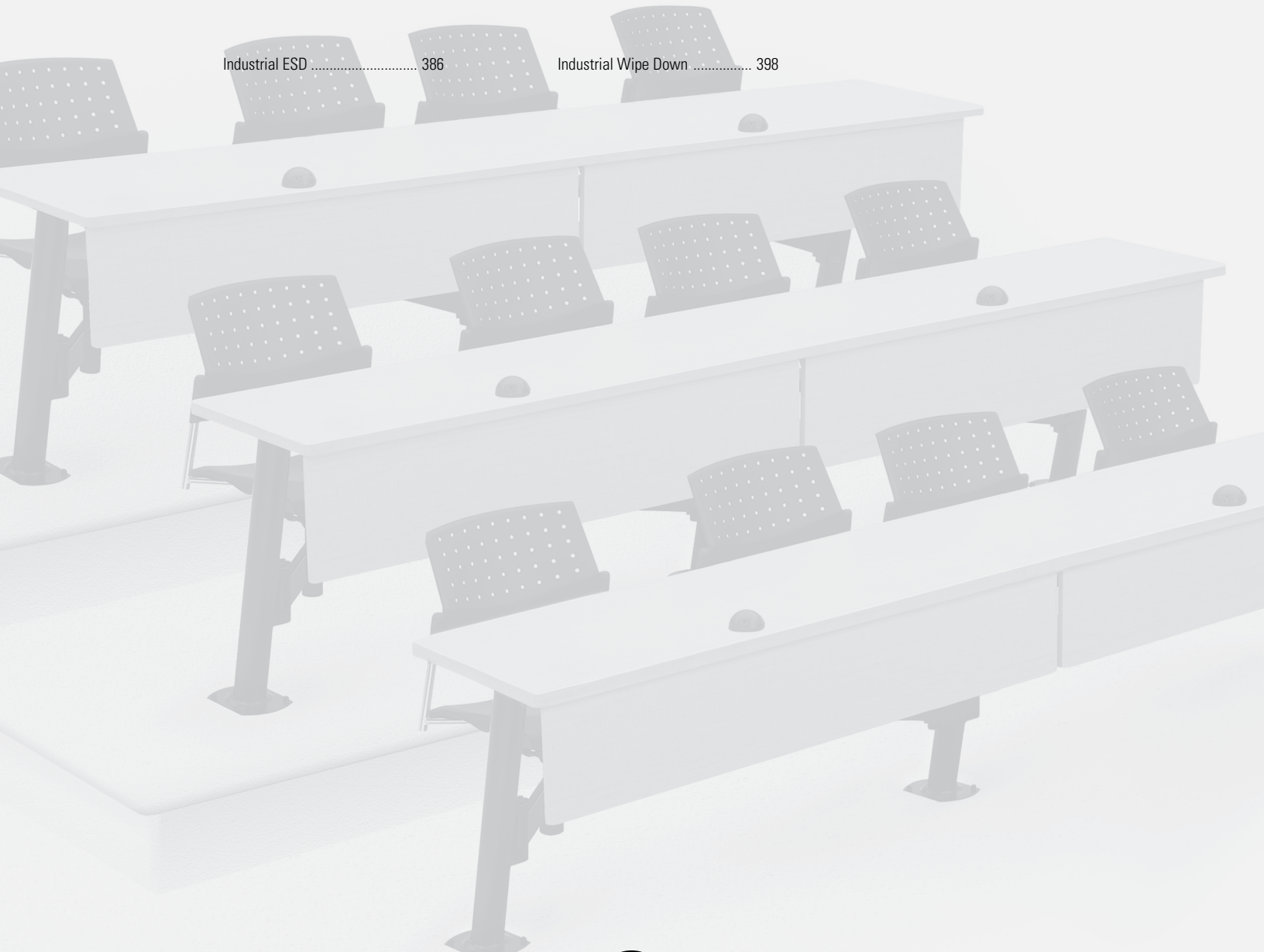

ACADEMIC TASK SEATING









model S2237-6 (3N) Goal

STANDARD FEATURES

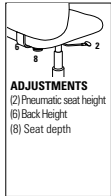
- Durable task seating designed to sustain years of use in educational and training room applications.
- The back bar is welded to the chair mechanism and the backrest is permanently fixed in height and angle.
- Standard with adjustable height T-arms with curved urethane armcaps (3N) in Black Only.
- All models are standard with a five-legged, injection molded base.
- Base and frame available in Black (BK) Only.
- C65 casters are standard.
- Vari-Width Adapter Plate (WA) (This is a Standard Feature for Granada models. An Option for Goal models. Add \$62. Available when chair is ordered with adjustable height arms. Allows each arm to move outward an additional 2" (for a total of 4" extra seat width) and locks with the use of an easy to maneuver lever.

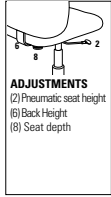
OPTIONAL FEATURES

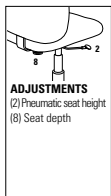
- See next page for additional arm options.
- Please see page 379 for additional caster options. Optional casters may be priced higher than the standard casters for your chair and the difference will be charged. Lower priced optional casters will not be credited.
- Vinyl Bumper Guard: This is a standard feature for Granada, Malaga, & Goal. As an option on ObusForme & Supra X. Add \$18. Available with back edge vinyl bumper guard option (VBG).
- Granada Models Only: Available in Memory Foam. Use code "MF". Add \$84.
- Granada Models Only: Black base with chrome footing. Specify "B3". Add \$88.

DESCRIPTION	FEATURES	MODEL#	STANDARD TEXTILE GRADES											
			1	2	3	4	5	6	7	8	9	10	11	12
 <p><b>LB Task w/3N Arms</b> COM Yardage: 1.50 Freight Class: 150 Product Weight (lbs.): 38 Cubic Feet Per Carton: 9</p>	 <p><b>ADJUSTMENTS</b> (2) Pneumatic seat height (6) Back Height (8) Seat depth</p> <p><b>Goal</b></p> <p>Ergonomic Features: C, H, N</p>	<b>S2237-6</b>	468	509	540	589	652	678	738	849	903	1005	1147	1324
			<b>OVERALL DIMENSIONS</b>			<b>SEAT DIMENSIONS</b>			<b>BACK DIMENSIONS</b>					
			W	D	H	W	D	H	W	H				
	24	23.5	37.5	20.5	17	16-21	18.5	19						
									<b>RTA 2</b>					
 <p><b>LB Task Armless</b> COM Yardage: 1.50 Freight Class: 250 Product Weight (lbs.): 35 Cubic Feet Per Carton: 9</p>	 <p><b>ADJUSTMENTS</b> (2) Pneumatic seat height (6) Back Height (8) Seat depth</p> <p><b>Goal</b></p> <p>Ergonomic Features: C, H, N</p>	<b>S2239-6</b>	371	412	443	490	558	580	641	752	805	909	1050	1228
			<b>OVERALL DIMENSIONS</b>			<b>SEAT DIMENSIONS</b>			<b>BACK DIMENSIONS</b>					
			W	D	H	W	D	H	W	H				
	20	23.5	37.5	20.5	17	16-21	18.5	19						
									<b>RTA 2</b>					
 <p><b>LB Task Chair Armless/Plain Back</b> COM Yardage: 1.50 Freight Class: 250 Product Weight (lbs.): 34 Cubic Feet Per Carton: 9.75</p>	 <p><b>ADJUSTMENTS</b> (2) Pneumatic seat height (8) Seat depth</p> <p><b>Granada</b></p> <p>Ergonomic Features: C, M, N</p>	<b>S3254</b>	544	588	617	665	731	755	815	926	979	1083	1226	1401
			<b>OVERALL DIMENSIONS</b>			<b>SEAT DIMENSIONS</b>			<b>BACK DIMENSIONS</b>					
			W	D	H	W	D	H	W	H				
	20.5	24.5	38	20.5	18.5	16.5-21.5	19	18.5						
									<b>RTA 2</b>					



**EXPLANATION OF VARIOUS INDUSTRIAL APPLICATIONS**

This section presents only some of the possibilities that are available. Please contact your Sales Representative for additional information.



**50 - INDUSTRIAL**

Designed for heavier duty intensive environments such as those found in factories, assembly lines and dispatch offices. Seating features durable components including heavy gauge steel construction, chromed chip/corrosion/humidity resistant pneumatic lift cylinders and frames, heavy duty bases, weight activated interval safety casters for hard floors or encased levelling glides, wear resistant fabric or easy clean vinyl upholstery.



**52 - ELECTROSTATIC DISCHARGE (ESD)**

ESD seating is designed to assist in the protection of delicate electronic equipment from the discharge of static electricity. All components of these chairs are designed and manufactured using conductive materials including: special fabric, bases, "lightning bolt" casters, mechanisms, pneumatic lifts and footrings. ESD seating is designed to be used in conjunction with personal wrist straps and ESD controlled floorings or ESD mats. All ESD seating products are tested to and meet the requirements of the ESD Association Standard Test Method ESD STM 12.1 - 1997 Section 5.3.



**56 - CLEAN ROOM (CLASS UL #1000)**

Class 1000 is the least intensive Clean Room classification used by hospital equipment suppliers and photo finishing/film companies. Workers here usually wear shop coats and gloves. Vinyl applied to the underside of the seat and vinyl or fabric upholstery are designed to prevent dust and other contaminants from entering the environment.



**62 - ANTI-MICROBIAL**

For hospital areas and labs that require furniture that minimizes bacterial and fungal growth and wipes up easily. Anti-microbial seating inhibits micro organism invasion and growth. Integrated filters allow fabric/vinyl to breath. A Class 1000 cleanroom would not contain more than 1000 particles bigger than half a micron in a cubic foot of air.



**64 - WIPE DOWN**

Furniture designed for dry food manufacturers, hospitals and forensic labs requiring regular and immediate clean up of dust,dirt or powder. Upholstery of any kind is unacceptable here. Features include comfortable Black self-skinned polyurethane seats and backs, chip/corroionn/humidity resistant pneumatic lift cylinders and frames,safety casters or glides. Some "Wipe Down" products may also be available with ESD.

**FABRIC APPLICATION GRID**

APPLICATION	FABRIC/VINYL
<b>50 - Industrial</b>	<b>Grade 2 (fabric):</b> Crescent, Imprint, Match, Renewal, Replay, Silhouette <b>Grade 3 (fabric):</b> Couture <b>Grade 3 (vinyl):</b> Allante FRee, Generations Collection
<b>52 - Electrostatic Discharge (ESD)</b>	<b>Grade 3 (fabric):</b> Gibraltar - GE46 Sapphire, GE91 Onyx <b>Grade 5 (vinyl):</b> ESO1 Blue
<b>56 - Clean Room (Class UL #1000)</b>	<b>Grade 3 (vinyl):</b> Generations Collection
<b>62 - Anti-Microbial with Global UltraSeal™</b>	<b>Grade 4 (vinyl):</b> Generations Collection (Arc, Aristo, Flair, Luxe, Surge, Verve, Vitality)

INDUSTRIAL SEATING



model 3212-50 (3N)

model 3288-50 (3N)

\* Images shown are for illustration purposes only.



**50 - Industrial**  
Designed for heavy duty environments found in factories, assembly lines and dispatch offices. See page 321 for available fabrics.

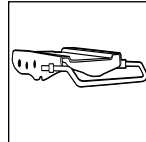

**Multi-Depth Mechanism**  
Standard on Granada models. Allows seat to move forward and backward over a 2" range with 5 locking positions to provide a more shallow or deeper seat.

STANDARD FEATURES

- \*Industrial models have a chrome back upright.
- Granada models feature a molded seat and contoured back with enhanced lumbar support.
- Standard with adjustable height T-arms with curved urethane armcaps (3N) in Black Only.
- Chrome chip/corrosion/humidity resistant pneumatic lift cylinders and frames.
- Chairs have a 5" chrome pneumatic cylinder, stools have a 10" chrome pneumatic cylinder.
- All chairs and stools have chrome back uprights.
- Clear protective back bumper (full surround) is standard on all models.
- Standard with a five-legged, heavy duty molded base in Black.
- C10R casters are standard on Granada models and Minotaur stools.
- Minotaur models are standard with a five-legged, heavy duty base with metal hub and C7R casters.
- Heavy Duty Bench Stools are standard with non-slip rubber glides.

OPTIONAL FEATURES

- See back of this section for additional arm or caster options.
- Optional casters may be priced higher than the standard casters for your chair and the difference will be charged. Lower priced optional casters will not be credited.
- See Textile and Finishes section of the pricebook for available Fabrics and Vinyls in grades 2-5.

DESCRIPTION FEATURES MODEL# STANDARD TEXTILE GRADES



**LB Multi-Tilter**  
COM Yardage: 1.50  
Freight Class: 150  
Product Weight (lbs.): 52  
Cubic Feet Per Carton: 13

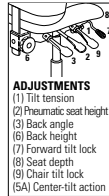

**Granada**  
  
Ergonomic Features:  
A, B, C, D, E, F, G, H, M, N, Q, S

	1	2	3	4	5	6	7	8	9	10	11	12
<b>3212-50</b>	-	1331	1362	1409	1478	-	-	-	-	-	-	-

OVERALL DIMENSIONS			SEAT DIMENSIONS			BACK DIMENSIONS		
W	D	H	W	D	H	W	H	
25.5	24	40	20.5	17-19.5	18-23	19	17.5-21.5	

RTA 2



**HB Multi-Tilter**  
COM Yardage: 1.75  
Freight Class: 250  
Product Weight (lbs.): 55  
Cubic Feet Per Carton: 14.75

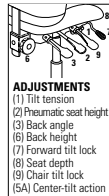

**Granada**  
  
Ergonomic Features:  
A, B, C, D, E, F, G, H, M, N, Q, S

	1	2	3	4	5	6	7	8	9	10	11	12
<b>3217-50</b>	-	1373	1417	1480	1569	-	-	-	-	-	-	-

OVERALL DIMENSIONS			SEAT DIMENSIONS			BACK DIMENSIONS		
W	D	H	W	D	H	W	H	
25.5	24.5	43	20.5	17-19.5	18-23	19	21.5-25.5	

RTA 2



**LB Task - Armless**  
COM Yardage: 1.50  
Freight Class: 250  
Product Weight (lbs.): 32  
Cubic Feet Per Carton: 13

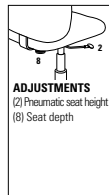







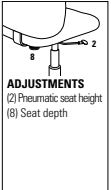

**Granada**  
  
Ergonomic Features:  
C, E, M, N

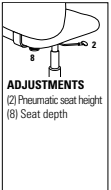
	1	2	3	4	5	6	7	8	9	10	11	12
<b>3254-50</b>	-	923	955	1003	1072	-	-	-	-	-	-	-

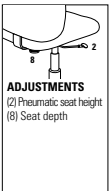
OVERALL DIMENSIONS			SEAT DIMENSIONS			BACK DIMENSIONS		
W	D	H	W	D	H	W	H	
20.5	24	38	20.5	17-19.5	17-22	19	19	

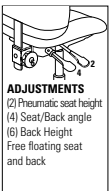
RTA 2

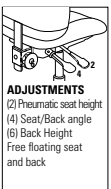
DESCRIPTION	FEATURES	MODEL#	STANDARD TEXTILE GRADES																														
			1	2	3	4	5	6	7	8	9	10	11	12																			
 <p><b>LB Task</b> - w/3N Arms COM Yardage: 1.50 Freight Class: 250 Product Weight (lbs.): 40 Cubic Feet Per Carton: 13</p>	 <p><b>ADJUSTMENTS</b> (2) Pneumatic seat height (8) Seat depth</p>	<p><b>Granada</b></p> <p>Ergonomic Features: C, E, M, N</p>	<table border="1"> <tr> <td>3255-50</td> <td>-</td> <td>1058</td> <td>1089</td> <td>1138</td> <td>1205</td> <td>-</td> <td>-</td> <td>-</td> <td>-</td> <td>-</td> <td>-</td> <td>-</td> <td>-</td> </tr> </table>												3255-50	-	1058	1089	1138	1205	-	-	-	-	-	-	-	-					
			3255-50	-	1058	1089	1138	1205	-	-	-	-	-	-	-	-																	
			<table border="1"> <tr> <th colspan="3">OVERALL DIMENSIONS</th> <th colspan="3">SEAT DIMENSIONS</th> <th colspan="3">BACK DIMENSIONS</th> </tr> <tr> <th>W</th> <th>D</th> <th>H</th> <th>W</th> <th>D</th> <th>H</th> <th>W</th> <th>H</th> </tr> <tr> <td>25.5</td> <td>24</td> <td>38</td> <td>20.5</td> <td>17-19.5</td> <td>17-22</td> <td>19</td> <td>19</td> </tr> </table>			OVERALL DIMENSIONS			SEAT DIMENSIONS			BACK DIMENSIONS			W	D	H	W	D	H	W	H	25.5	24	38	20.5	17-19.5	17-22	19	19	<p><b>RTA 2</b></p>		
			OVERALL DIMENSIONS			SEAT DIMENSIONS			BACK DIMENSIONS																								
W	D	H	W	D	H	W	H																										
25.5	24	38	20.5	17-19.5	17-22	19	19																										
 <p><b>Stool Task</b> - Armless COM Yardage: 1.50 Freight Class: 250 Product Weight (lbs.): 37 Cubic Feet Per Carton: 13</p>	 <p><b>ADJUSTMENTS</b> (2) Pneumatic seat height (8) Seat depth</p>	<p><b>Granada</b></p> <p>Ergonomic Features: C, E, M, N</p>	<table border="1"> <tr> <td>3256-50</td> <td>-</td> <td>1063</td> <td>1096</td> <td>1142</td> <td>1210</td> <td>-</td> <td>-</td> <td>-</td> <td>-</td> <td>-</td> <td>-</td> <td>-</td> <td>-</td> </tr> </table>												3256-50	-	1063	1096	1142	1210	-	-	-	-	-	-	-	-					
			3256-50	-	1063	1096	1142	1210	-	-	-	-	-	-	-	-																	
			<table border="1"> <tr> <th colspan="3">OVERALL DIMENSIONS</th> <th colspan="3">SEAT DIMENSIONS</th> <th colspan="3">BACK DIMENSIONS</th> </tr> <tr> <th>W</th> <th>D</th> <th>H</th> <th>W</th> <th>D</th> <th>H</th> <th>W</th> <th>H</th> </tr> <tr> <td>20.5</td> <td>24</td> <td>48</td> <td>20.5</td> <td>17.5-19</td> <td>24-34</td> <td>19</td> <td>19</td> </tr> </table>			OVERALL DIMENSIONS			SEAT DIMENSIONS			BACK DIMENSIONS			W	D	H	W	D	H	W	H	20.5	24	48	20.5	17.5-19	24-34	19	19	<p><b>RTA 2</b></p>		
			OVERALL DIMENSIONS			SEAT DIMENSIONS			BACK DIMENSIONS																								
W	D	H	W	D	H	W	H																										
20.5	24	48	20.5	17.5-19	24-34	19	19																										
 <p><b>Stool Task</b> - w/3N Arms COM Yardage: 1.50 Freight Class: 250 Product Weight (lbs.): 43 Cubic Feet Per Carton: 15.50</p>	 <p><b>ADJUSTMENTS</b> (2) Pneumatic seat height (8) Seat depth</p>	<p><b>Granada</b></p> <p>Ergonomic Features: C, E, H, M, N, Q</p>	<table border="1"> <tr> <td>3257-50</td> <td>-</td> <td>1196</td> <td>1228</td> <td>1277</td> <td>1342</td> <td>-</td> <td>-</td> <td>-</td> <td>-</td> <td>-</td> <td>-</td> <td>-</td> <td>-</td> </tr> </table>												3257-50	-	1196	1228	1277	1342	-	-	-	-	-	-	-	-					
			3257-50	-	1196	1228	1277	1342	-	-	-	-	-	-	-	-																	
			<table border="1"> <tr> <th colspan="3">OVERALL DIMENSIONS</th> <th colspan="3">SEAT DIMENSIONS</th> <th colspan="3">BACK DIMENSIONS</th> </tr> <tr> <th>W</th> <th>D</th> <th>H</th> <th>W</th> <th>D</th> <th>H</th> <th>W</th> <th>H</th> </tr> <tr> <td>25.5</td> <td>24</td> <td>48</td> <td>20.5</td> <td>17.5-19</td> <td>24-34</td> <td>19</td> <td>19</td> </tr> </table>			OVERALL DIMENSIONS			SEAT DIMENSIONS			BACK DIMENSIONS			W	D	H	W	D	H	W	H	25.5	24	48	20.5	17.5-19	24-34	19	19	<p><b>RTA 2</b></p>		
			OVERALL DIMENSIONS			SEAT DIMENSIONS			BACK DIMENSIONS																								
W	D	H	W	D	H	W	H																										
25.5	24	48	20.5	17.5-19	24-34	19	19																										
 <p><b>Stool Operator</b> - Armless COM Yardage: 1.50 Freight Class: 250 Product Weight (lbs.): 44 Cubic Feet Per Carton: 13</p>	 <p><b>ADJUSTMENTS</b> (2) Pneumatic seat height (4) Seat/Back angle (6) Back Height Free floating seat and back</p>	<p><b>Granada</b></p> <p>Ergonomic Features: C, D, F, G, M, N</p>	<table border="1"> <tr> <td>3278-50</td> <td>-</td> <td>1277</td> <td>1307</td> <td>1354</td> <td>1424</td> <td>-</td> <td>-</td> <td>-</td> <td>-</td> <td>-</td> <td>-</td> <td>-</td> <td>-</td> </tr> </table>												3278-50	-	1277	1307	1354	1424	-	-	-	-	-	-	-	-					
			3278-50	-	1277	1307	1354	1424	-	-	-	-	-	-	-	-																	
			<table border="1"> <tr> <th colspan="3">OVERALL DIMENSIONS</th> <th colspan="3">SEAT DIMENSIONS</th> <th colspan="3">BACK DIMENSIONS</th> </tr> <tr> <th>W</th> <th>D</th> <th>H</th> <th>W</th> <th>D</th> <th>H</th> <th>W</th> <th>H</th> </tr> <tr> <td>20.5</td> <td>23.5</td> <td>48</td> <td>20.5</td> <td>17.5</td> <td>24-34</td> <td>19</td> <td>17.5-21</td> </tr> </table>			OVERALL DIMENSIONS			SEAT DIMENSIONS			BACK DIMENSIONS			W	D	H	W	D	H	W	H	20.5	23.5	48	20.5	17.5	24-34	19	17.5-21	<p><b>RTA 2</b></p>		
			OVERALL DIMENSIONS			SEAT DIMENSIONS			BACK DIMENSIONS																								
W	D	H	W	D	H	W	H																										
20.5	23.5	48	20.5	17.5	24-34	19	17.5-21																										
 <p><b>Stool Operator</b> - w/3N Arms COM Yardage: 1.50 Freight Class: 250 Product Weight (lbs.): 52 Cubic Feet Per Carton: 15.50</p>	 <p><b>ADJUSTMENTS</b> (2) Pneumatic seat height (4) Seat/Back angle (6) Back Height Free floating seat and back</p>	<p><b>Granada</b></p> <p>Ergonomic Features: C, D, F, G, H, M, N, Q</p>	<table border="1"> <tr> <td>3288-50</td> <td>-</td> <td>1407</td> <td>1439</td> <td>1486</td> <td>1554</td> <td>-</td> <td>-</td> <td>-</td> <td>-</td> <td>-</td> <td>-</td> <td>-</td> <td>-</td> </tr> </table>												3288-50	-	1407	1439	1486	1554	-	-	-	-	-	-	-	-					
			3288-50	-	1407	1439	1486	1554	-	-	-	-	-	-	-	-																	
			<table border="1"> <tr> <th colspan="3">OVERALL DIMENSIONS</th> <th colspan="3">SEAT DIMENSIONS</th> <th colspan="3">BACK DIMENSIONS</th> </tr> <tr> <th>W</th> <th>D</th> <th>H</th> <th>W</th> <th>D</th> <th>H</th> <th>W</th> <th>H</th> </tr> <tr> <td>25.5</td> <td>23.5</td> <td>48</td> <td>20.5</td> <td>17.5</td> <td>24-34</td> <td>19</td> <td>17.5-21</td> </tr> </table>			OVERALL DIMENSIONS			SEAT DIMENSIONS			BACK DIMENSIONS			W	D	H	W	D	H	W	H	25.5	23.5	48	20.5	17.5	24-34	19	17.5-21	<p><b>RTA 2</b></p>		
			OVERALL DIMENSIONS			SEAT DIMENSIONS			BACK DIMENSIONS																								
W	D	H	W	D	H	W	H																										
25.5	23.5	48	20.5	17.5	24-34	19	17.5-21																										



DESCRIPTION FEATURES MODEL# STANDARD TEXTILE GRADES

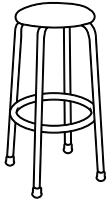

**Minotaur - Heavy Duty Work Stool**  
 COM Yardage: .75  
 Freight Class: 250  
 Product Weight (lbs.): 19  
 Cubic Feet Per Carton: 5.50

MODEL#	1	2	3	4	5	6	7	8	9	10	11	12
9632-50	-	412	429	452	484	-	-	-	-	-	-	-

OVERALL DIMENSIONS			SEAT DIMENSIONS			BACK DIMENSIONS	
W	D	H	W	D	H	W	H
16	16	32.5	14	-	32.5	-	-



**Minotaur - Work Stool Task**  
 COM Yardage: N/A  
 Freight Class: 250  
 Product Weight (lbs.): 26  
 Cubic Feet Per Carton: 13

5" Pneumatic

Ergonomic Features:  
 C, E

MODEL#	1	2	3	4	5	6	7	8	9	10	11	12
9662-50	798	-	-	-	-	-	-	-	-	-	-	-

OVERALL DIMENSIONS			SEAT DIMENSIONS			BACK DIMENSIONS	
W	D	H	W	D	H	W	H
18	21	32	18	16.5-19	14-19	16.5	16

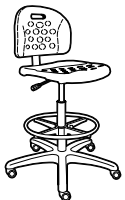

**Minotaur - Work Stool Task**  
 COM Yardage: N/A  
 Freight Class: 250  
 Product Weight (lbs.): 33  
 Cubic Feet Per Carton: 13

10" Pneumatic

Ergonomic Features:  
 C, E

MODEL#	1	2	3	4	5	6	7	8	9	10	11	12
9663-50	949	-	-	-	-	-	-	-	-	-	-	-

OVERALL DIMENSIONS			SEAT DIMENSIONS			BACK DIMENSIONS	
W	D	H	W	D	H	W	H
18	20.5	42	18	16.5-19	20-30	16.5	16.5



**Minotaur - Stool Posture Task**  
 COM Yardage: N/A  
 Freight Class: 250  
 Product Weight (lbs.): 30  
 Cubic Feet Per Carton: 13

5" Pneumatic

Ergonomic Features:  
 C, D

MODEL#	1	2	3	4	5	6	7	8	9	10	11	12
9664-50	899	-	-	-	-	-	-	-	-	-	-	-

OVERALL DIMENSIONS			SEAT DIMENSIONS			BACK DIMENSIONS	
W	D	H	W	D	H	W	H
18	20	31	18	16	14-19	16.5	12.5-19



**Minotaur - Stool Posture Task**  
 COM Yardage: N/A  
 Freight Class: 250  
 Product Weight (lbs.): 33  
 Cubic Feet Per Carton: 13

10" Pneumatic

Ergonomic Features:  
 C, D

MODEL#	1	2	3	4	5	6	7	8	9	10	11	12
9665-50	1049	-	-	-	-	-	-	-	-	-	-	-

OVERALL DIMENSIONS			SEAT DIMENSIONS			BACK DIMENSIONS	
W	D	H	W	D	H	W	H
18	20	39	39	16	20.5-30.5	16.5	12.5-19

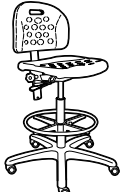

DESCRIPTION	FEATURES	MODEL#	STANDARD TEXTILE GRADES												
			1	2	3	4	5	6	7	8	9	10	11	12	
 <p><b>Minotaur - Stool Operator</b> COM Yardage: N/A Freight Class: 250 Product Weight (lbs.): 34 Cubic Feet Per Carton: 13</p>	5" Pneumatic  Ergonomic Features: C, D, F, G	9666-50	1038	-	-	-	-	-	-	-	-	-	-	-	
		<b>OVERALL DIMENSIONS</b> W    D    H			<b>SEAT DIMENSIONS</b> W    D    H			<b>BACK DIMENSIONS</b> W    H							
		18	20.5	32	18	17	15-20	16.5	12.5-19						
		<b>RTA 2</b>													
 <p><b>Minotaur - Stool Operator</b> COM Yardage: N/A Freight Class: 250 Product Weight (lbs.): 35 Cubic Feet Per Carton: 13</p>	10" Pneumatic  Ergonomic Features: C, D, F, G	9667-50	1190	-	-	-	-	-	-	-	-	-	-		
		<b>OVERALL DIMENSIONS</b> W    D    H			<b>SEAT DIMENSIONS</b> W    D    H			<b>BACK DIMENSIONS</b> W    H							
		18	20.5	42	18	17	21-31	16.5	12.5-19						
		<b>RTA 2</b>													

ESD SEATING



model 3256-52



model 9667-52 (C42)



**52 - Electrostatic Discharge (ESD)**

Designed to direct static electricity away from delicate equipment, electronic components or volatile chemicals.

\* Images shown are for illustration purposes only.

STANDARD FEATURES

- \*ESD models have a polished aluminum base.
- Use of an ESD chair does not guarantee the dissipation of static electricity. Other products (that may include an ESD chair mat, etc.) as part of an ESD design or system may be necessary depending on the specific situation.
- Granada models feature a molded seat and contoured back with enhanced lumbar support.
- Granada models are standard with fixed height T-arms with upholstered kidney shaped armcaps (Z2), in Chrome.
- No other conductive arms are available.
- Chrome chip/corrosion/humidity resistant pneumatic lift cylinders and frames.
- Chairs have a 5" chrome pneumatic cylinder, stools have a 10" chrome pneumatic cylinder.
- All chairs and stools have chrome back uprights and frames.
- Clear protective back bumper (full surround) is standard on all models.

- Standard with a five-legged, polished aluminum base.
- C38R casters are standard. These casters are suitable for hard surface flooring. Not Available on models 9601-52 and 9604-52.
- For models 9601-52 and 9604-52 a polished aluminum base with C42 ESD Glides are standard.
- All Work Stools and Heavy Duty Bench Stools have chrome frames.
- Work stools are shipped fully set-up.

OPTIONAL FEATURES

- See back of this section for additional arm or caster options.
- Optional casters may be priced higher than the standard casters for your chair and the difference will be charged. Lower priced optional casters will not be credited.
- See Textile and Finishes section of the price book for available Fabrics and Vinyls in grades 3-5.

DESCRIPTION FEATURES MODEL# STANDARD TEXTILE GRADES



**LB Multi-Tilter**  
COM Yardage: 1.50  
Freight Class: 250  
Product Weight (lbs.): 250  
Cubic Feet Per Carton: 13

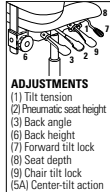

**Granada**  
  
Ergonomic Features:  
A, B, C, D, E, F, G, H, M, N, Q, S

MODEL#	STANDARD TEXTILE GRADES											
	1	2	3	4	5	6	7	8	9	10	11	12
3212-52	-	-	1532	-	1646	-	-	-	-	-	-	-
OVERALL DIMENSIONS			SEAT DIMENSIONS			BACK DIMENSIONS						
W	D	H	W	D	H	W	H					
26.5	24	40	20.5	17-19.5	18-23	19	17.5-21.5					

RTA 2



**HB Multi-Tilter**  
COM Yardage: 1.75  
Freight Class: 150  
Product Weight (lbs.): 57  
Cubic Feet Per Carton: 13

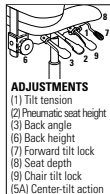

**Granada**  
  
Ergonomic Features:  
A, B, C, D, E, F, G, H, M, N, Q, S

MODEL#	STANDARD TEXTILE GRADES											
	1	2	3	4	5	6	7	8	9	10	11	12
3217-52	-	-	1576	-	1729	-	-	-	-	-	-	-
OVERALL DIMENSIONS			SEAT DIMENSIONS			BACK DIMENSIONS						
W	D	H	W	D	H	W	H					
26.5	24.5	43	20.5	17-19.5	18-23	19	21.5-25.5					

RTA 2





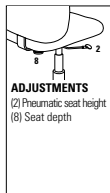





**LB Task - Armless**  
COM Yardage: 1.50  
Freight Class: 250  
Product Weight (lbs.): 34  
Cubic Feet Per Carton: 13

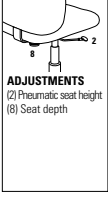

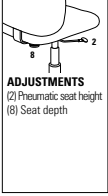

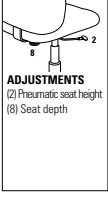

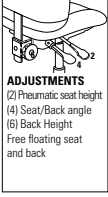
**Granada**  
  
Ergonomic Features:  
C, E, M, N

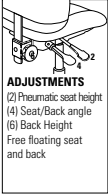

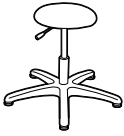
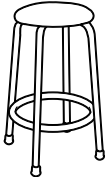

MODEL#	STANDARD TEXTILE GRADES											
	1	2	3	4	5	6	7	8	9	10	11	12
3254-52	-	-	1124	-	1241	-	-	-	-	-	-	-
OVERALL DIMENSIONS			SEAT DIMENSIONS			BACK DIMENSIONS						
W	D	H	W	D	H	W	H					
20.5	24	38	20.5	17.5-19	17-22	19	19					

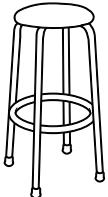
RTA 2

DESCRIPTION	FEATURES	MODEL#	STANDARD TEXTILE GRADES											
			1	2	3	4	5	6	7	8	9	10	11	12
 <b>LB Task</b> - w/2Z Arms COM Yardage: 1.50 Freight Class: 250 Product Weight (lbs.): 42 Cubic Feet Per Carton: 13	 <b>ADJUSTMENTS</b> (2) Pneumatic seat height (8) Seat depth	<b>3255-52</b>	-	-	1259	-	1377	-	-	-	-	-	-	-
			<b>OVERALL DIMENSIONS</b>			<b>SEAT DIMENSIONS</b>			<b>BACK DIMENSIONS</b>					
			<b>W</b>	<b>D</b>	<b>H</b>	<b>W</b>	<b>D</b>	<b>H</b>	<b>W</b>	<b>H</b>				
			26.5	24	38	20.5	17.5-19	17-22	19	19				
	<b>Granada</b>	Ergonomic Features: C, E, M, N	<b>RTA 2</b>											
 <b>Stool Task</b> - Armless COM Yardage: 1.50 Freight Class: 250 Product Weight (lbs.): 39 Cubic Feet Per Carton: 13	 <b>ADJUSTMENTS</b> (2) Pneumatic seat height (8) Seat depth	<b>3256-52</b>	-	-	1264	-	1380	-	-	-	-	-	-	
			<b>OVERALL DIMENSIONS</b>			<b>SEAT DIMENSIONS</b>			<b>BACK DIMENSIONS</b>					
			<b>W</b>	<b>D</b>	<b>H</b>	<b>W</b>	<b>D</b>	<b>H</b>	<b>W</b>	<b>H</b>				
			20.5	24	48	20.5	17.5-19	24-34	19	19				
	<b>Granada</b>	Ergonomic Features: C, E, M, N	<b>RTA 2</b>											
 <b>Stool Task</b> COM Yardage: 1.50 Freight Class: 250 Product Weight (lbs.): 45 Cubic Feet Per Carton: 15.50	 <b>ADJUSTMENTS</b> (2) Pneumatic seat height (8) Seat depth	<b>3257-52</b>	-	-	1459	-	1575	-	-	-	-	-	-	
			<b>OVERALL DIMENSIONS</b>			<b>SEAT DIMENSIONS</b>			<b>BACK DIMENSIONS</b>					
			<b>W</b>	<b>D</b>	<b>H</b>	<b>W</b>	<b>D</b>	<b>H</b>	<b>W</b>	<b>H</b>				
			25.5	24	48	20.5	17.5-19	24-34	19	19				
	<b>Granada</b>	Ergonomic Features: C, E, H, M, N, Q	<b>RTA 2</b>											
 <b>Stool Operator</b> - Armless COM Yardage: 1.50 Freight Class: 250 Product Weight (lbs.): 46 Cubic Feet Per Carton: 13	 <b>ADJUSTMENTS</b> (2) Pneumatic seat height (4) Seat/Back angle (6) Back Height Free floating seat and back	<b>3278-52</b>	-	-	1478	-	1593	-	-	-	-	-	-	
			<b>OVERALL DIMENSIONS</b>			<b>SEAT DIMENSIONS</b>			<b>BACK DIMENSIONS</b>					
			<b>W</b>	<b>D</b>	<b>H</b>	<b>W</b>	<b>D</b>	<b>H</b>	<b>W</b>	<b>H</b>				
			20.5	23.5	48	20.5	17.5	24-34	19	17.5-21.5				
	<b>Granada</b>	Ergonomic Features: C, D, F, G, M, N	<b>RTA 2</b>											
 <b>Stool Operator</b> COM Yardage: 1.50 Freight Class: 250 Product Weight (lbs.): 54 Cubic Feet Per Carton: 15.50	 <b>ADJUSTMENTS</b> (2) Pneumatic seat height (4) Seat/Back angle (6) Back Height Free floating seat and back	<b>3288-52</b>	-	-	1609	-	1723	-	-	-	-	-	-	
			<b>OVERALL DIMENSIONS</b>			<b>SEAT DIMENSIONS</b>			<b>BACK DIMENSIONS</b>					
			<b>W</b>	<b>D</b>	<b>H</b>	<b>W</b>	<b>D</b>	<b>H</b>	<b>W</b>	<b>H</b>				
			26.5	23.5	48	20.5	17.5	24-34	19	17.5-21.5				
	<b>Granada</b>	Ergonomic Features: C, D, F, G, H, M, N, Q	<b>RTA 2</b>											

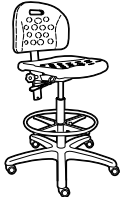

DESCRIPTION	FEATURES	MODEL#	STANDARD TEXTILE GRADES											
			1	2	3	4	5	6	7	8	9	10	11	12
 <p><b>Minotaur - Work Stool</b> COM Yardage: .75 Freight Class: 250 Product Weight (lbs.): 14 Cubic Feet Per Carton: 6.75</p>	5" Pneumatic  Ergonomic Features: C	9602-52	646	-	-	-	-	-	-	-	-	-	-	-
			OVERALL DIMENSIONS			SEAT DIMENSIONS			BACK DIMENSIONS					
			W	D	H	W	D	H	W	H				
			14	14	17.5	14	-	15-20	-	-				
			RTA 00											
 <p><b>Minotaur - Work Stool</b> COM Yardage: .75 Freight Class: 300 Product Weight (lbs.): 16 Cubic Feet Per Carton: 13</p>	10" Pneumatic  Ergonomic Features: C	9604-52	697	-	-	-	-	-	-	-	-	-	-	
			OVERALL DIMENSIONS			SEAT DIMENSIONS			BACK DIMENSIONS					
			W	D	H	W	D	H	W	H				
			14	14	26.5	14	-	21.5-31.5	-	-				
			RTA 00											
 <p><b>Minotaur - Heavy Duty Work Stool</b> COM Yardage: .75 Freight Class: 250 Product Weight (lbs.): 17 Cubic Feet Per Carton: 5.50</p>		9624-52	562	-	-	-	-	-	-	-	-	-	-	
			OVERALL DIMENSIONS			SEAT DIMENSIONS			BACK DIMENSIONS					
			W	D	H	W	D	H	W	H				
			16	16	27.5	14	-	27.5	-	-				
			RTA 00 											
 <p><b>Minotaur - Heavy Duty Work Stool</b> COM Yardage: .75 Freight Class: 250 Product Weight (lbs.): 19 Cubic Feet Per Carton: 5.50</p>		9632-52	580	-	-	-	-	-	-	-	-	-	-	
			OVERALL DIMENSIONS			SEAT DIMENSIONS			BACK DIMENSIONS					
			W	D	H	W	D	H	W	H				
			16	16	32.5	14	-	32.5	-	-				
			RTA 00 											
 <p><b>Minotaur - Work Stool Task</b> COM Yardage: N/A Freight Class: 250 Product Weight (lbs.): 26 Cubic Feet Per Carton: 13</p>	5" Pneumatic  Ergonomic Features: C, E	9662-52	977	-	-	-	-	-	-	-	-	-	-	
			OVERALL DIMENSIONS			SEAT DIMENSIONS			BACK DIMENSIONS					
			W	D	H	W	D	H	W	H				
			18	21	32	18	16.5-19	14-19	16.5	16				
			RTA 2											

DESCRIPTION	FEATURES	MODEL#	STANDARD TEXTILE GRADES												
			1	2	3	4	5	6	7	8	9	10	11	12	
 <p><b>Minotaur - Work Stool Task</b> COM Yardage: N/A Freight Class: 250 Product Weight (lbs.): 33 Cubic Feet Per Carton: 13</p>	10" Pneumatic  Ergonomic Features: C, E	9663-52	1130	-	-	-	-	-	-	-	-	-	-	-	
		<b>OVERALL DIMENSIONS</b>			<b>SEAT DIMENSIONS</b>			<b>BACK DIMENSIONS</b>							
		<b>W</b>	<b>D</b>	<b>H</b>	<b>W</b>	<b>D</b>	<b>H</b>	<b>W</b>	<b>H</b>						
		18	20.5	42	18	16.5-19	20-30	16.5	16.5						
				<b>RTA 2</b>											
 <p><b>Minotaur - Stool Posture Task</b> COM Yardage: N/A Freight Class: 250 Product Weight (lbs.): 30 Cubic Feet Per Carton: 13</p>	5" Pneumatic  Ergonomic Features: C, D	9664-52	1079	-	-	-	-	-	-	-	-	-	-	-	
		<b>OVERALL DIMENSIONS</b>			<b>SEAT DIMENSIONS</b>			<b>BACK DIMENSIONS</b>							
		<b>W</b>	<b>D</b>	<b>H</b>	<b>W</b>	<b>D</b>	<b>H</b>	<b>W</b>	<b>H</b>						
		18	20	31	18	16	14-19	16.5	12.5-19						
				<b>RTA 2</b>											
 <p><b>Minotaur - Stool Posture Task</b> COM Yardage: N/A Freight Class: 250 Product Weight (lbs.): 33 Cubic Feet Per Carton: 13</p>	10" Pneumatic  Ergonomic Features: C, D	9665-52	1230	-	-	-	-	-	-	-	-	-	-	-	
		<b>OVERALL DIMENSIONS</b>			<b>SEAT DIMENSIONS</b>			<b>BACK DIMENSIONS</b>							
		<b>W</b>	<b>D</b>	<b>H</b>	<b>W</b>	<b>D</b>	<b>H</b>	<b>W</b>	<b>H</b>						
		18	20	39	39	16	20.5-30.5	16.5	12.5-19						
				<b>RTA 2</b>											
 <p><b>Minotaur - Stool Operator</b> COM Yardage: N/A Freight Class: 250 Product Weight (lbs.): 34 Cubic Feet Per Carton: 13</p>	5" Pneumatic  Ergonomic Features: C, D, F, G	9666-52	1221	-	-	-	-	-	-	-	-	-	-	-	
		<b>OVERALL DIMENSIONS</b>			<b>SEAT DIMENSIONS</b>			<b>BACK DIMENSIONS</b>							
		<b>W</b>	<b>D</b>	<b>H</b>	<b>W</b>	<b>D</b>	<b>H</b>	<b>W</b>	<b>H</b>						
		18	20.5	32	18	17	15-20	16.5	12.5-19						
				<b>RTA 2</b>											
 <p><b>Minotaur - Stool Operator</b> COM Yardage: N/A Freight Class: 250 Product Weight (lbs.): 35 Cubic Feet Per Carton: 13</p>	10" Pneumatic  Ergonomic Features: C, D, F, G	9667-52	1372	-	-	-	-	-	-	-	-	-	-	-	
		<b>OVERALL DIMENSIONS</b>			<b>SEAT DIMENSIONS</b>			<b>BACK DIMENSIONS</b>							
		<b>W</b>	<b>D</b>	<b>H</b>	<b>W</b>	<b>D</b>	<b>H</b>	<b>W</b>	<b>H</b>						
		18	20.5	42	18	17	21-31	16.5	12.5-19						
				<b>RTA 2</b>											

CLEAN ROOM CLASS #1000 - SEATING



model 3212-56 (3N)



model 9666-56



**56 - Clean Room Class #1000**

Vinyl applied to the underside of the seat and vinyl or fabric upholstery are designed to prevent dust and other contaminants from entering the environment.

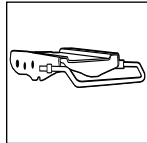

**Multi-Depth Mechanism**  
Standard on Granada models. Allows seat to move forward and backward over a 2" range with 5 locking positions to provide a more shallow or deeper seat.

\* Images shown are for illustration purposes only.

STANDARD FEATURES

- \*Clean Room Class #1000 models have a black cylinder.
- Granada models feature a molded seat and contoured back with enhanced lumbar support.
- Granada models are standard with adjustable height T-arms with curved urethane armcaps (3N) in Black Only. See page 346 for additional arm options.
- Chairs have a 5" black pneumatic cylinder, stools have a 10" black pneumatic cylinder.
- All chairs and stools have black back uprights and frames.
- Clear protective back bumper (full surround) is standard on all models.
- Standard with a five-legged, injection molded base in Black.
- C10R** casters are standard on Granada and Minotaur Stools.
- C65R** casters are standard on Minotaur Work Stools.
- All Bench Stools have chrome frames.
- Work Stools are shipped fully set-up.

OPTIONAL FEATURES

- See back of this section for additional arm or caster options.
- Optional casters may be priced higher than the standard casters for your chair and the difference will be charged. Lower priced optional casters will not be credited.
- All Clean Room models are only available in grade 2 vinyls. See Textile and Finishes section of the price book .

DESCRIPTION FEATURES MODEL# STANDARD TEXTILE GRADES



**LB Multi-Tilter**  
COM Yardage: 1.50  
Freight Class: 150  
Product Weight (lbs.): 52  
Cubic Feet Per Carton: 13

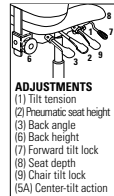

**Granada**  
  
Ergonomic Features:  
A, B, C, D, E, F, G, H, M, N, Q, S

MODEL#	STANDARD TEXTILE GRADES											
	1	2	3	4	5	6	7	8	9	10	11	12
3212-56	-	1250	-	-	-	-	-	-	-	-	-	-
OVERALL DIMENSIONS			SEAT DIMENSIONS			BACK DIMENSIONS						
W	D	H	W	D	H	W	H					
52	24	40	20.5	17-19.5	18-23	19	17.5-21.5					

RTA 2



**HB Multi-Tilter**  
COM Yardage: 1.75  
Freight Class: 250  
Product Weight (lbs.): 55  
Cubic Feet Per Carton: 14.75

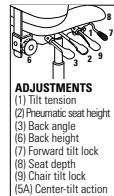

**Granada**  
  
Ergonomic Features:  
A, B, C, D, E, F, G, H, M, N, Q, S

MODEL#	STANDARD TEXTILE GRADES											
	1	2	3	4	5	6	7	8	9	10	11	12
3217-56	-	1291	-	-	-	-	-	-	-	-	-	-
OVERALL DIMENSIONS			SEAT DIMENSIONS			BACK DIMENSIONS						
W	D	H	W	D	H	W	H					
25.5	24.5	43	20.5	17-19.5	18-23	19	21.5-25.5					

RTA 2





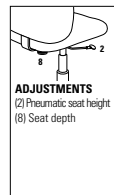



**LB Task - Armless**  
COM Yardage: 1.50  
Freight Class: 250  
Product Weight (lbs.): 40  
Cubic Feet Per Carton: 13



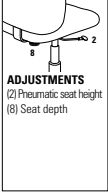

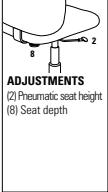

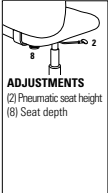
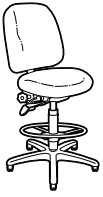
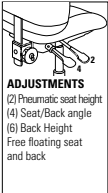
**Granada**  
  
Ergonomic Features:  
C, E, M, N

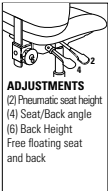
MODEL#	STANDARD TEXTILE GRADES											
	1	2	3	4	5	6	7	8	9	10	11	12
3254-56	-	845	-	-	-	-	-	-	-	-	-	-
OVERALL DIMENSIONS			SEAT DIMENSIONS			BACK DIMENSIONS						
W	D	H	W	D	H	W	H					
20.5	24	38	20.5	17.5-19	17-22	19	19					

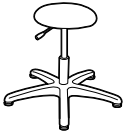
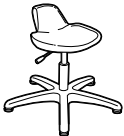
RTA 2

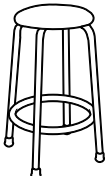
DESCRIPTION	FEATURES	MODEL#	STANDARD TEXTILE GRADES											
			1	2	3	4	5	6	7	8	9	10	11	12
 <b>LB Task</b> - w/3N Arms COM Yardage: 1.50 Freight Class: 250 Product Weight (lbs.): 40 Cubic Feet Per Carton: 13	 <b>ADJUSTMENTS</b> (2) Pneumatic seat height (8) Seat depth	<b>3255-56</b>	-	887	-	-	-	-	-	-	-	-	-	-
			<b>OVERALL DIMENSIONS</b>			<b>SEAT DIMENSIONS</b>			<b>BACK DIMENSIONS</b>					
			<b>W</b>	<b>D</b>	<b>H</b>	<b>W</b>	<b>D</b>	<b>H</b>	<b>W</b>	<b>H</b>				
			25.5	24	38	20.5	17.5-19	17-22	19	19				
	<b>Granada</b>	Ergonomic Features: C, E, M, N	<b>RTA 2</b>											
 <b>Stool Task</b> - Armless COM Yardage: 1.50 Freight Class: 250 Product Weight (lbs.): 37 Cubic Feet Per Carton: 13	 <b>ADJUSTMENTS</b> (2) Pneumatic seat height (8) Seat depth	<b>3256-56</b>	-	981	-	-	-	-	-	-	-	-	-	-
			<b>OVERALL DIMENSIONS</b>			<b>SEAT DIMENSIONS</b>			<b>BACK DIMENSIONS</b>					
			<b>W</b>	<b>D</b>	<b>H</b>	<b>W</b>	<b>D</b>	<b>H</b>	<b>W</b>	<b>H</b>				
			20.5	24	48	20.5	17.5-19	24-34	19	19				
	<b>Granada</b>	Ergonomic Features: C, E, M, N	<b>RTA 2</b>											
 <b>Stool Task</b> - w/3N Arms COM Yardage: 1.50 Freight Class: 250 Product Weight (lbs.): 43 Cubic Feet Per Carton: 15.50	 <b>ADJUSTMENTS</b> (2) Pneumatic seat height (8) Seat depth	<b>3257-56</b>	-	1115	-	-	-	-	-	-	-	-	-	-
			<b>OVERALL DIMENSIONS</b>			<b>SEAT DIMENSIONS</b>			<b>BACK DIMENSIONS</b>					
			<b>W</b>	<b>D</b>	<b>H</b>	<b>W</b>	<b>D</b>	<b>H</b>	<b>W</b>	<b>H</b>				
			25.5	24	48	20.5	17.5-19	24-34	19	19				
	<b>Granada</b>	Ergonomic Features: C, E, H, M, N, Q	<b>RTA 2</b>											
 <b>Stool Operator</b> - Armless COM Yardage: 1.50 Freight Class: 250 Product Weight (lbs.): 44 Cubic Feet Per Carton: 13	 <b>ADJUSTMENTS</b> (2) Pneumatic seat height (4) Seat/Back angle (6) Back Height Free floating seat and back	<b>3278-56</b>	-	1195	-	-	-	-	-	-	-	-	-	-
			<b>OVERALL DIMENSIONS</b>			<b>SEAT DIMENSIONS</b>			<b>BACK DIMENSIONS</b>					
			<b>W</b>	<b>D</b>	<b>H</b>	<b>W</b>	<b>D</b>	<b>H</b>	<b>W</b>	<b>H</b>				
			20.5	23.5	48	20.5	17.5	24-34	19	17.5-21.5				
	<b>Granada</b>	Ergonomic Features: C, D, F, G, M, N	<b>RTA 2</b>											
 <b>Stool Operator</b> - w/3N Arms COM Yardage: 1.50 Freight Class: 250 Product Weight (lbs.): 52 Cubic Feet Per Carton: 15.50	 <b>ADJUSTMENTS</b> (2) Pneumatic seat height (4) Seat/Back angle (6) Back Height Free floating seat and back	<b>3288-56</b>	-	1326	-	-	-	-	-	-	-	-	-	-
			<b>OVERALL DIMENSIONS</b>			<b>SEAT DIMENSIONS</b>			<b>BACK DIMENSIONS</b>					
			<b>W</b>	<b>D</b>	<b>H</b>	<b>W</b>	<b>D</b>	<b>H</b>	<b>W</b>	<b>H</b>				
			25.5	23.5	48	20.5	17.5	24-34	19	17.5-21.5				
	<b>Granada</b>	Ergonomic Features: C, D, F, G, H, M, N, Q	<b>RTA 2</b>											

DESCRIPTION	FEATURES	MODEL#	STANDARD TEXTILE GRADES													
			1	2	3	4	5	6	7	8	9	10	11	12		
 <p><b>Minotaur - Work Stool</b> COM Yardage: .75 Freight Class: 250 Product Weight (lbs.): 14 Cubic Feet Per Carton: 6.50</p>	5" Pneumatic  Ergonomic Features: C	9602-56	-	574	-	-	-	-	-	-	-	-	-	-		
		<b>OVERALL DIMENSIONS</b>			<b>SEAT DIMENSIONS</b>			<b>BACK DIMENSIONS</b>								
		<b>W</b>	<b>D</b>	<b>H</b>	<b>W</b>	<b>D</b>	<b>H</b>	<b>W</b>	<b>H</b>							
			14	14	17.5	14	-	15-20	-	-						
			<b>RTA 00</b>													
 <p><b>Minotaur - Work Stool</b> COM Yardage: .75 Freight Class: 250 Product Weight (lbs.): 16 Cubic Feet Per Carton: 6.50</p>	10" Pneumatic  Ergonomic Features: C	9604-56	-	625	-	-	-	-	-	-	-	-	-	-		
		<b>OVERALL DIMENSIONS</b>			<b>SEAT DIMENSIONS</b>			<b>BACK DIMENSIONS</b>								
		<b>W</b>	<b>D</b>	<b>H</b>	<b>W</b>	<b>D</b>	<b>H</b>	<b>W</b>	<b>H</b>							
			14	14	26.5	14	-	21.5-31.5	-	-						
			<b>RTA 00</b>													
 <p><b>Minotaur - Work Stool</b> COM Yardage: N/A Freight Class: 250 Product Weight (lbs.): 16 Cubic Feet Per Carton: 6.50</p>	5" Pneumatic  Ergonomic Features: C	9611-56	605	-	-	-	-	-	-	-	-	-	-	-		
		<b>OVERALL DIMENSIONS</b>			<b>SEAT DIMENSIONS</b>			<b>BACK DIMENSIONS</b>								
		<b>W</b>	<b>D</b>	<b>H</b>	<b>W</b>	<b>D</b>	<b>H</b>	<b>W</b>	<b>H</b>							
			14	14	24.5	14	-	15-20	-	-						
			<b>RTA 00</b>													
 <p><b>Minotaur - Work Stool</b> COM Yardage: N/A Freight Class: 250 Product Weight (lbs.): 18 Cubic Feet Per Carton: 8.25</p>	10" Pneumatic  Ergonomic Features: C	9612-56	655	-	-	-	-	-	-	-	-	-	-	-		
		<b>OVERALL DIMENSIONS</b>			<b>SEAT DIMENSIONS</b>			<b>BACK DIMENSIONS</b>								
		<b>W</b>	<b>D</b>	<b>H</b>	<b>W</b>	<b>D</b>	<b>H</b>	<b>W</b>	<b>H</b>							
			14	14	31.	14	-	21.5-31.5	-	-						
			<b>RTA 00</b>													
 <p><b>Minotaur - Heavy Duty Work Stool</b> COM Yardage: .75 Freight Class: 250 Product Weight (lbs.): 17 Cubic Feet Per Carton: 5.50</p>		9624-56	-	503	-	-	-	-	-	-	-	-	-	-		
		<b>OVERALL DIMENSIONS</b>			<b>SEAT DIMENSIONS</b>			<b>BACK DIMENSIONS</b>								
		<b>W</b>	<b>D</b>	<b>H</b>	<b>W</b>	<b>D</b>	<b>H</b>	<b>W</b>	<b>H</b>							
			16	16	27.5	14	-	27.5	-	-						
			<b>RTA 00</b> 													

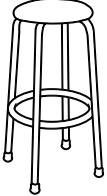

DESCRIPTION	FEATURES	MODEL#	STANDARD TEXTILE GRADES													
			1	2	3	4	5	6	7	8	9	10	11	12		
 <p><b>Minotaur - Heavy Duty Work Stool</b> COM Yardage: 0.75 Freight Class: 250 Product Weight (lbs.): 19 Cubic Feet Per Carton: 5.50</p>		9632-56	-	525	-	-	-	-	-	-	-	-	-	-	-	
			OVERALL DIMENSIONS			SEAT DIMENSIONS			BACK DIMENSIONS							
			W	D	H	W	D	H	W	H						
		16	16	32.5	14	-	32.5	-	-							
			RTA 00		Ups											

DESCRIPTION	FEATURES	MODEL#	STANDARD TEXTILE GRADES														
			1	2	3	4	5	6	7	8	9	10	11	12			
 <p><b>Minotaur - Work Stool Task</b> COM Yardage: N/A Freight Class: 250 Product Weight (lbs.): 26 Cubic Feet Per Carton: 13</p>	5" Pneumatic  Ergonomic Features: C, E	9662-56	706	-	-	-	-	-	-	-	-	-	-	-	-		
				OVERALL DIMENSIONS			SEAT DIMENSIONS			BACK DIMENSIONS							
				W	D	H	W	D	H	W	H						
		18	21	32	18	16.5-19	14-19	16.5	16								
			RTA 2														

DESCRIPTION	FEATURES	MODEL#	STANDARD TEXTILE GRADES														
			1	2	3	4	5	6	7	8	9	10	11	12			
 <p><b>Minotaur - Work Stool Task</b> COM Yardage: N/A Freight Class: 250 Product Weight (lbs.): 33 Cubic Feet Per Carton: 13</p>	10" Pneumatic  Ergonomic Features: C, E	9663-56	857	-	-	-	-	-	-	-	-	-	-	-	-		
				OVERALL DIMENSIONS			SEAT DIMENSIONS			BACK DIMENSIONS							
				W	D	H	W	D	H	W	H						
		18	20.5	42	18	16.5-19	20-30	16.5	16.5								
			RTA 2														

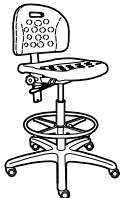
DESCRIPTION	FEATURES	MODEL#	STANDARD TEXTILE GRADES														
			1	2	3	4	5	6	7	8	9	10	11	12			
 <p><b>Minotaur - Stool Posture Task</b> COM Yardage: N/A Freight Class: 250 Product Weight (lbs.): 30 Cubic Feet Per Carton: 13</p>	5" Pneumatic  Ergonomic Features: C, D	9664-56	806	-	-	-	-	-	-	-	-	-	-	-	-		
				OVERALL DIMENSIONS			SEAT DIMENSIONS			BACK DIMENSIONS							
				W	D	H	W	D	H	W	H						
		18	20	31	18	16	14-19	16.5	12.5-19								
			RTA 2														

DESCRIPTION	FEATURES	MODEL#	STANDARD TEXTILE GRADES														
			1	2	3	4	5	6	7	8	9	10	11	12			
 <p><b>Minotaur - Stool Posture Task</b> COM Yardage: N/A Freight Class: 250 Product Weight (lbs.): 33 Cubic Feet Per Carton: 13</p>	10" Pneumatic  Ergonomic Features: C, D	9665-56	957	-	-	-	-	-	-	-	-	-	-	-	-		
				OVERALL DIMENSIONS			SEAT DIMENSIONS			BACK DIMENSIONS							
				W	D	H	W	D	H	W	H						
		18	20	39	39	16	20.5-30.5	16.5	12.5-19								
			RTA 2														

DESCRIPTION	FEATURES	MODEL#	STANDARD TEXTILE GRADES													
			1	2	3	4	5	6	7	8	9	10	11	12		
 <p><b>Minotaur - Stool Operator</b> COM Yardage: N/A Freight Class: 250 Product Weight (lbs.): 34 Cubic Feet Per Carton: 13</p>	5" Pneumatic  Ergonomic Features: C, D, F, G	<b>9666-56</b> 949	-	-	-	-	-	-	-	-	-	-	-			
			<b>OVERALL DIMENSIONS</b>			<b>SEAT DIMENSIONS</b>			<b>BACK DIMENSIONS</b>							
			<b>W</b>	<b>D</b>	<b>H</b>	<b>W</b>	<b>D</b>	<b>H</b>	<b>W</b>	<b>H</b>						
			18	20.5	18	18	17	15-20	16.5	12.5-19						
			<b>RTA 2</b>													
 <p><b>Minotaur - Stool Operator</b> COM Yardage: N/A Freight Class: 250 Product Weight (lbs.): 35 Cubic Feet Per Carton: 13</p>	10" Pneumatic  Ergonomic Features: C, D, F, G	<b>9667-56</b> 1100	-	-	-	-	-	-	-	-	-	-	-			
			<b>OVERALL DIMENSIONS</b>			<b>SEAT DIMENSIONS</b>			<b>BACK DIMENSIONS</b>							
			<b>W</b>	<b>D</b>	<b>H</b>	<b>W</b>	<b>D</b>	<b>H</b>	<b>W</b>	<b>H</b>						
			18	20.5	42	18	17	21-31	16.5	12.5-19						
			<b>RTA 2</b>													

ANTI-MICROBIAL - SEATING



model 3212-62 (3N)

\* Images shown are for illustration purposes only.



**62 - Anti-Microbial**  
Upholstered chairs have vinyl and an integrated filter applied to the underside of the seat to prevent dust and other contaminants from entering the environment

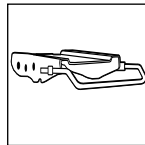





**Multi-Depth Mechansim**  
Standard on Granada models. Allows seat to move forward and backward over a 2" range with 5 locking positions to provide a more shallow or deeper seat.

STANDARD FEATURES



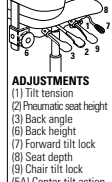

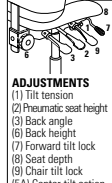

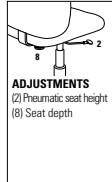

- \*Anti-Microbial models have a chrome back upright and polished aluminum base.
- Granada models feature a molded seat and contoured back with enhanced lumbar support.
- Granada models are standard with adjustable height T-arms with curved urethane armcaps (3N) in Black Only.
- Chrome chip/corrosion/humidity resistant pneumatic lift cylinders and frames.
- Chairs have a 5" chrome pneumatic cylinder, stools have a 10" chrome pneumatic cylinder.
- All chairs and stools have chrome back uprights and frames.
- Clear protective back bumper (full surround) is standard on all models.
- Standard with a five-legged, polished aluminum base.
- C10R casters are standard.
- All Bench Stools have chrome frames.
- Work Stools are shipped fully set-up.

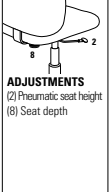

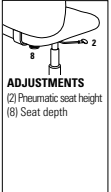

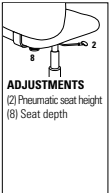
OPTIONAL FEATURES

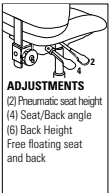
- See back of this section for additional arm or caster options.
- Optional casters may be priced higher than the standard casters for your chair and the difference will be charged. Lower priced optional casters will not be credited.
- All Anti-Microbial models are only available in grade 4 Generation Collection vinyls.

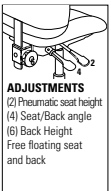
DESCRIPTION	FEATURES	MODEL#	STANDARD TEXTILE GRADES											
			1	2	3	4	5	6	7	8	9	10	11	12
 <b>LB Multi-Tilter</b> COM Yardage: 1.50 Freight Class: 150 Product Weight (lbs.): 54 Cubic Feet Per Carton: 13	 <b>ADJUSTMENTS</b> (1) Tilt tension (2) Pneumatic seat height (3) Back angle (6) Back height (7) Forward tilt lock (8) Seat depth (9) Chair tilt lock (5A) Center-tilt action	<b>3212-62</b>	-	1571	-	-	-	-	-	-	-	-	-	-
			<b>OVERALL DIMENSIONS</b>			<b>SEAT DIMENSIONS</b>			<b>BACK DIMENSIONS</b>					
			<b>W</b>	<b>D</b>	<b>H</b>	<b>W</b>	<b>D</b>	<b>H</b>	<b>W</b>	<b>H</b>				
			25.5	24.	40	20.5	17-19.5	18-23	19	17.5-21.5				
			<b>RTA 2</b>											
 <b>HB Multi-Tilter</b> COM Yardage: 1.75 Freight Class: 250 Product Weight (lbs.): 57 Cubic Feet Per Carton: 14.75	 <b>ADJUSTMENTS</b> (1) Tilt tension (2) Pneumatic seat height (3) Back angle (6) Back height (7) Forward tilt lock (8) Seat depth (9) Chair tilt lock (5A) Center-tilt action	<b>3217-62</b>	-	1616	-	-	-	-	-	-	-	-	-	-
			<b>OVERALL DIMENSIONS</b>			<b>SEAT DIMENSIONS</b>			<b>BACK DIMENSIONS</b>					
			<b>W</b>	<b>D</b>	<b>H</b>	<b>W</b>	<b>D</b>	<b>H</b>	<b>W</b>	<b>H</b>				
			25.5	24.5	43	20.5	17-19.5	18-23	19	21.5-25.5				
			<b>RTA 2</b>											
 <b>LB Task - Armless</b> COM Yardage: 1.50 Freight Class: 250 Product Weight (lbs.): 42 Cubic Feet Per Carton: 13	 <b>ADJUSTMENTS</b> (2) Pneumatic seat height (8) Seat depth	<b>3254-62</b>	-	1166	-	-	-	-	-	-	-	-	-	-
			<b>OVERALL DIMENSIONS</b>			<b>SEAT DIMENSIONS</b>			<b>BACK DIMENSIONS</b>					
			<b>W</b>	<b>D</b>	<b>H</b>	<b>W</b>	<b>D</b>	<b>H</b>	<b>W</b>	<b>H</b>				
			20.5	24	38	20.5	17.5-19	17-22	19	19				
			<b>RTA 2</b>											

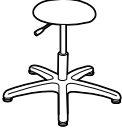
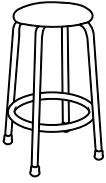

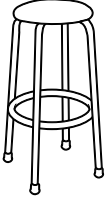
DESCRIPTION	FEATURES	MODEL#	STANDARD TEXTILE GRADES											
			1	2	3	4	5	6	7	8	9	10	11	12
 <p><b>LB Task</b> - w/3N Arms COM Yardage: 1.50 Freight Class: 250 Product Weight (lbs.): 42 Cubic Feet Per Carton: 13</p>	 <p><b>ADJUSTMENTS</b> (2) Pneumatic seat height (8) Seat depth</p>	<b>3255-62</b>	-	1300	-	-	-	-	-	-	-	-	-	
			<b>OVERALL DIMENSIONS</b>			<b>SEAT DIMENSIONS</b>			<b>BACK DIMENSIONS</b>					
			<b>W</b>	<b>D</b>	<b>H</b>	<b>W</b>	<b>D</b>	<b>H</b>	<b>W</b>	<b>H</b>				
			25.5	24	38	20.5	17.5-19	17-22	19	19				
			<b>RTA 2</b>											
 <p><b>Stool Task</b> - Armless COM Yardage: 1.50 Freight Class: 250 Product Weight (lbs.): 41 Cubic Feet Per Carton: 13</p>	 <p><b>ADJUSTMENTS</b> (2) Pneumatic seat height (8) Seat depth</p>	<b>3256-62</b>	-	1306	-	-	-	-	-	-	-	-	-	
			<b>OVERALL DIMENSIONS</b>			<b>SEAT DIMENSIONS</b>			<b>BACK DIMENSIONS</b>					
			<b>W</b>	<b>D</b>	<b>H</b>	<b>W</b>	<b>D</b>	<b>H</b>	<b>W</b>	<b>H</b>				
			20.5	24	48	20.5	17.5-19	24-34	19	19				
			<b>RTA 2</b>											
 <p><b>Stool Task</b> - w/3N Arms COM Yardage: 1.50 Freight Class: 250 Product Weight (lbs.): 45 Cubic Feet Per Carton: 15.50</p>	 <p><b>ADJUSTMENTS</b> (2) Pneumatic seat height (8) Seat depth</p>	<b>3257-62</b>	-	1437	-	-	-	-	-	-	-	-	-	
			<b>OVERALL DIMENSIONS</b>			<b>SEAT DIMENSIONS</b>			<b>BACK DIMENSIONS</b>					
			<b>W</b>	<b>D</b>	<b>H</b>	<b>W</b>	<b>D</b>	<b>H</b>	<b>W</b>	<b>H</b>				
			25.5	24	48	20.5	17.5-19	24-34	19	19				
			<b>RTA 2</b>											
 <p><b>Stool Operator</b> - Armless COM Yardage: 1.50 Freight Class: 250 Product Weight (lbs.): 48 Cubic Feet Per Carton: 13</p>	 <p><b>ADJUSTMENTS</b> (2) Pneumatic seat height (4) Seat/Back angle (6) Back Height Free floating seat and back</p>	<b>3278-62</b>	-	1518	-	-	-	-	-	-	-	-	-	
			<b>OVERALL DIMENSIONS</b>			<b>SEAT DIMENSIONS</b>			<b>BACK DIMENSIONS</b>					
			<b>W</b>	<b>D</b>	<b>H</b>	<b>W</b>	<b>D</b>	<b>H</b>	<b>W</b>	<b>H</b>				
			20.5	23.5	48	20.5	17.5	24-34	19	17.5-21.5				
			<b>RTA 2</b>											
 <p><b>Stool Operator</b> - w/3N Arms COM Yardage: 1.50 Freight Class: 250 Product Weight (lbs.): 54 Cubic Feet Per Carton: 15.50</p>	 <p><b>ADJUSTMENTS</b> (2) Pneumatic seat height (4) Seat/Back angle (6) Back Height Free floating seat and back</p>	<b>3288-62</b>	-	1651	-	-	-	-	-	-	-	-	-	
			<b>OVERALL DIMENSIONS</b>			<b>SEAT DIMENSIONS</b>			<b>BACK DIMENSIONS</b>					
			<b>W</b>	<b>D</b>	<b>H</b>	<b>W</b>	<b>D</b>	<b>H</b>	<b>W</b>	<b>H</b>				
			25.5	23.5	48	20.5	17.5	24-34	19	17.5-21.5				
			<b>RTA 2</b>											

DESCRIPTION	FEATURES	MODEL#	STANDARD TEXTILE GRADES													
			1	2	3	4	5	6	7	8	9	10	11	12		
 <p><b>Minotaur - Work Stool</b> COM Yardage: 0.75 Freight Class: 300 Product Weight (lbs.): 14 Cubic Feet Per Carton: 9.75</p>	5" Pneumatic  Ergonomic Features: C	9602-62	-	646	-	-	-	-	-	-	-	-	-	-		
			<b>OVERALL DIMENSIONS</b>			<b>SEAT DIMENSIONS</b>			<b>BACK DIMENSIONS</b>							
			<b>W</b>	<b>D</b>	<b>H</b>	<b>W</b>	<b>D</b>	<b>H</b>	<b>W</b>	<b>H</b>						
			14	14	17.5	14	-	15-20	-	-						
			<b>RTA 00</b>													
 <p><b>Minotaur - Work Stool</b> COM Yardage: 0.75 Freight Class: 300 Product Weight (lbs.): 16 Cubic Feet Per Carton: 13</p>	10" Pneumatic  Ergonomic Features: C	9604-62	-	697	-	-	-	-	-	-	-	-	-	-		
			<b>OVERALL DIMENSIONS</b>			<b>SEAT DIMENSIONS</b>			<b>BACK DIMENSIONS</b>							
			<b>W</b>	<b>D</b>	<b>H</b>	<b>W</b>	<b>D</b>	<b>H</b>	<b>W</b>	<b>H</b>						
			14	14	26.5	14	-	21.5-31.5	-	-						
			<b>RTA 00</b>													
 <p><b>Minotaur - Heavy Duty Work Stool</b> COM Yardage: 0.75 Freight Class: 250 Product Weight (lbs.): 17 Cubic Feet Per Carton: 5.50</p>		9624-62	-	685	-	-	-	-	-	-	-	-	-	-		
			<b>OVERALL DIMENSIONS</b>			<b>SEAT DIMENSIONS</b>			<b>BACK DIMENSIONS</b>							
			<b>W</b>	<b>D</b>	<b>H</b>	<b>W</b>	<b>D</b>	<b>H</b>	<b>W</b>	<b>H</b>						
			16	16	27.5	14	-	27.5	-	-						
			<b>RTA 00</b>													
 <p><b>Minotaur - Heavy Duty Work Stool</b> COM Yardage: 0.75 Freight Class: 250 Product Weight (lbs.): 19 Cubic Feet Per Carton: 5.50</p>		9632-62	-	708	-	-	-	-	-	-	-	-	-	-		
			<b>OVERALL DIMENSIONS</b>			<b>SEAT DIMENSIONS</b>			<b>BACK DIMENSIONS</b>							
			<b>W</b>	<b>D</b>	<b>H</b>	<b>W</b>	<b>D</b>	<b>H</b>	<b>W</b>	<b>H</b>						
			16	16	16	14	-	32.5	-	-						
			<b>RTA 00</b>													

WIPE DOWN - SEATING



**64 - Wipe Down**  
Furniture designed for dry food manufacturers, hospitals and forensic labs requiring regular and immediate clean up of dust, dirt or powder.



STANDARD FEATURES





- \*Wipe Down models have a black pneumatic cylinder.
- Minotaur Wipe Down models have comfortable Black, self-skinned polyurethane seats and backs.
- Chip/corrosion/humidity resistant pneumatic lift cylinders and frames.
- Stools have a 5" or 10" black pneumatic cylinder.
- All chairs have a chrome back upright.
- Standard with a five-legged, heavy duty molded base in Black.
- No arms are available for any work stools.
- All Bench Stools have chrome frames.
- Work Stools are shipped fully set-up.



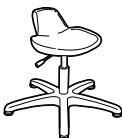

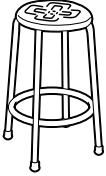
OPTIONAL FEATURES

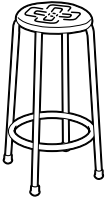
- Work stools are available with optional **C5** casters at no charge. Please Specify.
- See back of this section for additional arm or caster options.
- Optional casters may be priced higher than the standard casters for your chair and the difference will be charged. Lower priced optional casters will not be credited

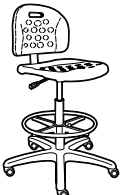
\* Images shown are for illustration purposes only.

DESCRIPTION	FEATURES	MODEL#	STANDARD TEXTILE GRADES													
			1	2	3	4	5	6	7	8	9	10	11	12		
 <b>Minotaur - Work Stool</b> COM Yardage: N/A Freight Class: 250 Product Weight (lbs.): 14 Cubic Feet Per Carton: 6.50	5" Pneumatic  Ergonomic Features: C	9602-64	503	-	-	-	-	-	-	-	-	-	-	-		
		<b>OVERALL DIMENSIONS</b>			<b>SEAT DIMENSIONS</b>			<b>BACK DIMENSIONS</b>								
		W	D	H	W	D	H	W	H							
			14	14	17.5	14	-	15-20	-	-						
			<b>RTA 00</b>													
 <b>Minotaur - Work Stool</b> COM Yardage: N/A Freight Class: 250 Product Weight (lbs.): 16 Cubic Feet Per Carton: 6.50	10" Pneumatic  Ergonomic Features: C	9604-64	556	-	-	-	-	-	-	-	-	-	-	-		
		<b>OVERALL DIMENSIONS</b>			<b>SEAT DIMENSIONS</b>			<b>BACK DIMENSIONS</b>								
		W	D	H	W	D	H	W	H							
			14	14	26.5	14	-	21.5-31.5	-	-						
			<b>RTA 00</b>													
 <b>Minotaur - Work Stool</b> COM Yardage: N/A Freight Class: 250 Product Weight (lbs.): 16 Cubic Feet Per Carton: 6.50	5" Pneumatic  Ergonomic Features: C	9611-64	605	-	-	-	-	-	-	-	-	-	-	-		
		<b>OVERALL DIMENSIONS</b>			<b>SEAT DIMENSIONS</b>			<b>BACK DIMENSIONS</b>								
		W	D	H	W	D	H	W	H							
			14	14	24.5	14	-	15-20	-	-						
			<b>RTA 00</b>													

DESCRIPTION	FEATURES	MODEL#	STANDARD TEXTILE GRADES													
			1	2	3	4	5	6	7	8	9	10	11	12		
 <p><b>Minotaur - Work Stool</b> COM Yardage: N/A Freight Class: 250 Product Weight (lbs.): 18 Cubic Feet Per Carton: 8.25</p>	<p>10" Pneumatic</p> <p>Ergonomic Features: C</p>	9612-64	655	-	-	-	-	-	-	-	-	-	-	-		
			<b>OVERALL DIMENSIONS</b>			<b>SEAT DIMENSIONS</b>			<b>BACK DIMENSIONS</b>							
			<b>W</b>	<b>D</b>	<b>H</b>	<b>W</b>	<b>D</b>	<b>H</b>	<b>W</b>	<b>H</b>						
			14	14	31	14	-	21.5-31.5	-	-						
			<b>RTA 00</b>													
 <p><b>Minotaur - Heavy Duty Work Stool</b> COM Yardage: N/A Freight Class: 250 Product Weight (lbs.): 17 Cubic Feet Per Carton: 5.50</p>		9624-64	503	-	-	-	-	-	-	-	-	-	-			
			<b>OVERALL DIMENSIONS</b>			<b>SEAT DIMENSIONS</b>			<b>BACK DIMENSIONS</b>							
			<b>W</b>	<b>D</b>	<b>H</b>	<b>W</b>	<b>D</b>	<b>H</b>	<b>W</b>	<b>H</b>						
			16	16	27.5	14	-	27.5	-	-						
			<b>RTA 00</b>													
 <p><b>Minotaur - Heavy Duty Work Stool</b> COM Yardage: N/A Freight Class: 250 Product Weight (lbs.): 19 Cubic Feet Per Carton: 5.50</p>		9632-64	525	-	-	-	-	-	-	-	-	-	-			
			<b>OVERALL DIMENSIONS</b>			<b>SEAT DIMENSIONS</b>			<b>BACK DIMENSIONS</b>							
			<b>W</b>	<b>D</b>	<b>H</b>	<b>W</b>	<b>D</b>	<b>H</b>	<b>W</b>	<b>H</b>						
			16	16	32.5	14	-	32.5	-	-						
			<b>RTA 00</b>													
 <p><b>Minotaur - Work Stool Task</b> COM Yardage: N/A Freight Class: 250 Product Weight (lbs.): 26 Cubic Feet Per Carton: 13</p>	<p>5" Pneumatic</p> <p>Ergonomic Features: C, E</p>	9662-64	706	-	-	-	-	-	-	-	-	-	-			
			<b>OVERALL DIMENSIONS</b>			<b>SEAT DIMENSIONS</b>			<b>BACK DIMENSIONS</b>							
			<b>W</b>	<b>D</b>	<b>H</b>	<b>W</b>	<b>D</b>	<b>H</b>	<b>W</b>	<b>H</b>						
			18	21	32	18	16.5-19	14-19	16.5	16						
			<b>RTA 00</b>													
 <p><b>Minotaur - Work Stool Task</b> COM Yardage: N/A Freight Class: 250 Product Weight (lbs.): 33 Cubic Feet Per Carton: 13</p>	<p>10" Pneumatic</p> <p>Ergonomic Features: C, E</p>	9663-64	857	-	-	-	-	-	-	-	-	-	-			
			<b>OVERALL DIMENSIONS</b>			<b>SEAT DIMENSIONS</b>			<b>BACK DIMENSIONS</b>							
			<b>W</b>	<b>D</b>	<b>H</b>	<b>W</b>	<b>D</b>	<b>H</b>	<b>W</b>	<b>H</b>						
			18	20.5	42	18	16.5-19	14-19	16.5	16.5						
			<b>RTA 00</b>													

DESCRIPTION	FEATURES	MODEL#	STANDARD TEXTILE GRADES													
			1	2	3	4	5	6	7	8	9	10	11	12		
 <p><b>Minotaur - Stool Posture Task</b> COM Yardage: N/A Freight Class: 250 Product Weight (lbs.): 30 Cubic Feet Per Carton: 13</p>	5" Pneumatic  Ergonomic Features: C, D	<b>9664-64</b>	806	-	-	-	-	-	-	-	-	-	-	-		
		<b>OVERALL DIMENSIONS</b>			<b>SEAT DIMENSIONS</b>			<b>BACK DIMENSIONS</b>								
		<b>W</b>	<b>D</b>	<b>H</b>	<b>W</b>	<b>D</b>	<b>H</b>	<b>W</b>	<b>H</b>							
			18	20	31	18	16	14-19	16.5	12.5-19						
			<b>RTA 2</b>													
 <p><b>Minotaur - Stool Posture Task</b> COM Yardage: N/A Freight Class: 250 Product Weight (lbs.): 33 Cubic Feet Per Carton: 13</p>	10" Pneumatic  Ergonomic Features: C, D	<b>9665-64</b>	957	-	-	-	-	-	-	-	-	-	-			
		<b>OVERALL DIMENSIONS</b>			<b>SEAT DIMENSIONS</b>			<b>BACK DIMENSIONS</b>								
		<b>W</b>	<b>D</b>	<b>H</b>	<b>W</b>	<b>D</b>	<b>H</b>	<b>W</b>	<b>H</b>							
			18	20	39	39	16	20.5-30.5	16.5	12.5-19						
			<b>RTA 2</b>													
 <p><b>Minotaur - Stool Operator</b> COM Yardage: N/A Freight Class: 250 Product Weight (lbs.): 34 Cubic Feet Per Carton: 13</p>	5" Pneumatic  Ergonomic Features: C, D, F, G	<b>9666-64</b>	949	-	-	-	-	-	-	-	-	-	-			
		<b>OVERALL DIMENSIONS</b>			<b>SEAT DIMENSIONS</b>			<b>BACK DIMENSIONS</b>								
		<b>W</b>	<b>D</b>	<b>H</b>	<b>W</b>	<b>D</b>	<b>H</b>	<b>W</b>	<b>H</b>							
			18	20.5	32	18	17	15-20	16.5	12.5-19						
			<b>RTA 2</b>													
 <p><b>Minotaur - Stool Operator</b> COM Yardage: N/A Freight Class: 250 Product Weight (lbs.): 35 Cubic Feet Per Carton: 13</p>	10" Pneumatic  Ergonomic Features: C, D, F, G	<b>9667-64</b>	1100	-	-	-	-	-	-	-	-	-	-			
		<b>OVERALL DIMENSIONS</b>			<b>SEAT DIMENSIONS</b>			<b>BACK DIMENSIONS</b>								
		<b>W</b>	<b>D</b>	<b>H</b>	<b>W</b>	<b>D</b>	<b>H</b>	<b>W</b>	<b>H</b>							
			18	20.5	42	18	17	21-31	16.5	12.5-19						
			<b>RTA 2</b>													

**ACADEMIC REPLACEMENT ARMS**

(For Task Seating models ONLY)



Arms other than those provided as standard on your chair.

Refer to chart below for availability by series and associated upcharge (if any).

	STD	AL	F	O	OJ	TD	ZH	3N	4J	4M	4T	GL	9B	9S
<b>GOAL</b>	3N	NR	NR	34	85	34	NR	STD	112	61	61	NR	159	NR
<b>GRANADA</b>	3N	61	159	34	85	34	0	STD	112	61	61	59	159	85
<b>OBUSFORME</b>	TD	0	98	0	51	STD	0	0	51	0	0	0	98	24

**INDUSTRIAL REPLACEMENT ARMS**

Optional arms for INDUSTRIAL and ESD seating ONLY.

 <p><b>3N</b></p>	Industrial Seating Series	Options	*Replacement Arm Price	**Optional Arm Price
	Adjustable height T-arm, Curved	urethane	STD	167
 <p><b>2Z</b></p>	Industrial Seating Series	Options	*Replacement Arm Price	**Optional Arm Price
	Fixed height T-arm, Kidney Shaped	upholstered	STD (ESD Models)	83

Notes:

\* Use this column to select another arm other than the one provided on your chair.

\*\* Use this column to select arms for a chair that doesn't come with arms.



<b>C5</b>	Large Ball Caster	Chrome Hood/ Black Ball	Hard Floor	1 each	<b>14</b>
-----------	-------------------	----------------------------	------------	--------	-----------

Available as a substitute for C56 glides on Wipe Down Work stools at no charge.



<b>C7R</b>	Slipper Glide		All surface except ESD	1 each	<b>16</b>
------------	---------------	--	---------------------------	--------	-----------

Standard on Industrial, Anti-Microbial and Wipe Down Minotaur Work stools.

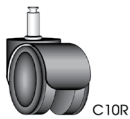

<b>C10R</b>	Integrated Dual Wheel Rubber Coated Caster	Black	Vinyl, Marble, Hardwood Floor	1 each	<b>30</b>
-------------	---	-------	----------------------------------	--------	-----------

Standard on Industrial, Clean Room #1000 and Wipe Down Minotaur stools and Clean Room #1000 and Anti-Microbial Granada models.



<b>C38R</b>	Non-Braking, Dual Wheel, Caster w/ESD	Die Cast Zinc Chrome Plated Hood Wheels - First Grade Polyamide w/ Soft polyurethane tread.	Hard Floor Surfaces	1 each	<b>40</b>
-------------	--	---	---------------------	--------	-----------

Standard on ESD chairs and stools.



<b>C39R</b>	Dual Wheel, Hard Floor Safety Caster w/Interval Brake	Galvanized Steel Axle w/Chrome Plated Hood Zinc die cast frame)	Hard Floor Surfaces	1 each	<b>38</b>
-------------	---	--	---------------------	--------	-----------

Standard on Industrial chairs and stools. Weight activated release brake helps to prevent chair from moving when not in use.



<b>C40</b>	Dual Wheel Safety Caster w/ESD, Interval Brake	Galvanized Steel Axle w/Chrome Plated Hood (Zinc die cast frame)	Carpeted Surfaces	1 each	<b>38</b>
------------	--	---	-------------------	--------	-----------

Available as a substitute on ESD chairs and stools only. Weight activated release brake helps to prevent chair from moving when not in use.



<b>C40R</b>	Dual Wheel, Hard Floor Safety Caster w/ESD, Interval Brake	Galvanized Steel Axle w/Chrome Plated Hood (Zinc die cast frame)	Tiled Surfaces	1 each	<b>42</b>
-------------	--	---	----------------	--------	-----------

Available as a substitute on ESD chairs and stools only. Weight activated release brake helps to prevent chair from moving when not in use.



<b>C42</b>	High Profile Steel Glide w/ESD w/Impact Resistant Polymer Glide	Steel Stem and Shell (Zinc plated steel stem)	All Surfaces	1 each	<b>16</b>
------------	--	--	--------------	--------	-----------

Standard on Minotaur Heavy Duty Bench stools and Work stools with ESD



<b>C65R</b>	2" Dual Wheel Rubber Coated Caster	Black	All surfaces except ESD	1 each	<b>23</b>
-------------	---------------------------------------	-------	----------------------------	--------	-----------

Standard on Clean Room #1000 Minotaur work stools.

**INDUSTRIAL CASTERS NOTES:**

- Prices listed for Industrial Casters are upcharges when substituted on Industrial chair orders.
- Industrial Casters are Not suitable for use on standard Global seating products.
- All casters are Not appropriate for all flooring surfaces. Please consult with your Sales Representative or Global Customer Service Representative for special situations that can be verified with the caster manufacturer. Alternate casters, if needed, may require an upcharge.

**PLEASE SPECIFY ALL SUBSTITUTIONS AND OPTIONS.**



# textiles and finishes

## Care and Cleaning

### TEXTILES

**Fabrics:** To extend the life of your seating upholstered in fabric, regularly dust the chair to prevent airborne particles from penetrating the fabric surface.

For light soiling, use a damp cloth and blot the spot with very slight pressure, taking care never to soak the fabric. Dry with a clean cloth by blotting - never rub fabric. More intense stains can be treated the same way, but with a mild detergent. Always test fabric first in an unseen area before using any cleaning method.

**Leather:** For regular cleaning, simply use a soft damp cloth, taking care not to soak the leather. For more thorough treatment, soak a soft cloth in mild soap solution and wipe surface in a light circular motion. Repeat with clean water. Allow to dry and polish with a soft dry cloth. Do not use detergents, aerosol sprays or other polishes.

### Various Care and Cleaning Methods

- **Water-Based Cleaner:** Spot clean, using the foam only from a water-based cleaning agent, such as a mild detergent or non-solvent upholstery shampoo product. Apply foam with a soft brush in a circular motion. Vacuum when dry. Pretest small area before proceeding.
- **Solvent Cleaner:** Spot clean, using a mild water-free solvent or dry cleaning product. Clean only in a well-ventilated room and avoid any product containing carbon tetrachloride or other toxic materials. Pre-test a small area before proceeding.
- **Water/Solvent Cleaner:** Spot clean with amid solvent, an upholstery shampoo, or the foam from a mild detergent. When using a solvent or dry cleaning product, follow instructions carefully and clean only in a well-ventilated room. Avoid any product that contains carbon tetrachloride or other toxic materials. With either method, pretest a small area before proceeding.
- **Vacuum Only:** Clean this fabric only by vacuuming or light brushing to prevent accumulation of dust and grime. Water-based foam cleaning agents of any kind may cause excessive shrinking, staining, or distortion of the surface pile and therefore, should not be used.
- **Crypton Cleaning:** Generally stains are removed with plain water and powdered enzyme detergent. Upholstery foam shampoo, water-based cleaning products and germicidal detergents can be used. Be sure to remove all residue from cleaning products with clean water. Do not use solvent-based cleaners or dry cleaning products.

---

### HARD SURFACES

**Wood Veneer Finishes:** Waxing or polishing catalyzed finishes is not recommended because this will give a greasy, cloudy or uneven appearance to the product and could void your warranty. Global's conversion varnish is best cleaned by wiping the surface with a damp cloth, followed by a soft dry cloth in the direction of the grain. If the surfaces are heavily soiled, a gentle product like "Windex" can be used, following the same instructions as above.

**Laminate & Painted Metal Finishes:** Using a soft cloth, simply wipe the surface with a mild soap solution or glass cleaner. Always use a dry cloth and circular motion to prevent streaks.





# TEXTILES & FINISHES

## Textile Price Grades - Global Textiles

- Grade 1 Carrera, Fusion, Hudson, Illusion, Jenny, Mock Leather, Quilt, Terrace, Urban, Waterfall, Wavelength
- Grade 2 Allante FRee, Couture, Crescent, Elevate, Etch, GC Linen, Imprint, Match, Release, Renewal, Replay, Silhouette
- Grade 3 Pure, Vital, non standard GLOBAL textiles
- Grade 4 Non standard GLOBAL textiles
- Grade 5 Leather/Mock Leather combination
- Grade 6 Non standard GLOBAL textiles
- Grade 7 Non standard GLOBAL textiles
- Grade 8 Genuine Leather, Non standard GLOBAL textiles
- Grade 9 Non standard GLOBAL textiles
- Grade 11 Non standard GLOBAL textiles
- Grade 10 Non standard GLOBAL textiles
- Grade 12 Non standard GLOBAL textiles

Please refer to individual seating series for availability of a particular textile.

The charts above do not include Textiles offered by Alliance Partners: Arc-Com Fabrics, CF Stinson, Designtex, Knoll Textiles, Green Hides, LDI Interiors, Luum Textiles, Maharam, Mayer Fabrics, Momentum, and Ultrafabrics.

## Blend Seating Textiles

The grid below outlines the grade structure for using multiple textiles on select seating series. Blended textiles occur when one textile is chosen for one part of the chair and a different textile is selected for another part of the chair, resulting in a revised blended grade. For opportunities regarding more than two different textiles, please contact Global CustomerCare for approval process and grading.

### FIRST TEXTILE SELECTED

		FIRST TEXTILE SELECTED																	
		1	2	3	4	5	6	7	8	9	10	11	12	13	14	15	16	17	18
SECOND TEXTILE SELECTED	1	1																	
	2	2	2																
	3	3	3	3															
	4	3	4	4	4														
	5	4	4	5	5	5													
	6	5	5	5	6	6	6												
	7	5	6	6	6	7	7	7											
	8	6	6	7	7	7	8	8	8										
	9	7	7	7	8	8	8	9	9	9									
	10	8	8	8	8	9	9	9	10	10	10								
	11	9	9	9	9	9	10	10	10	11	11	11							
	12	10	10	10	10	10	10	11	11	11	12	12	12						
	13	11	11	11	11	11	11	12	12	12	12	13	13	13					
	14	11	12	12	12	12	12	12	13	13	13	13	14	14	14				
	15	12	12	13	13	13	13	13	13	14	14	14	14	15	15	15			
	16	13	13	13	14	14	14	14	14	14	15	15	15	15	16	16	16		
	17	14	14	14	14	15	15	15	15	15	15	16	16	16	16	17	17	17	
	18	15	15	15	15	15	16	16	16	16	16	16	17	17	17	17	18	18	18

Textile and Color Listings

Grade 1

**Carrera** 100% Polyester

CE84 Zest	CE85 Savannah	CE86 Slate	CE87 Rainforest	CE88 Aspen	CE89 Dune	CE90 Flannel
CE91 Azure	CE92 Chili	CE93 Jute	CE95 Ink	CE96 Sangria	CE97 Java	CE98 Charcoal

**Fusion** 90% Virgin Polyester / 10% Post-Consumer Recycled Polyester

FU71 Tangerine	FU72 Fresh	FU73 Moss	FU74 Tomato	FU75 Aqua	FU76 Sandstone	FU77 Granite
FU78 Poppy	FU79 Cadet	FU80 Oasis	FU81 Graphite	FU82 Viola	FU83 Cobalt	FU84 Flax
FU85 Carbon						

**Hudson** 100% Post-Consumer Recycled Polyester

HD02 Cordovan	HD03 Ruby	HD04 Orange	HD05 Wheat	HD06 Meadow	HD07 Coffee	HD08 Grey
HD09 Mocha	HD10 Thyme	HD11 Carbon	HD12 Midnight	HD13 Ocean	HD14 Cerulean	

**Illusion** 100% Virgin Polyester

IL01 Cappuccino	IL02 Paprika	IL03 Tropic	IL04 Wicker	IL05 Hemp	IL06 Cayenne	IL07 Maui
IL08 Dusk	IL09 Smoke	IL10 Currant	IL11 Fiji	IL12 Ozone	IL13 Ebony	

**Jenny** 100% Polyester

JN01 Midnite	JN02 Ebony	JN03 Slate	JN07 Vermilion	JN08 Admiral	JN11 Charcoal	JN25 Silver Lining
JN26 Oatmeal	JN27 Sunflower	JN28 Cascade	JN29 Harvest	JN30 Melon	JN31 Berry	JN32 Green Grass
JN33 Roast						

**Mock Leather** 100% Polyvinyl Chloride

550 Black	559 Chamois	570 Surf	571 Latte	572 Melon	573 Delta	576 Jade
574 Bronze	575 Rouge	577 Graphite	578 Chaps	579 Cabernet	591 Alpine	

**Quilt** 100% Polyester

QL10 Black	QL11 Charcoal Grey	QL14 Navy	QL16 Wine	QL19 Silver	QL20 Feather	QL21 Dune
QL22 Meadow	QL23 Cadet	QL24 Geranium	QL25 Daisy	QL26 Quest	QL27 Punch	QL28 Tangerine
QL29 Cocoa						

**Terrace** 70% Virgin Polyester / 30% Post-Consumer Recycled Polyester

TC61 Tigerlily	TC62 Shadow	TC63 Cobble	TC64 Cherry Blossom	TC65 Bluebell	TC66 Apple	TC67 Haze
TC68 Cerise	TC69 Twilight	TC70 Wintergreen	TC71 Ironwork	TC72 Pine Cone	TC73 Flirt	TC74 Echo
TC75 Glacier						

**Urban** 62% Recycled Polyester / 32% Polyester

UR10 Red Rose	UR11 Ocean Blue	UR12 Blue Bayou	UR13 Green Grass	UR14 Sandcastle	UR15 Beach Day	UR16 Boardwalk
UR17 Earth	UR18 Brown Ridge	UR19 White Sand	UR20 Granite Rock	UR21 Gravel Road	UR22 Black Coal	

**Waterfall** 60% Virgin Polyester / 40% Post-Consumer Recycled Polyester

WA40 Trance	WA41 Tryst	WA42 Splash	WA43 Victoria	WA44 Imagine	WA45 Sky	WA46 Rainforest
WA47 Rumble	WA48 Prism	WA49 Tranquility	WA50 Grand	WA51 Rushing	WA52 Magestic	WA53 Pacific
WA54 Dance						

**Wavelength** 100% Virgin Polyester

WV01 Lime	WV02 Mint	WV03 Stone	WV04 Flame	WV05 Mykonos	WV06 Savannah	WV07 Mesa
WV08 Plasma	WV09 Cancun	WV10 Quartz	WV11 Moonrock	WV12 Rubine	WV13 Corfu	WV14 Bluejay
WV14 Panther						

Grade 2

**Crescent** 100% Nylon with Teflon Designed to color coordinate with Renewal fabrics.

700 Cocoa	701 Pear	702 Silver	703 Oatmeal	704 Lemon	705 Flame	706 Stem
709 Ruby	789 Raven	790 Cobalt Blue	792 Cinder Grey	799 Pine	800 Arctic	

**Elevate** 80% Post-Consumer Recycled Polyester/ 20% Rayon

EL51 Halo	EL52 Dove	EL53 Safari	EL54 Sunflow	EL55 Margarita	EL56 Fiji	EL57 Mist
EL58 Blaze	EL59 Wasabi	EL60 Mystic	EL61 Mica	EL62 Cherry	EL63 Scuba	EL64 Lapis
EL65 Onyx						

**Etch** 80% Post-Consumer Recycled Polyester/ 20% Rayon

ET81 Drift	ET82 Citron	ET83 Calypso	ET84 Mandarin	ET85 Crisp	ET86 Iris	ET87 Nickel
ET88 Paprika	ET89 Nutmeg	ET90 Marine	ET91 Magnet	ET92 Infrared	ET93 Espresso	ET94 Indigo
ET95 Anthracite						

# TEXTILES & FINISHES

## Grade 2 (continued)

### Imprint 100% Post-Consumer Polyester

IM70 Almond	IM71 Cork	IM72 Sand	IM73 Currie	IM74 Candy Apple	IM75 Ocean	IM76 Navy
IM77 Green Tea	IM78 Celery	IM79 Oregano	IM80 Walnut	IM81 Paprika	IM82 Graphite	IM83 Slate
IM84 Licorice						

### Match 100% Recycled Polyester

MT20 Desert	MT21 Sand	MT22 Moss	MT23 Orange	MT24 Sunset	MT25 Blue	MT26 Wave
MT27 Green	MT28 Chocolate	MT29 Burgundy	MT30 Grey	MT31 Quarry	MT32 Black	MT33 Arctic

### Renewal 70% Nylon / 30% Recycled Polyester with Teflon Designed to color coordinate with Crescent fabrics.

RN30 Pewter	RN31 Cork	RN32 Cherry Fields	RN33 Volcanic Ash	RN34 Thunderstorm	RN36 Blue Grass	RN38 Leaf
RN39 Melon	RN40 Blueberry	RN41 Blue Bayou	RN44 Tomato	RN45 Amethyst	RN47 Ochre	

### Replay 100% Post-Consumer Recycled Polyester

RP20 Taupe	RP21 Caramel	RP22 Paprika	RP23 Wine	RP24 Ocean	RP25 Navy	RP26 Pistachio
RP27 Moss	RP28 Turquoise	RP29 Teal	RP30 Autumn	RP31 Dark Chocolate	RP32 Slate	RP33 Dove
RP34 Coal						

### Silhouette 100% Nylon with Teflon

SL20 Asphalt	SL21 Acorn	SL22 Indigo	SL23 Shiraz	SL24 Verdant	SL25 Bronze	SL26 Camel
SL27 Jade	SL28 Sienna	SL30 Charcoal	SL32 Claret	SL35 Hunter	SL36 Sapphire	

## Grade 2 (Vinyl) For availability of chair series in Vinyl, please contact a Global Sales Representative.

### Allante Free 100% Vinyl Face / 100% Polyester Backing

A01F Illusion	A02F Bright White	A03F White Crush	A04F Ivory	A05F Ice	A06F Bleached Sand	A07F Taupe Fawn
A08F Warm Smoke	A09F Autumn Rain	A10F Cookie	A11F Sierra Brick	A12F Gibraltar	A13F Chateau Grey	A14F Garden Green
A15F Oasis Green	A16F Ink Black	A17F Purple Impulse	A18F Italian Rose	A19F Mountain Sky	A20F Old Navy	A21F Galaxy
A22F Red Truffle	A23F Chocolate Sundae	A24F Province Blue	A25F Eclipse			

### GC Linen 100% Vinyl Face

LE50 Potters Clay	LE51 Pearl	LE52 Tan	LE53 Storm	LE54 Butter	LE55 Haystack	LE56 Ganache
LE57 Sunset	LE58 Burnt Orange	LE59 Cayenne	LE60 Navy	LE61 Bamboo	LE62 Gray	LE63 Charcoal
LE64 Moss						

### Release 100% Vinyl Face

RL11 White	RL12 Chalk	RL13 Stone	RL14 Taupe	RL15 Orange	RL16 Country	RL17 Tucson
RL18 Cottage	RL19 Yellow	RL21 Red Barn	RL22 Brave Red	RL23 Gypsy Red	RL24 Cajun	RL25 Vineyard
RL26 Olive	RL27 Bonsai	RL28 Summer's Dream	RL29 Calico	RL31 Green	RL32 Blue	RL33 Black
RL34 Cool Grey	RL35 Thunder Grey	RL36 Navy	RL37 Dark Chocolate	RL38 Espresso		

## Grade 2 (Recycled)

### Couture 100% Post-Consumer Polyester

CE70 Champagne	CE71 Mocha	CE72 Pecan	CE73 Raspberry	CE74 Sapphire	CE75 Neptune	CE76 Lake
CE77 Willow	CE78 Sassy	CE79 Fudge	CE80 Persimmon	CE81 Carbon	CE82 Sterling	CE83 Peat

## Grade 5

### Genuine Leather/Mock Leather combinations 100% Leather / 100% Polyvinyl Chloride

450/550 Black	459/559 Chamois	470/570 Surf	471/571 Latte	472/572 Melon	473/573 Delta	474/574 Bronze
475/575 Rouge	476/576 Jade	477/577 Graphite	478/578 Chaps	479/579 Cabernet	491/591 Alpine	

## Grade 8

### Genuine Leather 100% Leather

450 Black	459 Chamois	470 Surf	471 Latte	472 Melon	473 Delta	474 Bronze
475 Rouge	476 Jade	477 Graphite	478 Chaps	479 Cabernet	491 Alpine	

## Panel Fabrics

### Grade 1

#### Agate II 100% Polypropylene

AG21 Bamboo      AG22 Linen      AG24 Slate      AG25 Grey      AG27 Mauve

### Grade 2

#### Lola 100% Polyester Designed to color coordinate with Brinx and Mariposa panel fabrics.

LL11 Medium Taupe      LL12 Caramel Cream      LL13 Straw      LL14 Blue Mist      LL15 Zucchini      LL16 Natural      LL17 Cafe Au Lait  
 LL18 Mortar      LL19 Black

### Grade 3

#### Accent 100% Polyester Fabric Grades are different when used on eO+ and GPS II panels. Please refer to 2017 Desking list price book for details.

GC31 Sand Dune      GC32 Limestone      GC33 Silver Mint      GC34 Skyway      GC35 Warm Beige      GC36 Mid-Grey      GC37 Green Olive  
 GC38 Cloud Blue      GC39 Desert Cactus      GC40 Cinder Block      GC41 Sage Brush      GC42 Brickworks

#### Brinx 100% Polyester Designed to color coordinate with Lola and Mariposa panel fabrics.

BX01 Taupe      BX02 Caramel      BX03 Green Apple      BX04 Brick      BX05 Blue Steel      BX06 Bisque      BX07 Hot Chocolate  
 BX08 Golden

#### Mariposa 100% Polyester Designed to color coordinate with Lola and Brinx panel fabrics.

MA41 Mocha      MA42 Blue Ocean      MA43 Claypot      MA44 Champagne      MA45 Granny Smith      MA46 Butterscotch      MA47 Mixed Taupe  
 MA48 Wheat

## Finishes

#### Seating Finishes - Metal: Please consult each Seating Series for finish availability.

Black (BK)      Charcoal Grey (CHR)      Chrome (CH)      Fog (FG)      Polished Aluminum (ALU)      Tungsten (TUN)

#### Seating Finishes - Plastic (Duet, Popcorn, and Sonic)

Buzz Blue (BZB)      Cactus (CCT)      Carrot (CRO)      Cloud (IVC)      Dijon (DJN)      Eggplant (EGP)      Fog (FOG)  
 Frost (FRO)      Ink (INK)      Latte (LAB)      Night (BLK)      Sand (SND)      Scarlet (SAR)      Shadow (SHW)

#### Seating Finishes - Wood Seating finishes will not necessarily match Casegoods finishes. This is due to the fact that Seating and Casegoods finishes use different wood species and are manufactured at multiple locations.

Absolute (AAM)      Black (BKM)      Cherry (ACM)      Espresso Cafe (ECM)      English Oak (EOM)      Fruitwood (TFM)      Gray (HGM)  
 Honey (AHM)      Mahogany (TMM)      Maple (AVM)      Medium Walnut (MWM)      Night (ASM)      Shaker Cherry (SKM)      Walnut (TWM)  
 WC Cream (WTM)      White (WHM)      Winter Cherry (WCM)

#### Desks, Workstations, Tables and Accessories - Laminate

Absolute Acajou (ACJ)      Asian Night (ASN)      Avant Cherry (AWC)      Avant Honey (AWH)      Black (BLK)      Brushed Cobalt (BRC)      Dark Espresso (DES)  
 Hayden Grey (HGT)      Quartered Mahogany (QTM)      Storm Grey (SOG)      Tiger Fruitwood (TFW)      Tiger Walnut (TWL)      White Chocolate (WHC)      Willow Grey (WGY)  
 Winter Cherry (WCR)

#### Desks, Workstations, Tables and Accessories - Veneer Wood

Almond Cherry (AMW)      Caramel Bamboo (BAMC)      Cocoa Walnut (CAW)      Coral (CRW)      Dark Cherry (DCW)      Espresso Walnut (EWW)      Evening Oak (EVW)  
 Grey on Oak (GRW)      Hazelnut (HAW)      Honey Maple (SMW)      Java (JAW)      Latte Walnut (LTW)      Milestone (MTW)      Mocha (MCW)  
 Natural Maple (MPW)      Red Cherry (RCW)      Vintage Cherry (VNW)      Walnut (WLV)      Warm Cherry (WCW)      White Maple (WMW)

#### File Finishes - Standard

Black (BLK)      Business Grey (BGR)      Charcoal Grey (CGR)      Desert Putty (DPT)      Grey (GRY)      Light Grey (LGR)      Nevada (NEV)  
 Storm Grey (SGR)      Tahiti Sand (TSA)

#### File Finishes - Premium

Bone (F29)      Claret (F09)      Cloud (F23)      Designer White (DWT)      Ice (F33)      Ivory (F30)      Metro (F07)  
 Moss (F05)      Navy (F19)      Oyster (F35)      Stone (F32)      Tungsten 2 (TU2)      Willow (F28)

#### File Finishes - Textured

Black Coffee (U04)      Dark Chocolate (T19)      Cappuccino (T20)      Mocha (J52)      Vanilla (J23)

# C.O.M. AUTHORIZATION FORM

## CUSTOMER INFORMATION

To be completed by the dealer/design firm. Use one form per textile. Incomplete information may delay or prevent approval.

A+D/Dealer/Company Name:		Contact:	
Billing Address:		Phone:	
City:	State:	Zip:	Email:
End-User/Project Name:		End-User/Project Registered? YES <input type="checkbox"/> NO <input type="checkbox"/> If YES, The Global Quote#:	
Local Global Distribution Center:		Date:	

## TEXTILE APPLICATION INFORMATION

SEATING MODEL NUMBER	QUANTITY	SPECIAL INSTRUCTIONS

Textile Name (Series/Style #):		
Textile Color Name and Description:		
Country of Origin:		
Mill or Manufacturer's Name:		
Textile Content (% Cotton, % Poly, % Wool, etc.):		
Textile Width:	Pattern Repeat: VERTICAL <input type="checkbox"/> HORIZONTAL <input type="checkbox"/>	Rail Routed? YES <input type="checkbox"/> NO <input type="checkbox"/>

### TEXTILE DIRECTION



**STAPLE FABRIC TO THIS FORM IN THE DIRECTION IN WHICH THE FABRIC IS TO BE UPHOLSTERED WITH THE TOP OF THIS PAGE BEING THE SAME AS THE TOP OF THE CHAIR.**

#### NEW TEXTILE

Attached textile sample  
(Minimum 5"x5" Max 12"x12")  
In correct DIRECTION and SIDE.

#### PREVIOUSLY APPROVED TEXTILE

Please e-mail completed form to:  
ComRequest@globalfurnituregroup.com

#### MAIL FORM AND TEXTILE SAMPLE ONLY TO:

GLOBAL - COM Department  
17 West Stow Road  
Marlton, NJ 08053 | 856.596.3390

Please contact your local GLOBAL Distribution Center for status of all COM requests. When textile is approved and an authorization number issued, a set of shipping instructions will be faxed or e-mailed to you.

Approved textiles are to be shipped to the address that will be included with instructions. Do not ship textiles to the address on this form. Dealer is responsible for the shipping expenses. Brokerage fees will be paid for by Global. However, duties imposed by North American Governments related to textile materials, content and Country of Origin, additional fees may apply and will be billed separately.

Please Note: C.O.M Textiles may not be shipped without shipping documents. GLOBAL is not responsible for any material shipped without the authorization number.

**Please be advised that Global has phased out the use of textiles that contain certain Phthalates, including but not limited to: DEHP ( di (2-ethylhexyl) phthalate), DBP (di-n-butyl phthalate), BBP (butyl benzyl phthalate) and DINP (di-isononyl phthalate) (collectively the "Listed Chemicals"). The Listed Chemicals are used in certain types of vinyls. Global cannot accept orders for textiles that contain the Listed Chemicals, if such orders are to be shipped to the U.S.A. or are intended for customer in the U.S.A. If you are not sure if the C.O.M you have selected contains the Listed Chemicals, please contact the manufacturer or supplier of the fabric to verify.**

## GLOBAL AUTHORIZATION FORM (TO BE COMPLETED BY GLOBAL)

CAN#:	TEXTILE YARDAGE (REQUIRED FOR THE ORDER):	GU CODE:
-------	---	----------



**LEVEL 3 CERTIFIED**  
Many programs in various categories



**LEED PARTNERSHIP PROGRAM**  
Products can help you earn credits



**GREENGUARD CERTIFIED**  
Gold

**THE ENVIRONMENT** We believe now more than ever, that it is our responsibility to protect the environment and our precious natural resources for future generations. The growing importance of energy and environmental concerns continues to challenge us in this ever changing marketplace.

As an industry leader, Global continues to take proactive steps towards reducing the negative impacts on the environment. We are building "healthier" offices; investing in Research & Development and new technologies; reducing waste and the consumption of energy; and improving the quality of the air we breathe, all which can have a significant impact on our quality of life.



Epoxy Powder coating process is solvent free. No harmful VOC's or lead. No toxins are released into the atmosphere.

Global's recycled fabrics offer affordable, environmentally responsible alternatives to commercial textiles. We recycle 35,000 lbs of fabric offcuts weekly.



powder paint process:  
**98% paint recovery and reuse**

more recycled fabric  
**less to the landfill**

talk to us about our  
**leed partnership program**

we've diverted  
**90% of our wood waste from landfill in four years**



Global has the products and resources to help your projects achieve LEED certification.

New technology allows us to reduce glue usage by 50%. In addition, our polyurethane glue reduces emissions and requires less energy to apply.



For further information on Global's environmental initiatives, please visit <http://www.globaltotaloffice.com/enviro/>

# TERMS & CONDITIONS

This illustrated price list has been designed to facilitate fast reference and easy use. All products are categorized into "seating", "desks", "files", "panels", "tables" and "modular furniture", and are listed numerically within their categories. The line drawings match actual photographs (where possible) to aid in instant recognition of the total range within a series.

Sales of Global-The Total Office ("Global") products are made only on Global's standard terms and conditions of sale which are contained in this Price Book. These standard terms and conditions may be modified or supplemented only by a separately written document signed by Global's authorized personnel at its head office in Marlton, NJ. Any term or condition contained in any purchase order or other form used by dealer/purchaser to order goods (including standard, printed language) which is different from, in addition to, or in any way inconsistent with Global's standard terms and conditions shall be of no force or effect whatsoever.

All illustrations, specifications and prices in this book are based on the latest product information available at the time of publication. Global reserves the right to make changes, at any time and without prior notice, to prices, colors, materials, specifications and models offered.

## Description

Each product shown or described in this price list is standard Global product. Variations are noted at the beginning of each series. Any variations from what is standard may require additional delivery time and cost and may affect the warranty given. Sizes and weights shown are approximate and are subject to slight changes from time to time.

## Prices and Payment

The prices shown in this book, as well as those quoted by Global, are in United States dollars for orders shipped to destinations in the U.S. and Mexico.

If shipping date requested is more than 90 days from date of order, Global shall have the right to use published list prices effective at the time of shipment.

Orders are invoiced at the time of shipment. Terms of payment are net 30 days from date of invoice (1% 15 days) unless otherwise stated. The customer agrees that Global shall have the right to enforce a charge amounting to 1.5% per month (18% per year) on invoices outstanding more than 30 days.

If dealer/purchaser's most recent annual net volume is less than \$5,000.00, payment must be made in advance.

Any products sold by Global shall remain the personal property of Global until fully paid.

Prices are suggested list prices only and are subject to change without notice. Global will, however, attempt to keep dealer/purchasers up-to-date on all developments including price changes.

## Taxes

All prices shown in this book are exclusive of sales, use, excise and other applicable taxes and are the dealer/purchaser's responsibility as per the invoice issued by Global. If dealer/purchaser claims an exemption from such taxes, it shall be the dealer/purchaser's responsibility to furnish Global with an appropriate exemption certificate at time of order.

## Ordering Information

To avoid errors and/or duplication Global requires that all orders be submitted in writing. All orders submitted to Global in writing will be acknowledged on Global's acknowledgement forms governing the transaction. The details appearing on this acknowledgement will describe the items to be shipped and the approximate shipping date. It is the dealer/purchaser's responsibility to determine that the information in the acknowledgment is correct. In the event of an error, the dealer/purchaser must notify Global immediately by telephone followed by written confirmation. Shipping dates are assigned to orders based on the item having the longest manufacturing lead time.

When ordering, please provide the following information:

- 1) Account number (if possible)
- 2) P.O. number
- 3) "Bill to" and "ship to" name and address
- 4) Complete model number
- 5) Description
- 6) Options:
  - a. Upholstery fabric type and color (specify by name and number)
  - b. Color of paint finish, laminate or wood (if applicable)
  - c. Trim options (frame)
  - d. Arms
  - e. Base, Casters
  - f. Mechanism
  - g. Accessories

Dealer/purchaser is responsible for providing correct information when placing an order. Orders with incorrect information (finish, etc.) will be scheduled for manufacturing upon receipt of complete information.

All phone orders must be confirmed in writing by the customer within 7 days.

To prevent a delay in processing orders, please specify delivery routing.

## Changes and Cancellations

After the date of Global's acknowledgment of a dealer/purchaser's order, the order may not be changed or cancelled by dealer/purchaser without the written consent of Global. Special order items, C.O.M. and fabric-covered items already in production are not subject to change or cancellation under any circumstances. Fabric-covered items are considered to be in production once the fabric is scheduled for cutting. Other standard items already in production are subject to a minimum 35% cancellation charge.

## Errors and Omissions

All quotations, acknowledgements and invoices are subject to corrections for any errors and omissions.

## FINISHES

### Seating Finishes

Where painted frames are not a standard color, there is a one time charge of \$613 list price per-order for custom wood staining/color matching. Restrictions may apply. The customer must provide a 3" x 3" color chip/sample. Non-standard finishes must be approved by Global prior to acceptance of order.

### File Finishes

All non-standard finishes must be approved by Global prior to acceptance of order and may be subject to an upcharge.

Laminated Tops - Pricing for all non-standard finishes and sizes must be provided by Global Customer Service and may be subject to an upcharge.

## Desk Finishes

Because the distinctive characteristics and the nature of wood products cause variations, exact matches are not always possible.

Global has launched a finishes program between marketing companies within the Global Group to match products as best as possible when same finishes are specified.

## C.O.M. (Customers Own Material)

Use of Customer's Own Material must be approved by Global prior to acceptance of order. Please refer to page 408 of the Price Book and fill out the Authorization Request Form. Photocopy and use this form as often as necessary. The customer must provide a 12" x 12" fabric sample and advise how the fabric is to be applied.

**Fabric yardage requirement will be advised by the factory, and additional yardage may be required if pattern requires matching.** Yardage shown in the List Price Book does not allow for pattern repeat/matching.

Send to the address provided on shipping document upon approval from Global. If C.O.M. is difficult to apply or if product shall be modified, extra charges shall be made. Global reserves the right to cancel an order at any time if C.O.M. is inadequate for any reason. Customer's Own Material must be shipped freight and duties paid to our factory. Such shipment must be fully identified with purchaser's order number, RGA # provided by Global, and the item for which material is intended. Performance of C.O.M. when applied to product is the sole responsibility of the purchaser. Global's standard product warranty shall not apply to C.O.M. Use of C.O.M. will not reduce the published list price.

## Textile Grading

All products are priced according to their standard fabric and fabric grade. Lower grade fabrics are available (unless otherwise specified) at same price as standard.

The listing of prices for each model indicates the prices for higher upholstery grades. Prices are based on yardage in imperial measurements.

## TEXTILE PRICE GRADES - GLOBAL TEXTILES

### Grade Upholstery (Seating Fabrics)

1	Carrera, Fusion, Hudson, Jenny, Mock Leather, Quilt, Terrace, Urban, Waterfall
2	Allante FRee, Crescent, Elevate, Etch, GC Linen, Imprint, Match, Release, Renewal, Replay, Silhouette
3	Couture
5	Leather/Mock Leather Combination
8	Genuine Leather

### Grade Upholstery (Panel Fabrics)

1	Agate II
2	Coordinate, Lola
3	Accent, Brinx, Mariposa

The charts above do not include Textiles offered by Alliance Partners: Arc-Com Fabrics, CF Stinson, Designtex, Knoll Textiles, Green Hides, LDI Interiors, Luum Textiles, Maharam, Mayer Fabrics, Momentum, and Ultrafabrics.

## Upholstery Coverings

Slight variations in color may occur between dye lots. Although Global attempts to minimize these variances, they do occur and must be accepted as normal and will not be considered defects.

## Yardage

Required yardage (ydg) is based on unmatched materials with widths of 54" for seating, 63" for GPS panels. Yardage calculations are based on imperial measurements.

## Arms

A wide selection of arms are available for some series. See Arm Charts for details.

## Delays

Global's shipping confirmation will state a shipping date which is Global's best estimate at the time the order is acknowledged. However, Global shall not incur any obligation or liability to Purchaser for failure to ship by specified date unless Global has agreed to an unequivocal shipping date in a separately signed written document executed by its authorized personnel at its head office. In addition, Global shall not be liable for any loss or damage resulting from any delay or failure in shipment or other failure to perform all or any part of the agreement between the parties with respect to the goods shown on the face of the order acknowledgement where such delay, failure, loss or damage is the proximate result of any act of any governmental authority or political subdivision thereof, revolution, riot, civil disorder or disturbance, delay or default in transportation, strike disputes among or between labor unions or other labor disputes, delay or inability in obtaining materials and facilities, fire, flood, act of God or any cause not within the reasonable control of the company, whether of the class of causes enumerated or otherwise.

## F.O.B.

F.O.B. point is Global's Factory, Downsview, Ontario, Canada, or any Global Regional Distribution Center.

## UPS Shipments

Seating products marked with a UPS symbol are packaged for UPS-able shipments.

## Handling

A \$25. net handling charge per shipment will be applied for non UPS-able orders of less than \$2000. list.

## Special Delivery Requirements

Global's delivered pricing provides for dock delivery during normal business hours (considered to be 8 am to 4 pm Monday through Friday) to customer/end user only. Additional delivery requirements such as inside delivery, lift gate, limited access sites, installations and weekend deliveries will incur an additional expense and will be the responsibility of the dealer.

## Service

Service requests are normally the responsibility of Global's authorized dealers. Where this cannot be accomplished on a local level, service problems should be referred to Global's Customer Service Department in the nearest distribution center.

## Returns

No returns of goods will be accepted without written consent and shipping instruction of Global. A minimum re-stocking charge of 35% is made on all authorized returns for credit or refund, provided goods are received by Global in the condition in which they left the factory. This

may increase depending on the type of product. Global's Return Goods Authorization (R.G.A.) numbers must appear prominently on all authorized returns. Global will not be responsible for freight costs. No credit will be given if goods cannot be reused as new. Special order items, non-stock items and C.O.M. products are in no event subject to return. All returns must be approved and authorized in writing by Global Customer Service. Global reserves the right to refuse delivery of any unauthorized returns.

## Claims

All goods are sold F.O.B. plant or Global Distribution Center. Global is not responsible for damage which occurs in transit (or in storage). The carrier signs for all goods received in apparently good order. It is the dealer/purchaser's responsibility to examine goods upon receipt and to file any claims with the carrier for losses or damage to the product occurring during transit, including concealed damage.

Any claims made against Global for apparent defects, errors or shortages must be made by the dealer/purchaser, in writing, within 15 working days after any delivery. Failure by the dealer/purchaser to make any claim against Global within 15 days shall constitute acceptance of the goods and a waiver of any apparent defects, errors or shortages.

## Suspension

In the event that the dealer/purchaser defaults in the payment of any sum due to Global, or in the event the dealer/purchaser's financial condition becomes unsatisfactory to Global, Global shall have the right to defer or discontinue shipment of any goods until such time as the default is cured or the dealer/purchaser provides assurance of payment to Global.

## Copyright

All catalogs, photographs, drawings, price lists and other printed material are protected by copyright. All rights reserved.

## Trademarks

All trademarks are owned by GlobalFurniture Group other than OBUSFORME™ which is owned by OBUSFORME LTD. and are used under license. OBUSFORME® and the distinctive backrest design are registered trademarks of OBUSFORME LTD.

## Designs and Patents

Many of the products produced by Global are protected by design registrations, design patents and/or patents. Design and specifications are subject to change, discontinuance or additions without notice.

## Cubic Measure

The stated cubage is an approximate cubic foot measure to calculate freight costs. The figure shown is the volume for one carton and is subject to change without notice. It is most economical to purchase the specified number per carton.

## Combined Shipments

Global will make every effort to combine shipments and orders on written request. However, Global cannot be held responsible where such request is not complied with.

## Offer of Sale

Possession of this price list or any other literature shall not imply the company's willingness to sell to the holder and shall not be construed as a direct offer of sale.

If a conflict arises between: (i) prices found in software support packages furnished to the customer by Global or by any other source on behalf of Global; and (ii) Global's current printed price lists, then the most current shall prevail.

## Disclaimer

All dimensions are in inches. Prices shown are current manufacturer's suggested list prices at the time of printing. All applicable taxes are extra. Descriptions, specifications and prices are subject to change without notice. Errors and omissions are subject to correction.

## Flammability

The foam used in Global chairs meets the requirements of California TB117. In addition to the foam, upholstery materials must also meet the California TB117 smolder resistant requirements. Please contact Customer Care to determine if a selected textile meets the California TB117 requirement.

## This list price book is effective as of March 1, 2019.

For periodic updates, please check the PDF at [www.globalfurnituregroup.com](http://www.globalfurnituregroup.com). After login, select INFORMATION, then GLOBAL, and then PRICE BOOK/ PRICING. Global warrants that all commercial products are free from defects in material and workmanship, for the life of the product, to the original purchaser.



# LIFETIME WARRANTY

Global will repair or replace, at Global's option, as the sole remedy for any defect covered by the warranty. The warranty applies to products manufactured after January 1, 2011.

## General Commercial Seating

Global's warranty for general commercial seating covers all chair components including pneumatic cylinders, bases, casters, glides, frames, arms, plastic seats, backs and other structural components.

Exceptions to the warranty for general commercial seating are as follows:

- Foam, textiles (as sampled on Global branded and textile program cards), mesh material and electrical devices, are warranted for five (5) Years
- Control mechanisms are warranted for twelve (12) Years

The warranty applies to single shift, standard commercial usage, defined as a standard eight (8) hour day, forty (40) hour week for users weighing up to 300 pounds. ObusForme Comfort XL falls under the General Commercial Seating Warranty with the exception the weight rating is for users up to 400 pounds.

## Heavy Duty Seating

Global offers products designed for multiple shift applications (24 hours a day / 7 days a week) and larger individuals weighing up to 350 and/or 500 pounds (depending on series and/or model). Global warrants these products for twelve (12) years to the original purchaser. All components (including control mechanisms, pneumatic cylinders, bases, casters, glides, frames, arms, plastic seats/backs, etc.) are covered for 24/7 applications under the warranty. The exceptions are foam and textiles, which are covered for five (5) years. Textiles on these products must exceed 100,000 double rubs for the textile portion of the warranty to apply. Heavy Duty product series that apply under this warranty currently include: Concord Executive 24 hour, Dexter/Dexter+, Granada TS, Granada Deluxe TS, Malaga TS, ObusForme Comfort TS, River HT, Robust, Saxon, Truform TS, and Vion TS.

## Textiles

Global warrants Global branded textiles and Alliance Partner carded textile programs inclusive of fabrics, vinyls and leather products for five (5) years. Alliance Partner carded textile programs are currently with Arc-Com Fabrics, CF Stinson, Designtex, Knoll Textiles, Green Hides, LDI Interiors, Luum Textiles, Maharam, Mayer Fabrics, Momentum, and Ultrafabrics. Global does not warrant COM (Customer Own Materials) or graded-in materials (non-carded) and purchased by Global for a customer. For graded-in or COM products, please contact the textile supplier for performance information and warranty details.

## Seating Warranty Summary

Seating Type	Components Warranty For Original Purchaser	Use Time For Warranty Coverage	Exceptions
General Commercial Seating	Lifetime	8 Hours/5 Days Per Week	Foam/Textiles/Mesh/Electrical Devices - 5 Years Control Mechanisms - 12 Years
Heavy Duty Seating	12 Years	24 Hours/7 Days Per Week	Foam/Textiles - 5 Years

## Files, Desks, Modular Furniture, Tables, Panels & Accessories

Global warrants all components of metal storage and filing, laminate and wood veneer desks, laminate and wood veneer tables, metal leg components and panels for the lifetime of the product to the original purchaser.

Exceptions to the warranty for Files/Desks/Tables and Panels are as follows:

- Electrical devices, panel and tackboard textiles, adjustable keyboard mechanisms/lecterns/coat trees and task lights – five (5) Years
- Folding tables (laminate and Lite Lift II models) – one (1) Year

## Files, Desks, Modular Furniture, Tables, Panels & Accessories Warranty Summary

Product Type	Components Warranty For Original Purchaser	Exceptions
Metal Storage and Filing	Lifetime	None
Laminate/Wood Veneer Desks and Modular Furniture	Lifetime	Tackboard Textiles , Electrical Devices,Task Lights - 5 Years
Productivity Solutions - Foli + FreeFit Height Adjustable Tables	Lifetime	Steel components - 10 Years, Moving components - 5 Years, All electrical components - 2 Years
Boardroom, Conference and Training Tables	Lifetime	Electrical Devices - 5 Years
Panels	Lifetime	Panel Textiles, Electrical Devices, Task Lights - 5 Years
Coat Racks and Lecterns	5 Years	None
Folding Tables (Laminate & Molded)	1 Year	None

## Global's Warranty does not apply (for any product category) to the following:

- Failures due to wear and tear
- Failures which result from negligence, abuse, accident or misuse
- Failure to apply, install or maintain products according to Global's written instructions and warnings
- Modifications, attachments or repair methods not approved by Global
- Damage caused by a carrier in transit, or delivery/installation contractors
- The matching of colors, grains or textures (wood, leather, etc.) of natural materials and color matching of textiles
- Products exposed to extreme hot or cold temperatures or excessively dry or humid environments
- Colorfastness or the matching of color of textiles
- Damage by markings or staining; damage by sharp objects or imprinting from instruments
- Damage to textiles or laminate and wood surfaces/edges from exposure to sunlight (including UV rays)
- Products used for rental purposes

Global's warranty does not cover the costs of transportation or labor. Repair or replacement will be at Global's option.

Global makes no warranty that any of its products are suitable for any particular purpose and makes no other warranties, express or implied, other than those set out here. As codes and standards vary from one jurisdiction to another, references to compliance are solely for convenience and without any representation as to accuracy or suitability. Users must verify the suitability of such information or product for their specific application. In no event shall Global be liable in either tort or contract for any loss or direct, special, incidental, consequential, or exemplary damages.

Global's warranty applies to products sold within the United States of America, Mexico, the Commonwealth of Puerto Rico and Canada.